

Centre for Archaeological Fieldwork
School of Geography, Archaeology and Palaeoecology
Queen's University Belfast



CAF Data Structure Report No. 042
Excavations at Aghaloo Church, Rousky, County Tyrone

AE/05/116

On behalf of





Excavations at Aghaloo Church, Rousky, County Tyrone

Naomi Carver (with a contribution by Steven Trick)

CAF DSR 042
Licence No: AE/05/116
SMR No: TYR 060:016
H 6633 5493

Contents

List of Figures	I
List of Plates	II
Chapter 1: Summary	1
Chapter 2: Introduction	5
Chapter 3: Geophysical Survey (Steven Trick)	15
Chapter 4: Excavation	23
Chapter 5: Discussion	33
Chapter 6: Recommendations for Further Work	35
Bibliography	37
Appendix 1: Context List	38
Appendix 2: Harris Matrix	40
Appendix 3: Photographic Record	41
Appendix 4: Field Drawing Register	45
Appendix 5: Finds Register	47
Appendix 6: Samples Register	48
Appendix 7: Soil Residue Report	49
Plates	50

Figures

Figure One:	General location map
Figure Two:	Detailed location map
Figure Three:	Plan of graveyard showing distribution of graves
Figure Four:	Bartlett Map (1609)
Figure Five:	Location of geophysical survey grids
Figure Six:	Results of the resistivity survey
Figure Seven:	Results of the magnetometry survey
Figure Eight:	Interpretation of resistivity survey showing anomalies
Figure Nine:	Resistivity survey overlaid on modern location map
Figure Ten:	Resistivity survey overlaid on 1973 map
Figure Eleven:	Interpretation of the magnetometry survey
Figure Twelve:	Magnetometry survey overlaid on modern location map
Figure Thirteen:	Magnetometry survey overlaid on 1973 map
Figure Fourteen:	Plan of trench showing excavated features
Figure Fifteen:	Sections through post-holes (Context Nos. 139 and 143) and profile through pit (Context No. 135)
Figure Sixteen:	East facing section through ditch (Context No. 132)
Figure Seventeen:	West facing section through ditch (Context No. 132)
Figure Eighteen:	Profiles through post- and stake-holes in northern part of site (Context Nos. 117, 119, 121, 123, 125, 128 and 130)

Plates

- Plate One: Apex of eastern gable of church (looking east)
- Plate Two: Relict window tracery exterior of eastern gable of church (looking west)
- Plate Three: Probable graveyard soil banked up against gateposts in graveyard (looking north-west)
- Plate Four: Bank material in north-western area of graveyard (looking north-west)
- Plate Five: Mortared stones in wall of graveyard boundary (looking north)
- Plate Six: Hearth feature (Context No. 127) following removal of half of fill (Context No. 109) (looking south-east)
- Plate Seven: Post-hole (Context No. 139) within hearth feature (Context No. 127), prior to excavation (looking south-west)

1 Summary

1.1 Background

1.1.1 Aghaloo Church (SMR No. TYR 060:016, Grid Reference H 6633 5493) is located in County Tyrone, just outside the town of Aughnacloy. The church was built in the seventeenth century, although there is some dispute as to exactly when. According to one source the church was in the process of being built in 1622 (Leslie 1911, 86), whereas another notes that it was erected around 1661 (Marshall 1925, 29). The church survives as a ruin, occupying a commanding position in a landscape of drumlins. It is surrounded by a D-shaped enclosure within which is a graveyard. The documentary sources do not refer to an Early Christian ecclesiastical centre in this area and it is uncertain whether the church is built upon earlier remains. An early map (Bartlett 1609) shows a church on the site, possibly without a roof, which suggests it was the focus of earlier ecclesiastical activity. Ann Hamlin has speculated on an early date for ecclesiastical activity at Aghaloo Church and notes that apart from the bank enclosing the graveyard, no other early material is visible (1976, 763). The headstones in the graveyard date from the early eighteenth century onwards and the graveyard is still used for burial occasionally.

1.2 Objectives

1.2.1 The excavation took place as a follow-up to an evaluation which was undertaken in September 2005. The evaluation was carried out in advance of the installation of a slurry tank by the landowner. The principal objective of the excavation was to investigate a linear negative feature, thought to be a ditch. It was intended that a 2.0 metre wide cutting was excavated across the feature to ascertain its character and date. The excavation was to be augmented by a small-scale geophysical survey, the main aim of which was to trace the continuation of the possible ditch.

1.3 Geophysical survey

1.3.1 The geophysical survey highlighted some interesting anomalies but failed to trace the continuation of the ditch in the area to the north-east of the site. This could be because the ditch does not continue much further than the excavated area, that it changes direction, or that the geophysical techniques applied did not detect the feature. A linear

anomaly detected by both the resistivity and magnetometer surveys probably equates to a field boundary removed in recent years.

1.4 *Excavation*

1.4.1 The excavation area consisted of a rectangular trench 10.0m by 15.0m. The long axis of the trench was aligned north-west/south-east. The trench was bounded on the south-west and south-east sides respectively by a barn and an outhouse. To the north-west and north-east was a field.

1.4.2 Five main phases of activity were identified during the excavation. The earliest phase related to a hearth feature (Context No. 127) which consisted of a hollow cut into the subsoil. The hearth had two post-holes (Context Nos. 139 and 143) associated with it, which may have formed part of a hearth superstructure. Overlying the post-holes, and probably also part of the earliest phase, was a charcoal-rich deposit (Context No. 109). The second phase of activity consisted of a linear feature (Context No. 132) being cut across the site. The linear feature, probably a ditch, was cut through the fill of the hearth feature (Context No. 109) and this resulted in slump from the latter (Context Nos. 109s and 147) fill the base of the ditch. During the third phase three successive fills either accumulated or were deposited within the ditch. The lower two fills (Context Nos. 150 and 151) were probably the result of the feature beginning to naturally silt up, while the uppermost fill (Context No. 115) was homogenous and more likely to have been the result of one episode of dumping.

1.4.3 The fourth phase of activity consisted of a dump of clay (Context No. 105) and two agricultural furrows (Context Nos. 137 and 138), one of which had a pit cut into it (Context No. 135). This phase was probably relatively recent in date as the dump contained seventeenth and eighteenth century pottery (Ruairí Ó Baoill *pers. comm.*). The furrows and dump were below a mixed cultivation soil (Context No. 103) which was present over the whole site. The cultivation soil also overlay a group of negative features comprising a pit (Context No. 116) and seven post- and stake-holes (Context Nos. 117, 119, 121, 123, 125, 128 and 130). These features were stratigraphically isolated from the other features in the trench and cannot be closely phased within the site's stratigraphic sequence.

1.4.4 The final phase of activity on the site was the result of modern building work and installation of services. A number of pipe trenches (Context Nos. 111, 112 and 148) cut across the trench but disturbance of the underlying archaeological features was minimal.

1.5 *Discussion*

1.5.1 The main feature uncovered during the excavation at Aghaloo Church was a ditch (Context No. 132). The feature was linear with steeply sloping sides and a slightly concave base. It was approximately 0.60m deep and 3.5m wide and ran west south-west/east north-east across the excavated area. The uppermost fill (Context No. 115) of the ditch (Context No. 132) contained burnt bone. Preliminary post-excavation sieving of soil samples from the slumped deposit (Context No. 147) detected probable iron tap slag which was presumably derived from the hearth feature (Context No. 127). The ditch was probably the truncated remains of a bank-and-ditch field boundary.

1.5.2 The hearth feature (Context No. 127) and the post-/stake-hole group (Context Nos. 117, 119, 121, 123, 125, 128 and 130) were possibly contemporary and the latter may have formed part of a superstructure for the hearth; perhaps in the form of a windbreak to protect the fire from the wind. The exact nature of the hearth feature (Context No. 127) is unclear as there was little evidence of *in situ* burning. The densely charcoal-rich fill of the post-holes (Context Nos. 139 and 143) within the base of the feature suggests, however, that the posts may have been burnt *in situ*. The post-holes were obscured by a layer of charcoal-rich silty clay (Context No. 109) which may have been derived from burning elsewhere and dumped into the hearth feature when it had fallen into disuse.

1.5.3 Although the exact nature and date of the archaeological features present at Aghaloo Church are not as yet fully understood, the investigation at the site revealed a concentration of activity in the area to the north-east of the church. In the absence of absolute dates it is not possible to define the nature of the temporal relationship of this activity with the church.

1.6 *Recommendations for further work*

1.6.1 It is intended that the Aghaloo excavation is published in the *Ulster Journal of Archaeology*, pending the results of post-excavation work. Preliminary soil sample processing has demonstrated that some of the archaeological features contain charred grain as well as metalworking debris. It is therefore recommended that further work is

carried out in five main areas. These areas are: processing of soil samples; radiocarbon dating; evaluation of slag, analysis of macrofossil remains; and analysis of animal bone.

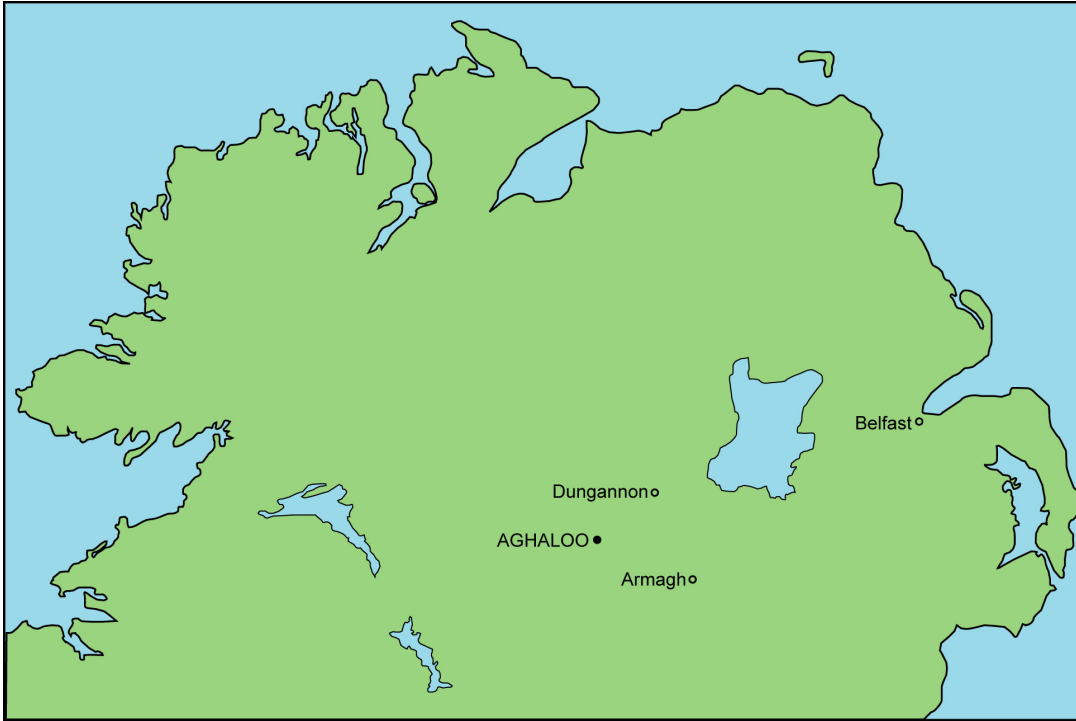
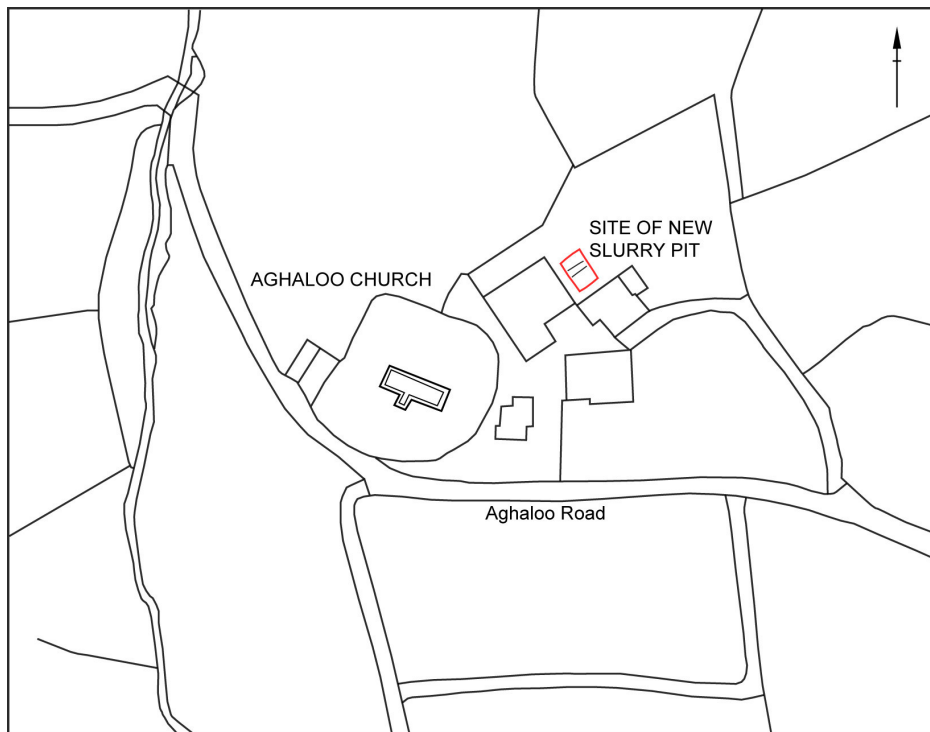

Figure One: General location map



0 125 metres

Figure Two: Detailed location map

2 Introduction

2.1 General

2.1.1 The following report details the preliminary results of the excavation at Aghaloo Church, Rousky, County Tyrone, undertaken by Naomi Carver of the Centre for Archaeological Fieldwork, School of Geography, Archaeology and Palaeoecology at Queen's University Belfast. The fieldwork took place between the 19th October and the 3rd November 2005 and was preceded by a three day evaluation between the 19th and the 21st September 2005 (CAF Monitoring Report No. 028). Both components of fieldwork were carried out under Licence Number AE/05/116. The work was undertaken on behalf of the Environment and Heritage Service: Built Heritage.

2.2 Background

2.2.1 Aghaloo Church (SMR No. TYR 060:016, Grid Reference H 6633 5493) is situated in County Tyrone, approximately 3km north-northwest of the town of Aughnacloy and 3km west of Carnteel village. The church and associated graveyard occupy the top of a drumlin at a height of approximately 100m above sea level. This situation offers commanding views in all directions, particularly to the south where the valley of the river Blackwater is visible. The church is situated slightly off-centre within a D-shaped graveyard. The church itself is in a ruinous state. It is rectangular in plan with the long axis aligned E-W. It is approximately 22.0m long and between 8.0 and 8.5m wide. The walls of the church are up to 1.0m thick and built of roughly cut rectangular and square blocks of sandstone bound together with a cream-coloured lime mortar. There is a 2.5m wide entrance gap in the southern wall where a small annex is present. The western end of the church is covered in ivy and there is a tree growing in its south-western corner. In this area the walls stand at a maximum height of 2.5m although in some places they are only a few courses high. The eastern gable of the church is relatively intact and stands to a height of approximately 6.0m (Plate One). In the centre of the wall there is a large gap where originally the window would have been situated. Relict segments of window tracery are visible on both the interior and exterior in this area (Plate Two). The apex of the eastern gable wall is in a fragile condition; a substantial amount of rubble at the base of the gable was probably derived from this wall. The northern and southern walls of the church stand at an average height of 3.0m and there several discernable gaps with upstanding masonry on either side which suggest the presence of further window openings.

- 2.2.2 The roughly D-shaped graveyard in which the church is situated is approximately 50.0m (N-S) by 40.0m (E-W) in dimension (Figure Three). The boundary consists of a hedge planted on a small bank. In places there is rubble visible within the bank consisting of stones which in some cases are mortared together. This suggests that in some parts the bank is revetted. The entrance to the graveyard is through a small gate in the western boundary. There is an accumulation of material, possibly graveyard soil, banked up against the gate posts in this area (Plate Three). On the western side in particular the slope of the bank is more pronounced and as there are burials in this area it is probably the result of an accumulation of graveyard soil (Plate Four). In places the graveyard boundary has been built up with a concrete wall beneath, suggesting that although the line of the boundary may be of some antiquity, sections may have been repaired relatively recently (Plate Five). The topography of the graveyard area is in some parts quite pronounced. This is probably only partly related to the accumulation of graveyard soil from burials and more to do with the site's situation on the top of a drumlin. Burials are present mainly to the east, south and west of the church. The northern part of the graveyard is empty of headstones and relatively flat, suggesting that there are no burials in this area. During the excavation there was standing water present in this part of the graveyard and poor drainage may have been the reason this area has not been used for burial. The majority of the headstones are twentieth century in date, although, there are also a number from the nineteenth century. The interior of the church has been utilised for later burials, the earliest of which is 1880. The earliest burials, marked by headstones, in the graveyard are outside the eastern wall of the church. The headstones date from the eighteenth century and the earliest legible inscription is 1729.
- 2.2.3 The excavation took place in advance of the installation of a slurry tank by the landowner, Mr Wildridge Coote. The intended location of the tank was approximately 50.0m to the north-east of Aghaloo Church. The excavation area was located to the rear of a large barn which is set at right angles to a smaller outhouse. It is in a flattish, polygonal shaped field. The ground rises quite steeply to the east to the peak of a drumlin. The barn and outhouse make up part of the western and southern sides of the field while to the north and north-west is further agricultural land which drops away. The site is poorly drained which is probably due to the underlying impermeable boulder clay and the presence of a small spring to the north-west. The field is currently used as pasture although it has been ploughed in the past.

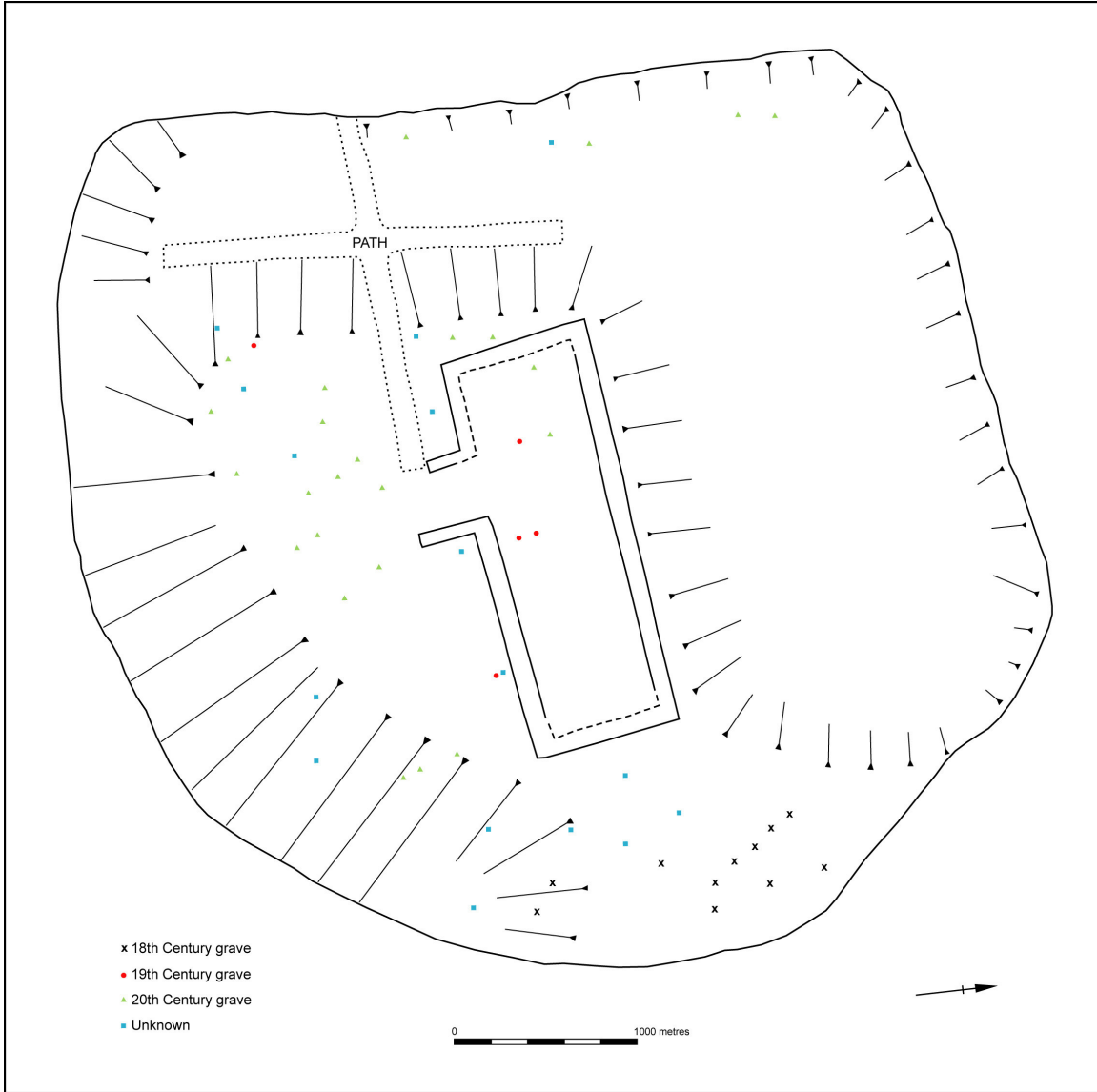

Figure Three: Plan of graveyard showing distribution of graves

2.3 *Place-name evidence*

2.3.1 Aghaloo Church is in the civil parish of Carnteel but was originally in the parish of Aghaloo (see Section 2.4). The Irish form of the name, *achadh Lugha*, is said to mean Lewy's Field (McAleer, 1925, 36) or perhaps Lugha's field (Leslie 1911, 86). It is not known who 'Lewy' or 'Lugha' was. Documentary sources mention a number of variations on the modern day place-name including: Aghalow, Aughaloo, Aughaloe, Achlounge, Achalunga, Acculunga, Aghaloe and Aghelow. The original name of the parish may have been Fonyglassce or Fynglass (*fionn ghlaise*), the meaning of which is 'a bright streamlet' (McAleer 1925, 36).

2.3.2 The parish of Carnteel has also been known by many different names since the Medieval period. In the early fourteenth century Ecclesiastical Taxation it is known as Karmesgell. The name probably developed to Carnesheyll, Garndsegayl, Carnetiell and Carneteale with variations in spelling. Lewis refers to the parish by the name of Carrenteel (Lewis 1837, 267). Carnteel probably means Shiel's Carn or *carn t-Siadhail* (McAleer 1925, 44).

2.3.2 The townland name of Rousky is commonly used throughout Ireland, with several examples known from County Donegal and elsewhere in County Tyrone. The Irish for Rousky is *rusgaidh* meaning marshy or fenny land (McAleer 1925, 45).

2.4 *Historical background*

2.4.1 The history of the parish of Aghaloo is complex. The earliest reference to the parish is in Swayne's Register of 1438 (Thom Kerr *pers. comm.*) where it is named *Achlouge*. There is some evidence, however, that the parish of Fonyglassce mentioned in the Ecclesiastical Taxation of 1302-6 may have been its original name. Aghaloo can be traced through various documentary sources including the Annates, the sixteenth century Visitations and the Civil Survey of 1652-4. However, there is no firm evidence of a church on the site before the early seventeenth century. The Bartlett maps of 1609 show a church (Figure Four) with attached ecclesiastical lands (*tamlaght*). The church is apparently shown without a roof, suggesting that it was a ruin, but as other churches on this map are shown in a similar manner, this may simply have been a drawing convention. The townland of Rousky is not depicted on this map, although other townlands in the immediate vicinity are identifiable and can be equated with present-day townlands. For example, 'Cargirry' is Corderry and 'Cavangalgren' is Cavankilgreen. Aghaloo parish is also shown on the Down Survey Map (1654-60) as 'Aghallow'. Ann

Hamlin speculated on an early date for the site, commenting that although remnant banks and ditches are visible at the site, there is no other early material present (1976, 763).



Figure Four: Bartlett Map (1609) showing a church at Aghaloo (circled in red) (after James 1861)

2.4.2 Aghaloo church is now within the civil parish of Carnteel which can trace its origins at least as far as the Medieval period. It is mentioned in the Ecclesiastical Taxation of 1302-6 and there was a church on the site at this time. The current church in Carnteel village probably dates no earlier than the sixteenth century (Davies 1941, 150). A church shown in the townland of Plaister on the Bartlett map (Figure Four) was probably that of Carnteel as no mention of a church in Plaister townland is extant in the historical records.

2.4.3 The church of Carnteel was destroyed during the rebellion of 1641 although some of its remains are still visible and the graveyard continued to be used. In August 1661 Hugh Barclay, who had been the Rector of Carnteel before the rebellion, received possession of the parishes of Killeeshil and Carnteel. It was necessary in some circumstances to unite several parishes if the Rector was to make an adequate living (Marshall 1925, 29). Marshall notes that during this time or shortly after, the parish church in the townland of Rousky was built. Leslie notes that the church was being erected in 1622, some 40 years later “Church is in building, no [glebe] building by reason ye glebe is inconvenient” (1911, 86). Despite this confusion we know that the church was out of use by around 1736; indeed at Easter Vestry held at Aghaloo Church in May of this year it was ordered

that “every townland in this parish is to send their horses and their cars to carry the flags (stones) of this present church to Augnacloy on Monday, the 10th May, next.” (Marshall 1925, 31). The following year Easter Vestry was held in the parish Church of Aughnacloy.

- 2.4.4 In the early seventeenth century the parish of Aghaloo covered a much larger area than it does today. When the new parish church was to be built a site was chosen near the upper end of Aghaloo parish in the townland of Rousky. Marshall notes that the parish was known as ‘Carnteale’ from 1712 onwards (1925, 29). In 1679 a number of parishioners who lived at Kenard petitioned the primate saying that they were unable to attend the church, mainly because it was too far away. It was therefore recommended that Carnteel, the upper part of Aghaloo and Killeeshil, should be united, and that the church of Aghaloo should continue to serve as a parish church. A new parish church was built near Caledon and this became the parish church of Aghaloo. The church at Rousky continued to serve for Killeeshil until 1732 when the latter was separated from the other two parishes. The parishes of Carnteel and the upper part of Aghaloo remained united, with the church at Rousky used as the main place of worship.

2.5 *Geological and Soil Background*

- 2.5.1 Aghaloo Church is situated in an area with a complex geological history, the stratigraphy of which is not accurately defined in places due to poor exposure (Mitchell 2004, 103). The solid geology consists mainly of Upper Palaeozoic deposits from the Carboniferous and the Devonian periods. The Clogher Valley Fault is immediately to the south-west of the site and there are numerous smaller faults present in the local area. The site itself is on a sedimentary rock, limestone, of the Maydown Limestone Formation which is exposed in Plaister quarry, 1.0km to the south-east (*ibid.* 103). There are other sedimentary deposits in the immediate area including the Carrickaness Sandstone Formation upon which Carnteel is located, the Bundoran Shale Formation and the Gortfinbar Conglomerate Formation. To the west of the site, Ballygawley is situated on conglomerate and sandstone bedrock of the Ballyness Formation while the Clogher Valley Formation of peritidal limestone and shale exists to the north.
- 2.5.2 The drift geology in the vicinity of Aghaloo church consists predominantly of glacial till (tenacious clays with variable pebble content). In some places the bedrock is at or near to the surface. Further downslope are deposits of alluvium from ancient river valleys and lakes. The predominant soil type on the site, therefore, is calp till. This has poor drainage

and there is also limestone till and organic alluvium nearby both with impeded or poor drainage.

2.6 *Sites of archaeological interest in the surrounding area*

2.6.1 The area of County Tyrone where Aghaloo Church is situated is rich in antiquities spanning several periods. Within 3.0km of Aghaloo Church there are two raths, two enclosures, a henge and a tree ring (which may have been built on an existing rath). A summary of the sites is tabulated (Table One). The ecclesiastical history of County Tyrone is also rich. The church of Carnteel whose history is intertwined with that of Aghaloo lies approximately 3.0km to the east while the early church site of Killeshil is approximately 4.0km to the north-east.

<i>Type</i>	<i>SMR No.</i>	<i>Townland</i>	<i>Grid Reference</i>
Tree ring	TYR 060:015	Plaister	H 67845439
Henge	TYR 060:017	Golan	H 66165677
Enclosure	TYR 060:018	Golan	H 65785665
Rath	TYR 060:031	Drone	H 66005431
Rath	TYR 060:032	Glack	H 66915424
Enclosure	TYR 060:034	Killyneery	H 66865524

Table One: Sites of archaeological interest in the vicinity of Aghaloo Church

2.7 *Summary of cartographic evidence*

2.7.1 The first edition of the Ordnance Survey six inch map (1834) shows the ground-plan of Aghaloo Church as a rectangular outline with an annex on its southern side, much the same as it exists on the ground today. The church is set within a D-shaped graveyard. Few field boundaries are shown but such features are commonly absent from the first edition Ordnance Survey six inch map. The current collection of farm buildings are not shown but to the north-west of the church is a cluster of buildings of which only a ruined outhouse remains. The map also shows a well to the north-east of the church and although there is no evidence to suggest that this was a Holy well, it is possible that it was utilised in such a manner.

2.7.2 The field boundaries and layout of farm buildings on both the 1907 six inch edition and the 1973 revision (1:2500) differ from the present layout. This indicates that the current arrangement of farmhouse, outbuildings and field boundaries post-dates 1973. Both

maps show a no longer extant field boundary crossing the site immediately to the south-east of the area of excavation (see Chapter 3).

2.8 *Reason for Excavation and Research Objectives*

2.8.1 The excavation took place as a follow-up to an evaluation which was undertaken in September 2005 (CAF Monitoring Report No. 028). The evaluation was carried out in advance of the installation of a slurry tank by the landowner. It was thought that the site merited investigation due to its proximity to a late Medieval church, which may have been sited on an earlier ecclesiastical foundation.

2.8.2 During the evaluation an area of 15.0m by 10.0m was mechanically excavated to the subsoil which was a orange calp till. A number of features were identified cut into the subsoil. These included a linear negative feature, thought to be a ditch, agricultural furrows and a group of pits, post- and stake-holes (refer to CAF Monitoring Report No. 028). The primary aim of the excavation was to try and ascertain the character and date of the ditch. It was proposed that this would be done by excavating a 2.0m cutting across the ditch which would be accompanied by a small-scale geophysical survey with the intention of tracing the continuation of this feature.

2.9 *Archiving*

2.9.1 Copies of this report have been deposited with the Environment and Heritage Service, DOE NI. All site records and finds are temporarily archived within the Centre for Archaeological Fieldwork, School of Geography, Archaeology and Palaeoecology, Queen's University Belfast.

2.10 *Credits and Acknowledgements*

2.10.1 The excavation was directed by Naomi Carver and supervised by Brian Sloan. The excavation team consisted of Cormac Duffy and Lauren Mansell. The geophysical survey was carried out by Steven Trick with the assistance of members of the excavation team.

2.10.2 Assistance during the course of the excavation and the preparation of this report was kindly provided by: Norman Crothers (Archaeological Development Services Ltd); John Davison (Queen's University Belfast); Colm Donnelly (Queen's University Belfast); Thom Kerr (Queen's University Belfast); Philip Macdonald (Queen's University Belfast); Ronan

McHugh (Queen's University Belfast); Cormac McSparron (Queen's University Belfast); Ruairí Ó Baoill (Queen's University Belfast) and Maura Pringle (Queen's University Belfast). The plan of the church and graveyard was drawn by Lauren Mansell and all drawings were prepared by Ruth Logue of the Centre for Archaeological Fieldwork, Queen's University Belfast. The appendices were compiled by Brian Sloan.

2.10.3 Thanks and appreciation is especially due to the landowner, Wildridge Coote, and his family who were encouraging and supportive throughout the excavation.

3 Geophysical survey (*Steven Trick*)

3.1 Introduction

3.1.1 Excavations at the site of the proposed slurry tank revealed evidence of a substantial linear ditch running across the trench in a north-east/south-west direction. Geophysical survey techniques were applied to explore the continuation of the ditch outside the bounds of the excavated area. A 20.0 x 20.0m area of the field (Grid A) was surveyed with both resistance and magnetometry techniques. In addition, an adjacent 20.0 x 20.0m area (Grid B) was surveyed, although this was necessarily a partial grid due to the presence of spoil heaps from the excavation trench (see Figure Five).

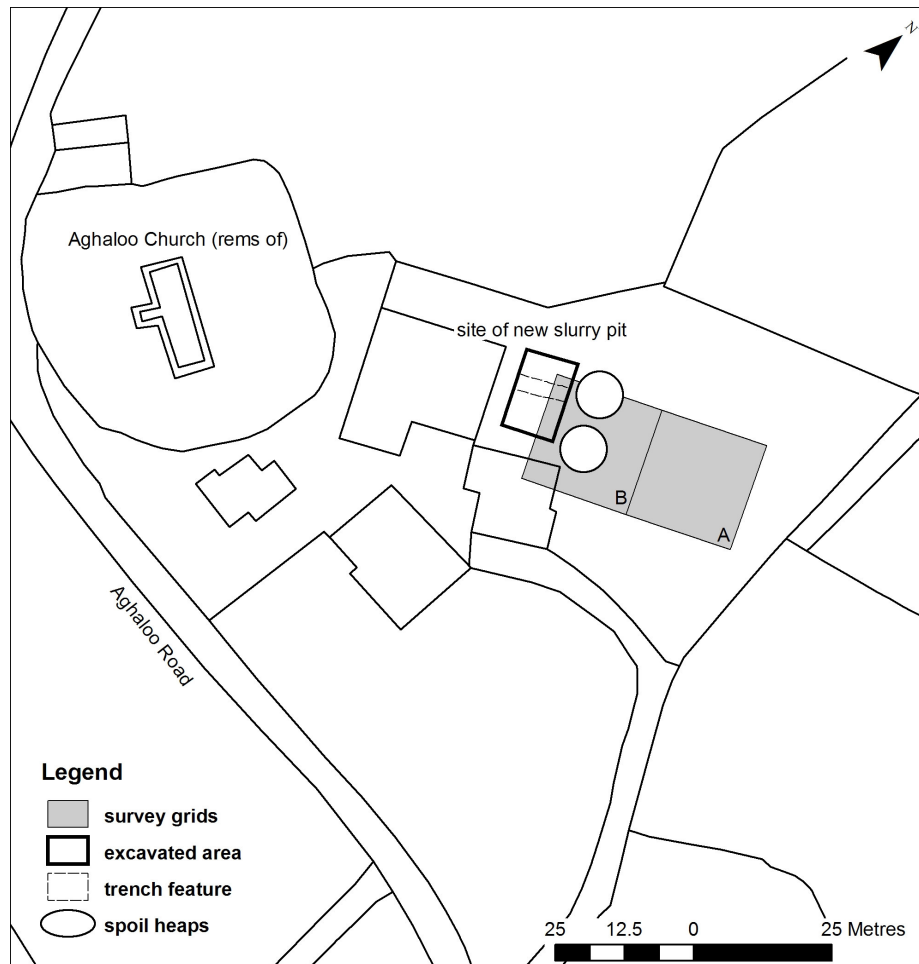

Figure Five: location of survey grids (oriented to local grid)

- 3.1.2 The geophysical survey took place over two days in October 2005. The weather during this time was overcast and rainy. The ground was waterlogged and in low lying areas there were pools of standing water. A plastic pipe ran across half of Grid A, and occasionally water would issue from this pipe, contributing to the sodden ground conditions. Old farm machinery lay at the edges of the field, although at a distance where it was unlikely to affect the magnetometry survey.
- 3.1.3 As outlined in Chapter 2, section 2.5, the solid geology of the area consists of Upper Palaeozoic deposits from the Carboniferous and Devonian periods. The site itself is located on sedimentary rock of the Maydown Limestone Formation. The drift geology consists mainly of glacial till consisting of clays with pebbles. These soils typically offer poor drainage potential.

3.2 *Methodology*

3.2.1 Resistivity

- 3.2.1.1 An earth resistance survey was conducted as this was technique deemed most suitable for the location of subsurface ditches. The earth resistance survey equipment consisted of a Geoscan RM15 resistance meter in the twin-probe array, with a probe separation of 0.5m. The grids were surveyed in a zig-zag pattern, with a traverse interval of 1.0m, and a sampling interval of 0.5m, resulting in 800 readings per grid. The survey data were downloaded and processed with ArchaeoSurveyor, and visualised with Surfer Software. Figure Six shows the results of the resistance survey. This plot was clipped to 2 standard deviations to give better contrast, and interpolated (Kriging) to give a smoother appearance.

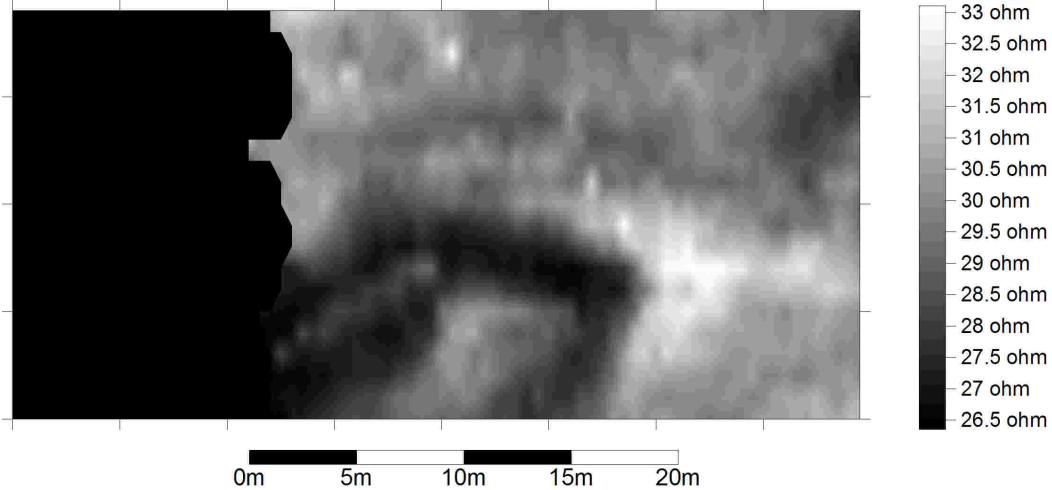

Figure Six: Resistivity survey. Clipped to 2 standard deviations and interpolated. Black area denotes dummy values inserted due to obstructions in the grid (spoil heaps)

3.2.2 Magnetometry

3.2.2.1 The magnetometry equipment consisted of a Bartington Grad601-2 dual sensor fluxgate gradiometer, with a probe separation of 1.0m. Grids were surveyed in a zig-zag pattern, with a traverse interval of 1.0m, and a sample interval of 0.25m. Grid B was surveyed in a parallel pattern however, due to the cramped conditions around the spoil heaps. The survey data was downloaded with the Grad601 application and processed with Geoplot 3.0p, and visualised in Surfer. The data was clipped from -5nT to 10nT to provide better contrast in the plot. Figure Seven shows the results of the magnetometry survey.

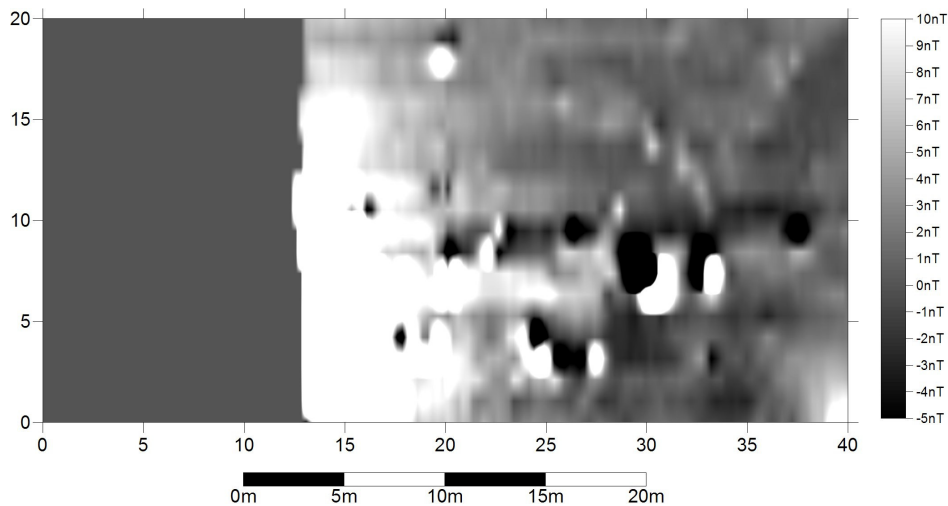

Figure Seven: Results of the magnetometry survey. Plot interpolated in Surfer (Kriging)

3.3 Results

3.3.1 Resistivity

3.3.1.1 Figure Eight shows a graphical summary of the geophysical anomalies discussed in the following text.

3.3.1.2 The patterning at (i) is a low resistance anomaly 3.0-4.0m across. It perhaps represents a negative cut feature such as a ditch. The sharp angle through which it proceeds on its eastern side adds weight to the suggestion it is of anthropogenic origin. Abutting this angular section of anomaly (i) is a high resistance anomaly (ii), which proceeds eastwards in a linear fashion. The response is suggestive of a feature such as a low bank. Running in a curvilinear pattern east-west across the plot is a low resistance anomaly (iii), less than a metre wide. This may be a negative cut feature such as a gully. Entering the north-east corner of the plot is a low resistance anomaly (iv) of limited length, possibly a negative cut feature the majority of which lies outside the grid.

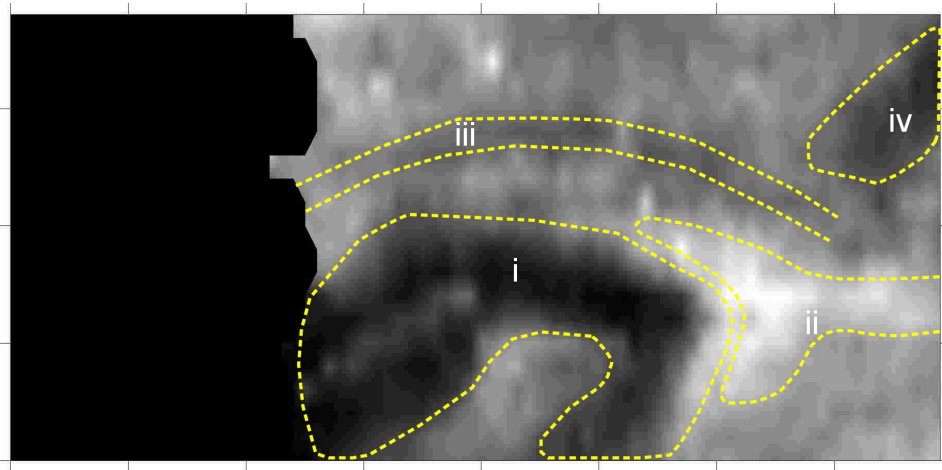

Figure Eight: Interpretation of the resistance survey showing anomalies discussed in the text

3.3.1.3 Figure Nine shows the resistance survey overlaid on the modern location plan. None of the anomalies discussed above appear to represent a continuation of the ditch identified in the excavation trench. Equally, they cannot easily be tied in to current use of the field. Relating the survey to earlier plans provides further clues. Figure Ten shows the resistance survey overlaid on the OS map of 1973. This plan shows a field boundary running across the centre of the survey area. This boundary is also present on maps of

1907 and its former presence corroborated by the farmer, who was responsible for its removal. It may be suggested that anomalies (ii) and (iii) may be related in some way to the former field boundary. Anomaly (i) may be related to former farm structures erected against this field boundary. However the slight spatial mismatch between the mapped features and the resistance survey anomalies may indicate that the former field boundary has not been identified in the survey and that the anomalies represent features from a different period.

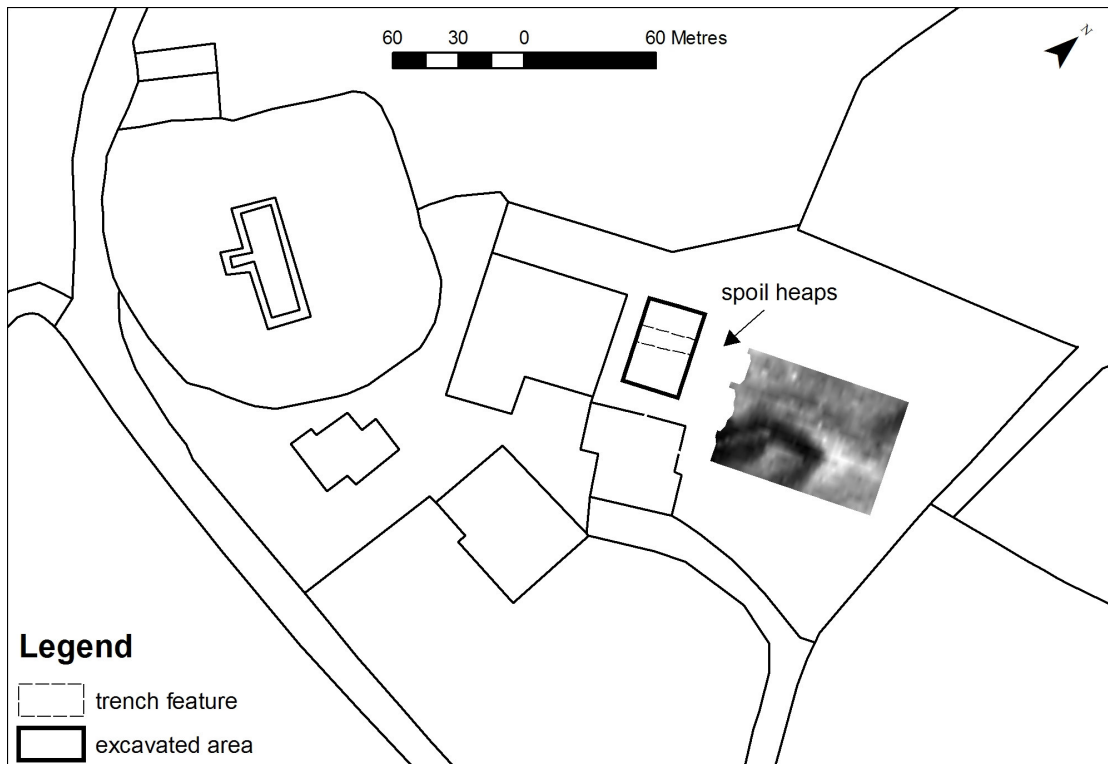

Figure Nine: Resistance survey overlaid on modern map

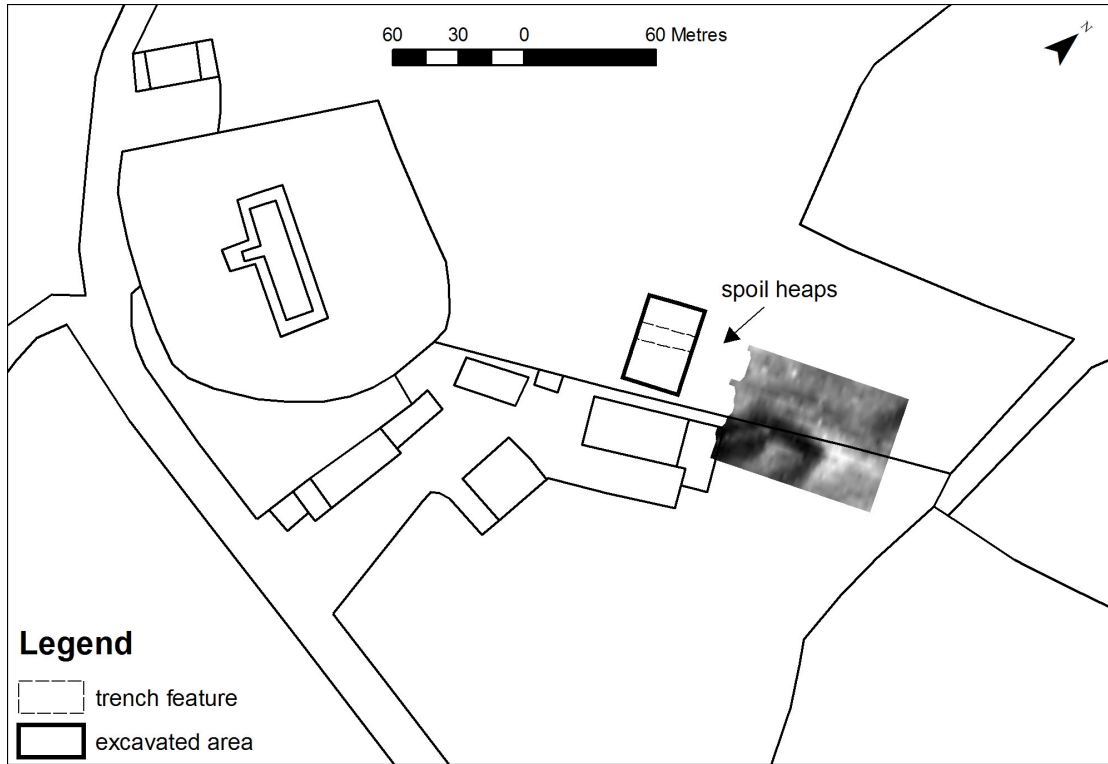

Figure Ten: Resistance survey overlaid on 1973 map

3.3.2 Magnetometry

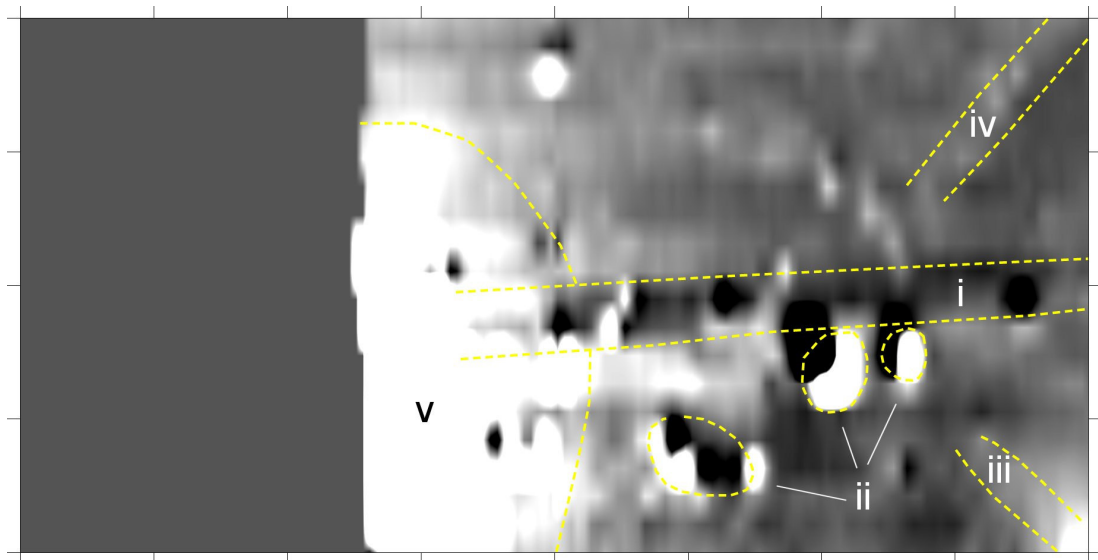

Figure Eleven: Interpretation of the magnetometer survey

3.3.2.1 Figure Eleven shows a graphical summary of the anomalies discussed in the text below.

3.3.2.2 The patterning at (i) is a narrow linear anomaly travelling the full width of the survey area. This possibly represents a gully or drainage pipe trench similar to those witnessed in the excavated trench, however, this interpretation changes somewhat when the survey is overlaid on the location plan (discussed below). Spread throughout the plot are a number of magnetic spikes, three of which have been highlighted (ii). In most cases there are likely to be ferrous rubbish material of the sorts commonly found in the grounds of a farm. Entering diagonally from the south-east corner of the grid is a positive anomaly (iii) which is most likely to be a negative feature such as a ditch, or drainage pipe trench. Anomaly (iv) corresponds with anomaly (iv) in the resistance survey which again may represent a negative cut feature. The strongly positive anomaly occupying much of the western edge of the survey (v) is almost certainly metal fittings of the shed adjacent to the grid edge (see location plan).

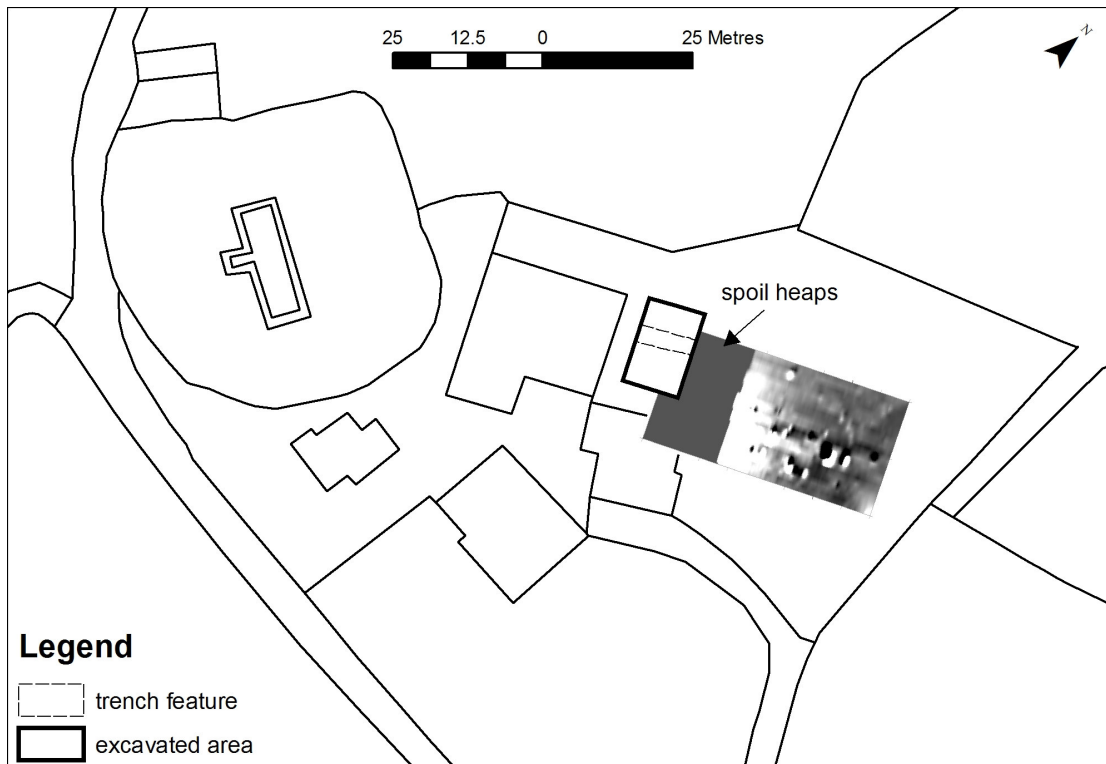

Figure Twelve: Magnetometry survey overlaid on modern map

3.3.2.3 Figure Twelve shows the magnetometry survey overlaid on the modern location plan. None of the features in the plot appear to be an obvious continuation of the ditch witnessed in the excavation trench. Figure Thirteen shows the magnetometry survey overlaid on the 1973 plan. The former field boundary present in this plan aligns well with magnetic anomaly (i), suggesting this anomaly is a bedding trench for a wall or bank for a

hedge line. The magnetic spikes adjacent to this anomaly are potentially debris from a barbed wire fence that perhaps marked this field division.

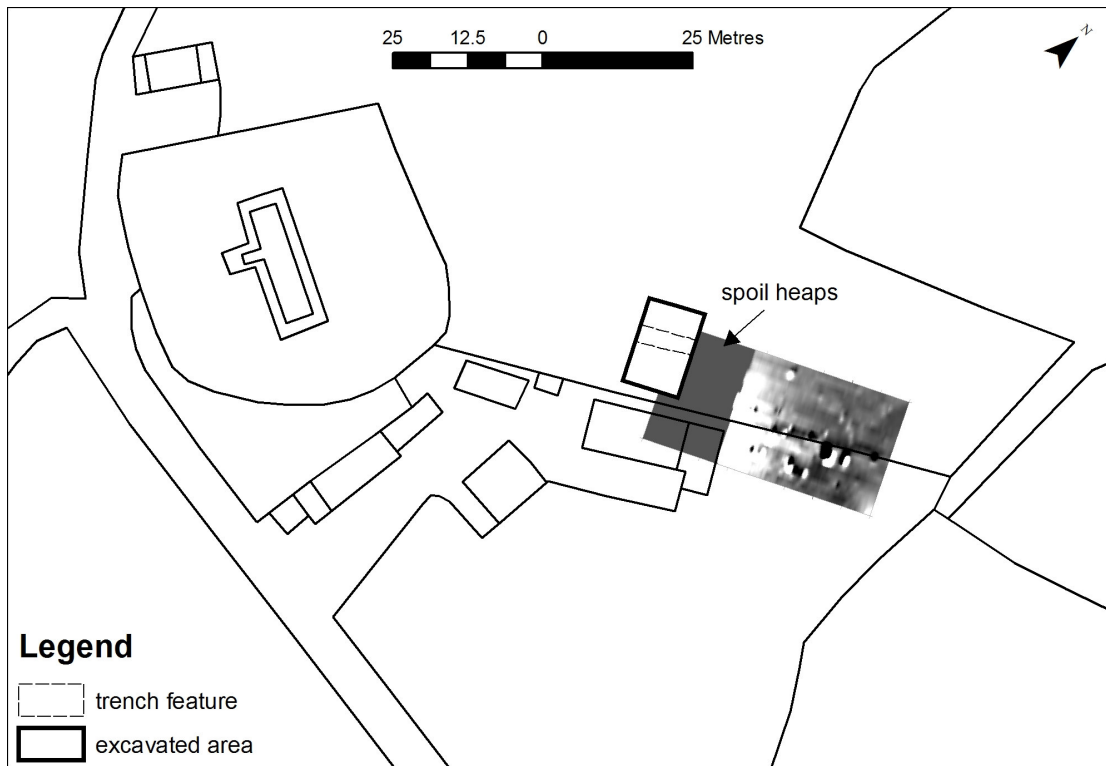

Figure Thirteen: Magnetometry survey overlaid on 1973 map

3.4 Conclusions

3.4.1 Neither the resistivity or magnetometer survey positively identified the continuation of the ditch found in the excavation trench. From this we can conclude that either the ditch terminates shortly beyond the excavated area, or that it changes alignment here, or that, disappointingly, the geophysical techniques have been unsuccessful in picking up the feature. The former field boundary was positively identified with the magnetometry survey, and other anomalies in this and the resistance plot may be related to this boundary. Of particular interest is anomaly (i) in the resistance survey which possibly represents a substantial ditch. However, the area surveyed was small, and all interpretations remain tentative.

4 Excavation

4.1 Methodology

4.1.1 The excavation area consisted of a rectangular trench 10.0m (north-east/south-west) by 15.0m (north-west/south-east). The trench was positioned with its south-western edge running parallel to an adjacent large barn and concrete path. The ground surface was slightly higher in this area, sloping up to the edge of the concrete. The landowner mentioned that during the construction of the barn, and prior to laying down the concrete for the path, he had used rubble as a foundation. The south-eastern limit of excavation was roughly parallel with another outbuilding. The area of excavation was slightly larger than the footprint of the tank to allow for the investigation of the entire foundation of the proposed development. The field is currently used for pasture although it has been ploughed in the past.

4.1.2 During the evaluative part of the exercise excavation was undertaken mechanically down to subsoil level and finds were recorded by context. A number of features were identified cut into subsoil of calp till and these were excavated by hand. The context record for the site was created using the standard context recording method. The list of contexts forms Appendix One, the photographic record is reproduced as Appendix Three and the field drawing register forms Appendix Four. The remainder of the site records consist of a finds register and a sample log (Appendices Five and Six respectively). Numbers used for site records, for example Context Numbers, were continued from the evaluation. The unique site code used to identify the site records during both the evaluation and the excavation was AGH'05. Following the completion of the excavation the area was not backfilled at the request of the landowner.

4.2 Account of the excavations

4.2.1 The Harris matrix for the site is provided in Appendix Two. It is intended that this is referred to whilst reading the following account of the stratigraphic sequence present on the site. The results of both the evaluative exercise and the subsequent excavation have been integrated into the single account which follows.

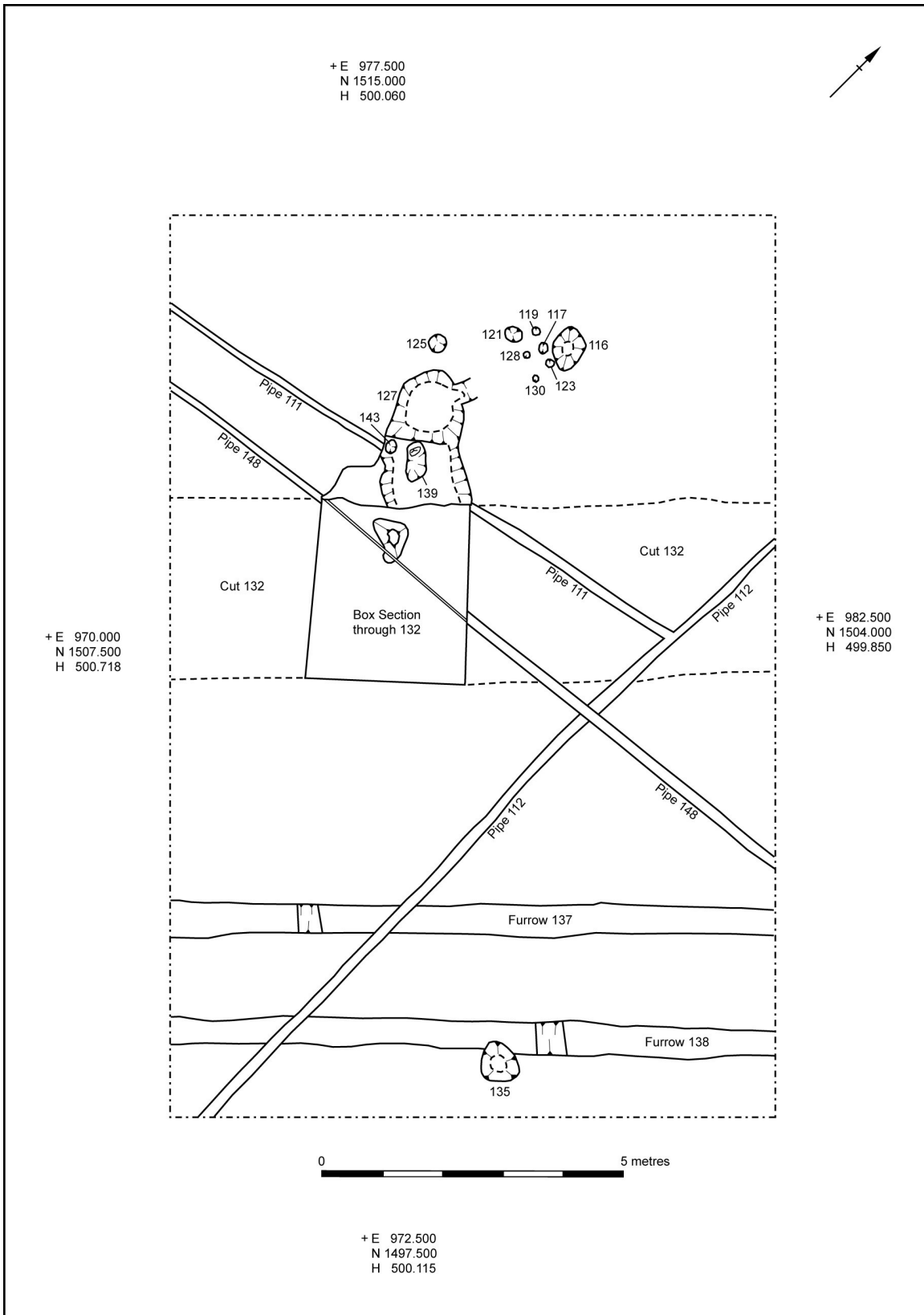

Figure Fourteen: Post-excitation plan of site showing features

4.3 *The evaluation*

4.3.1 The stratigraphically latest deposit was the topsoil (Context No. 101) which was a thin layer of loamy clay. The topsoil (Context No. 101) was 0.05-0.20m deep and contained a number of modern finds including pottery, plastic and corroded iron objects. Below the topsoil along the south-western edge of the trench was a deposit of rubble (Context No. 102) which was the fill of a cut (Context No. 106) likely to have been associated with the construction of the barn and concrete path. The cut was approximately 15.0m long (north-west/south-east), 0.80m wide (north-east/south-west) and up to 0.40m deep. Also below the topsoil were localised patches of a mortar-rich deposit (Context No. 104) which were present in the north-western part of the trench only and were probably deposited as a result of recent building or demolition work. The average size of the mortar-rich patches (Context No. 104) was 1.0-2.0m by 0.5m, and the deposit was in general 0.05m deep. The removal of the topsoil also revealed three modern pipe trenches (Context Nos. 148, 112 and 110) and a cut feature (Context No. 154). The sharp edges of the cut feature (Context No. 154) suggest that it had been mechanically excavated and was probably a relatively modern feature such as a service trench. The cut was approximately 0.20m wide and 0.40m deep and it was filled with light grey clay (Context No. 152). No associated finds were recovered. The latest pipe trench (Context No. 148) ran west/east across the site. It was filled with dark brown silty clay (Context No. 149). The pipe trench (Context No. 148) cut through another pipe trench (Context No. 112) which ran north/south across the site and was filled with dark brown silty clay (Context No. 153). This pipe trench (Context No. 112) cut through a third pipe trench (Context No. 111) which ran parallel to the first (Context No. 148). The third pipe trench (Context No. 111) was also filled with dark brown silty clay (Context No. 110). All three pipe trenches contained plastic water pipes, and no finds were associated.

4.3.2 Stratigraphically below the rubble-filled cut (Context No. 106), the mortar-rich deposit (Context No. 104), the pipe trenches (Context Nos. 148, 112 and 110) and the cut feature (Context No. 154) was a cultivation soil (Context No. 103). The cultivation soil (Context No. 103) was a deposit of greyish brown silty clay which extended over the whole trench. It was up to 0.38m deep and contained a small number of sherds of eighteenth century pottery (Ruairí Ó Baoill *pers. comm.*). Following the mechanical excavation of the cultivation soil (Context No. 103) a number of archaeological features were revealed. These included: a dump of bluish grey clay in the south-western part of the trench (Context No. 105); two plough furrows (Context Nos. 137 and 138); a linear negative feature (Context No. 132); a hearth feature (Context No. 127); two pits (Context Nos. 116

and 135); and seven post- and stake-holes (Context Nos. 117, 119, 121, 123, 125, 128 and 130). The clay dump was removed by mechanical digger during the evaluative exercise. It was found to extend the length of the trench (15.0m north-west/south-east) and was at least 2.10m wide and 0.20-0.40m deep. The clay dump (Context No. 105) had associated with it seventeenth and eighteenth century pottery (Ruairí Ó Baoill *pers. comm.*). The other features were investigated during the subsequent excavation and described below (Paragraphs 4.4 and 4.5).

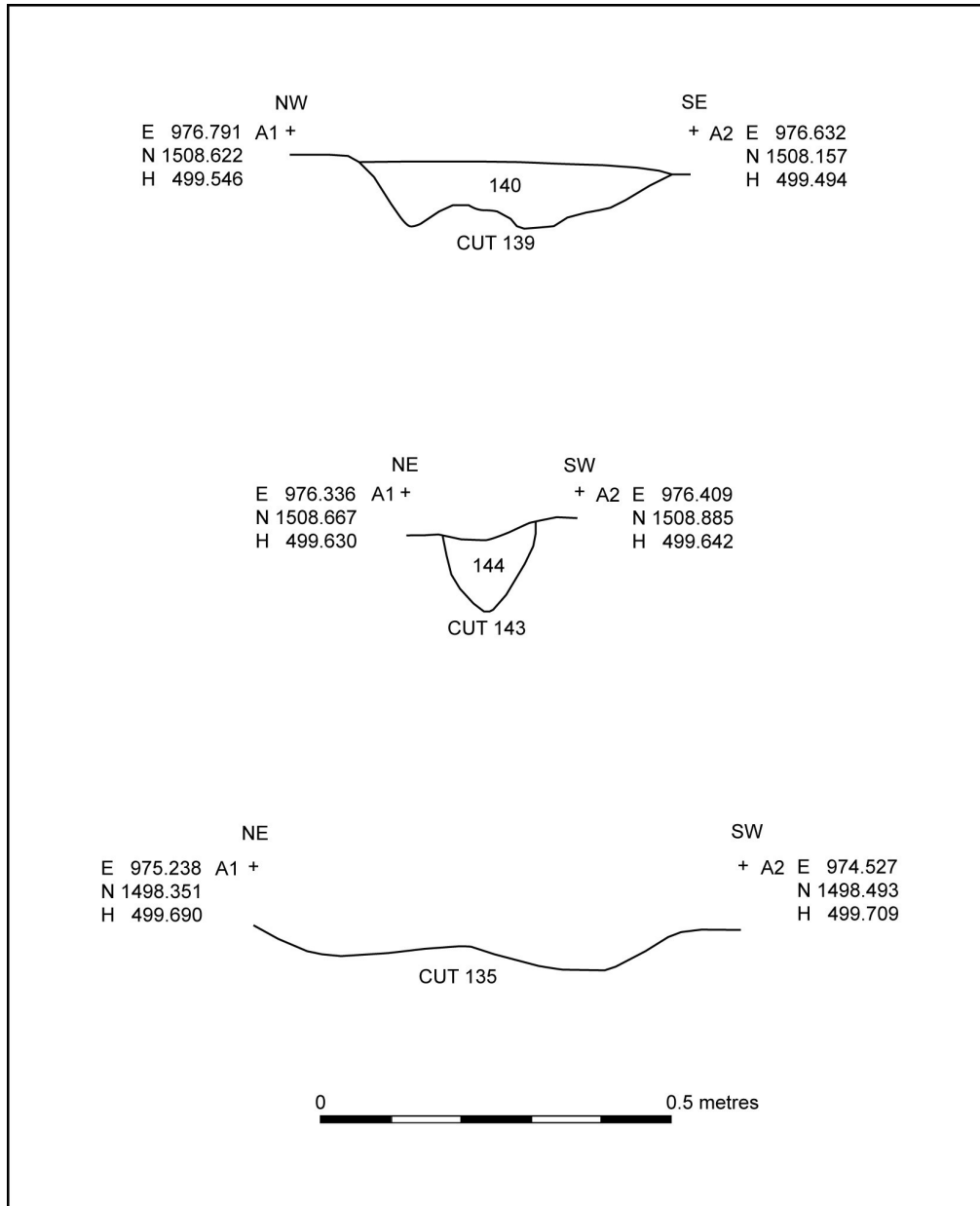

Figure Fifteen: Sections through post-holes (Context Nos. 139 and 144) and profile through pit (Context No. 135)

4.4 *The excavation*

- 4.4.1 As noted above, in Paragraph 4.3.2, the removal of the cultivation soil (Context No. 103) revealed a number of archaeological features and deposits (Figure Fourteen). Beside the south-eastern edge of excavation was a probable pit (Context No. 135) filled with charcoal-rich silty clay (Context No. 136) (Figure Fifteen). The pit was irregular in shape and relatively shallow. It measured 0.62m south/east, 0.30m north-west/south-east and was 0.05-0.06m in depth. Finds included burnt animal bone, lime and ash suggesting that it had possibly been used for the disposal of rubbish.
- 4.4.2 The pit (Context No. 135) cut into the fill (Context No. 114) of a furrow (Context No. 138) which ran parallel with the south-eastern limit of excavation. A second furrow (Context No. 137) ran parallel with the first (Context No. 138). Small exploratory box sections revealed that both furrows were at least 10.0m long (north-east/south-west), 0.80m wide (north-west/south-east) and 0.11m deep. The two furrows (Context Nos. 137 and 138) were both filled with compact greyish brown clay (Context Nos. 113 and 114 respectively) and no finds were associated.
- 4.4.3 In the middle of the trench was a linear feature (Context No. 132), stratigraphically below the clay dump (Context No. 105), which cut an earlier hearth feature (Context No. 127). The linear feature (Context No. 132) was probably the remains of a ditch which may have served as a field boundary (Figures Sixteen and Seventeen). The uppermost fill (Context No. 115) of the ditch (Context No. 132) consisted of mottled greyish orange silty clay containing burnt bone. It was at least 10.0m long (north-east/south-west), approximately 3.0m wide (north-west/south-east) and 0.20-0.60m deep. It was probably intended as a levelling deposit to seal the ditch. Below the uppermost fill (Context No. 115) was a layer of compact grey clay (Context No. 150). This layer was only recognised in the east facing section of the ditch. It was approximately 1.60m wide (north-west/south-east) and approximately 0.30m deep. No finds were associated with the compact grey clay (Context No. 150). The compact grey clay (Context No. 150) lay above a layer of orange mottled silty clay (Context No. 151) which was also recognised in the east facing section of the ditch. The orange mottled silty clay (Context No. 151) was approximately 0.60m wide (north-west/south-east) and 0.20m deep. No artefactual material was associated with this layer. These two fills (Context Nos. 150 and 151) were probably the result of natural silting of the ditch. Below the orange mottled silty clay (Context No. 151) were two slumped deposits (Context No. 109s and 147). These comprised, respectively, of slump from the fill of the hearth feature (see Paragraph 4.3.4, below) and slump of

subsoil on the edge of the ditch. These deposits were present in the north-eastern part of the ditch only. The slump from the hearth feature (Context No. 109s) consisted of dark brown silty clay with frequent charcoal flecks. It was approximately 0.2m wide, at least 1.0m long and 0.2m deep. No finds were associated with this deposit. The lower slumped deposit (Context No. 147) consisted of greyish orange mottled silty clay and had a probable lump of iron tap slag associated with it (Philip Macdonald *pers. comm.*). The lower slumped deposit (Context No. 147) lay above the base of the ditch (Context No. 132). The ditch was linear in plan, approximately 3.5m wide and ran west south-west/ east north-east across the excavated area. The feature was approximately 0.60m deep and had steeply sloping sides and a flattish base.

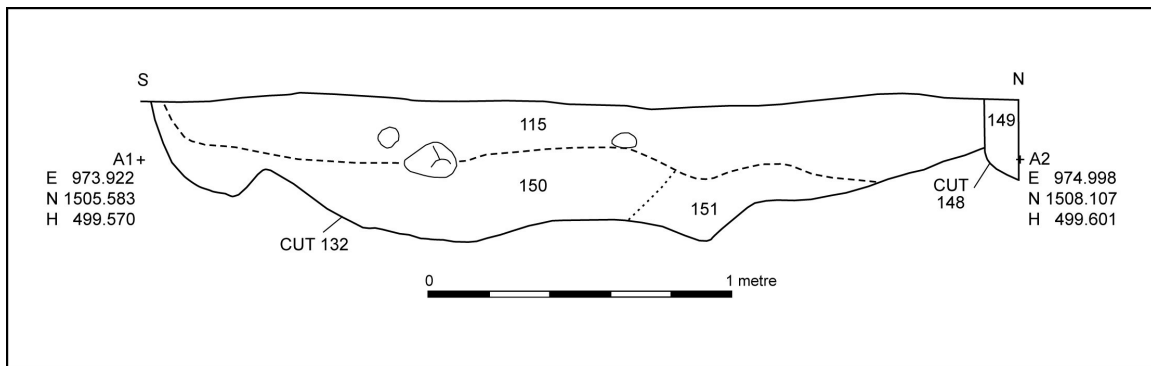

Figure Sixteen: east facing section through ditch (Context No. 132)

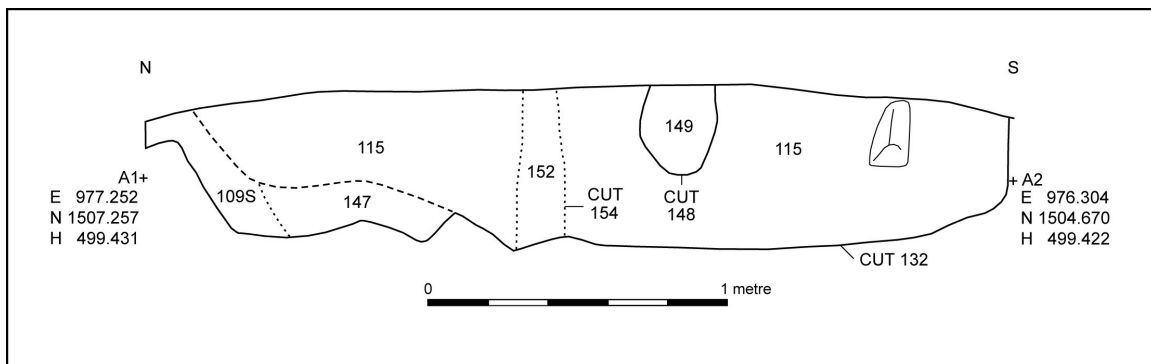

Figure Seventeen: west facing section through ditch (Context No. 132)

4.4.4 The ditch (Context No. 132) cut an earlier feature (Context No. 127) which was a hearth. The hearth feature (Context No. 127) was filled with charcoal-rich silty clay (Context No. 109) and it was this deposit which had slumped into the base of the ditch (Context No. 109s) sometime after the latter was created. The hearth feature (Plate Six) was irregular in plan with steeply sloping sides and a flattish base. It was relatively shallow (0.20m deep) and measured approximately 2.2m (north-west/south-east) by 1.0m north-east/south-west). The hearth fill (Context No. 109) contained a substantial quantity of charred grain, burnt bone and a possible crucible fragment (Philip Macdonald *pers. comm.*). When the hearth fill (Context No. 109) was removed it was found to seal two post-holes (Context Nos. 139 and 143) within the base of the hearth feature (Plate Seven). These may have held posts which formed part of a hearth superstructure. The hearth feature (Context No. 127) was cut into the natural subsoil.

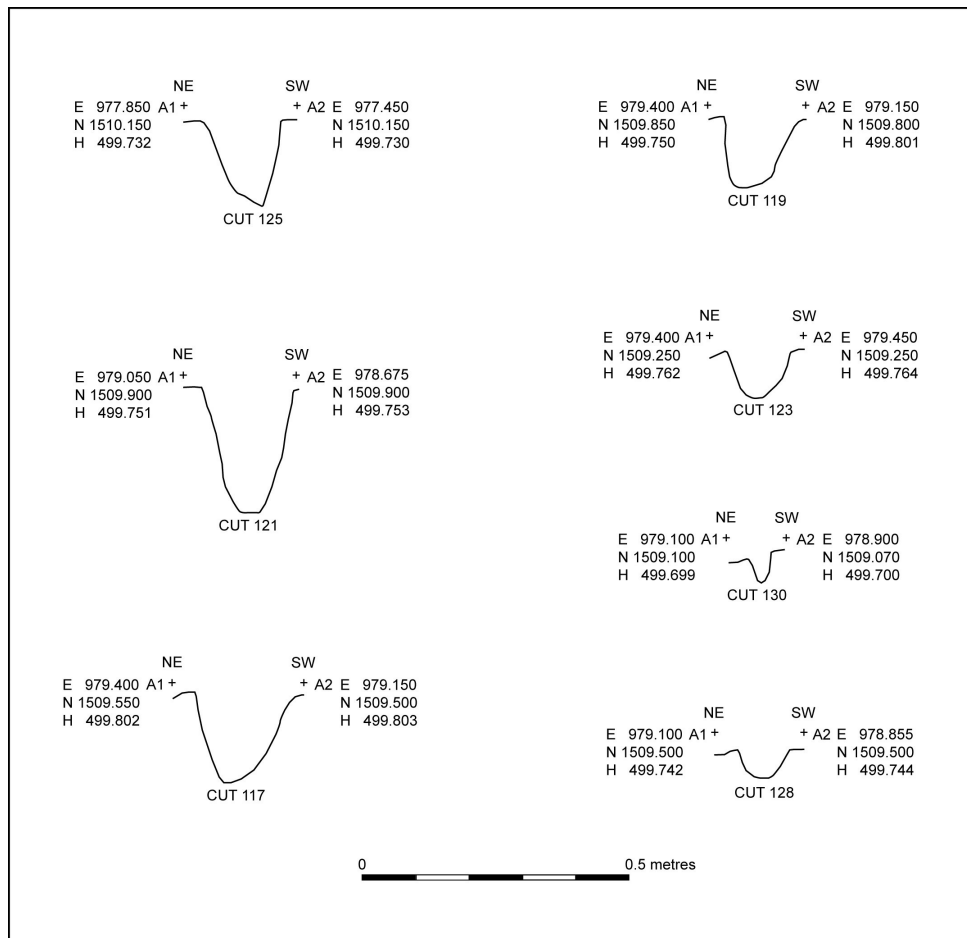

Figure Eighteen: Profiles through post- and stake-holes in northern part of site (Context Nos. 117, 119, 121, 123, 125, 128 and 130)

4.5 *Post-holes, stake-holes and pit*

- 4.5.1 Immediately to the north and north-west of the hearth feature (Context No. 127) was a group of post- and stake-holes (Context Nos. 117, 119, 121, 123, 125, 128 and 130) and a pit (Context No. 116) (Figure Eighteen). Approximately 0.5m north of the hearth feature was a small post-hole (Context No. 125) which may have functioned as part of the hearth superstructure. The post-hole was approximately 0.17m in diameter and 0.17m deep. It was circular in plan with steep sides and a concave base. There was evidence of possible stone packing (Context No. 126) on its north-eastern side. The fill (Context No. 126) of the post-hole (Context No. 125) was dark greyish brown clay with frequent stone inclusions and occasional charcoal flecks.
- 4.5.2 Approximately 1.0m north-east of the small post-hole (Context No. 125) were six further post-/stake-holes and a pit. The post- and stake-holes were aligned in two rows of three (Context Nos. 119, 117, 123 and 121, 128, 130 respectively) but apart from their arrangement no further evidence could be found to suggest that they were part of a single structure. Immediately to the north-east of the small post-hole (Context No. 125) was another small post-hole (Context No. 121). It was approximately 0.1m in diameter and 0.12m deep. The post-hole was circular in plan with steeply sloping sides which tapered to a pointed base. It was filled with dark bluish grey clay (Context No. 122) which contained charcoal flecks and small stones. The second feature, a small post-hole or a stake-hole (Context No. 119), was located 0.25m to the north-east of the small post-hole (Context No. 121). It was 0.15m in diameter and 0.15m deep, sub-circular in plan with straight sides that tapered to a pointed base. The feature (Context No. 119) was filled with dark grey clay (Context No. 120), which contained flecks of charcoal and small stones. Approximately 0.2m to the east of the small post-hole (Context No. 119) was a stake-hole (Context No. 117) which was filled with dark grey clay (Context No. 118). The stake-hole (Context No. 117) was 0.11m in diameter and 0.14m deep. It was circular in plan with steep sides and a concave base. Approximately 0.2m to the south-east of the stake-hole (Context No. 117) was a small post-hole or stake-hole (Context No. 123) which was 0.16m in diameter and 0.21m deep. It was circular in plan with steep sides which tapered to its base. This feature (Context No. 123) was filled with dark bluish grey clay (Context No. 124) which was compact and contained flecks of charcoal and small stones. The fifth stake-hole (Context No. 130) was located approximately 0.3m to the south of the small post-hole (Context No. 123). It was a small feature, being 0.06m in diameter and 0.06m deep. The stake-hole (Context No. 130) was sub-circular in plan with steeply sloping sides and a concave base. It was filled with greyish orange clay

- (Context No. 131) which contained charcoal flecks. Approximately 0.4m to the north-west of the fifth stake-hole (Context No. 130) was the final feature in the group (Context No. 128). This feature too was a stake-hole, 0.08m diameter and 0.07m deep. It was circular in plan with steeply sloping sides and a concave base. It was filled with greyish orange mottled clay (Context No. 129) which contained charcoal flecks. Preliminary post-excavation sieving of samples derived from these features has shown that some of the post- and stake-holes contained small amounts of charred grain.
- 4.5.3 Directly beside the group of post- and stake-holes was a pit (Context No. 116). The pit was circular in plan with steep sides and a concave base. It was between 0.52-0.59m in diameter and 0.21m deep. It was filled with a charcoal-rich fill of dark grey clay with frequent stone inclusions (Context No. 108). Preliminary post-excavation sieving work has demonstrated that the pit contained charred grain, burnt animal bone, oyster shell and slag (John Davison *pers. comm.*).
- 4.6 *Phasing of the stratigraphic sequences present*
- 4.6.1 The stratigraphic sequences excavated at Aghaloo can be divided into five main phases of activity. These have been included on the Harris Matrix which is provided in Appendix Two. The earliest phase (Phase I) was represented by the hearth feature (Context No. 127). It is possible that the post-/stake-holes (Context Nos. 117, 119, 121, 123, 125, 128 and 130) and pit (Context No. 116) in the area to the north and north-west of the hearth feature (Context No. 127) were contemporary with it, but as there is no evidence to this end these features have been left unphased.
- 4.6.2 During the second phase of activity on the site (Phase II), the ditch (Context No. 132) was cut which resulted in the slumping of the fill (Context No. 109) of the hearth feature (Context No. 127). There was also partial slumping of the edge of the ditch (allocated Context No. 147).
- 4.6.3 The third phase (Phase III) consisted of the in-filling of the ditch (Context No. 132). The two lower layers (Context Nos. 150 and 151) were probably the result of natural silting of the ditch. The uppermost fill (Context No. 115) was probably added deliberately as a levelling deposit to seal the ditch.
- 4.6.4 The penultimate phase of activity at Aghaloo (Phase IV) was the result of agricultural activity. During the fourth phase the two plough furrows (Context Nos. 137 and 138), the

irregular pit (Context No. 135) and the dump (Context No. 105) were created, all of which were overlain by a cultivation soil (Context No. 103).

- 4.6.5 The final phase of activity (Phase V) consisted of the modern pipe trenches (Context Nos. 111, 112 and 148), the rubble-filled cut (Context No. 106), the mortar-rich layer (Context No. 104) and the cut feature (Context No. 154), overlying all of which was the topsoil (Context No. 101).

5 Discussion

- 5.1 The excavation at Aghaloo Church confirmed the existence of a ditch (Context No. 132). The feature was linear with steeply sloping sides and a slightly concave base. The homogeneity of the uppermost fill (Context No. 115) of the ditch suggested that it had not accumulated gradually and was more likely to have been intended as a sealing or levelling deposit. Various other fills (Context Nos. 150 and 151) were probably due to slight silting of the base of the feature and slumping of earlier deposits disturbed by the cutting of the ditch. No immediately datable material was recovered from the ditch (Context No. 132) and although animal bone was present within the uppermost fill (Context No. 115) a date of this material is likely to be late and would date the levelling of the feature rather than its construction. The absence of artefactual material from the ditch (Context No. 132) suggests that it was not the focus of intense activity and probably not of great importance. The ditch (Context No. 132) was probably a field boundary and may originally have consisted of a bank and ditch. While the bank has been ploughed out only the base of the ditch remains.
- 5.2 The limited geophysical survey carried out during the course of the excavation revealed interesting results. None of the anomalies represented a satisfactory candidate for the continuation of the excavated ditch. Four anomalies were identified from the resistivity survey. Two of the anomalies (Anomalies (i) and (ii)) comprised what resembled a bank and ditch feature, however, these anomalies did not line up satisfactorily with the excavated feature in the trench. Anomaly (iii) was a curvilinear feature less than a metre wide which may have been a gully. The final anomaly (Anomaly (iv)) consisted of a negative feature approximately 5.0m long and some 3.0-4.0m wide which was possibly a cut feature such as a ditch but the survey did not extend far enough to fully investigate it. Anomaly (iv) was set at right angles to the excavated ditch feature. Five anomalies were identified from the magnetometer survey. Anomaly (i) was a linear anomaly approximately 20.0m in length and 1.0m wide which ran east-west across the survey grid. It probably represented a gully or a drainage pipe trench similar to the pipe trenches excavated in the trench (Context Nos. 110, 112 and 148). When the survey was overlaid on the 1973 Ordnance Survey map this anomaly corresponded with a no longer extant field boundary. A number of magnetic spikes (all labelled as Anomaly (ii)) spread throughout the survey area were likely to have been the result of modern ferrous rubbish. A third anomaly (Anomaly (iii)) was probably a negative feature such as a ditch, or drainage pipe trench. A strongly positive anomaly in the western part of the grid

- (Anomaly (v)) was probably caused by the metal fittings of the shed adjacent to the edge of the grid.
- 5.3 The features uncovered during the evaluation were further investigated. The hearth feature (Context No. 127) and post-/stake-hole group to the north (Context Nos. 117, 119, 121, 123, 125, 128 and 130) were possibly contemporary, although this is not demonstrable. The intended function of the pit (Context No. 116) is unclear although it was probably re-used for rubbish. The close proximity to the hearth of the group of post- and stake-holes (Context Nos. 117, 119, 121, 123, 125, 128 and 130) may have formed part of a superstructure for the hearth (Context No. 127); perhaps in the form of a windbreak to protect it from the wind. The exact nature of the hearth feature (Context No. 127) is unclear as there was little evidence of *in situ* burning in the form of scorched earth. The presence of an extremely charcoal-rich fill within the two post-holes (Context Nos. 139 and 143) sealed by the fill of the hearth (Context No. 109) suggests that the posts may have been burnt *in situ*. The post-holes (Context Nos. 139 and 143) were obscured by a layer of charcoal-rich silty clay (Context No. 109) which may have been derived from burning elsewhere and dumped into the hearth feature when it had gone into disuse. This layer (Context No. 109) contained a substantial amount of charred grain. Preliminary analysis of this material has indicated that it includes oats, wheat, barley and hazelnut shell, the condition of which suggests the assemblage is of some antiquity (Gill Plunkett *pers. comm.*). The fill (Context No. 109) of the hearth feature (Context No. 127) also contained a possible crucible fragment, and this, coupled with small amounts of slag found elsewhere (Context Nos. 108 and 147) suggests that metalworking was taking place on or in the vicinity of the site. Preliminary analysis of the slag suggests the use of early metalworking technology (Philip Macdonald *pers. comm.*).
- 5.4 Although the exact nature and date of the archaeological features present at Aghaloo Church are not fully understood, the investigation at the site revealed a concentration of activity in the area to the north-east of the church. In the absence of absolute dates it is not possible to say if this activity was contemporary with, later than or earlier than the church.

6 Recommendations for further work

6.1 Introduction

6.1.1 There are several areas of further work required to bring the Aghaloo excavation report to final publication. The proposed publication would comprise a short note intended for submission to the *Ulster Journal of Archaeology* combining the history of the site, the excavation results and an evaluation of the results of the geophysical survey. It is intended that a summary is also published in the *Excavations 2005* bulletin. The areas requiring further attention are detailed below in Sections 6.2-6.6.

6.2 Processing of soil samples

6.2 Thirteen soil samples in total have already been processed by work experience students under the supervision of John Davison. This work was undertaken free of charge. To provide a fully representative sample of material for specialist analysis it will be necessary to process the remaining soil samples. There are thirteen soil samples requiring further work. It is recommended that this work is carried out by Centre for Archaeological Fieldwork auxiliary crew.

6.3 Programme of radiocarbon dating

6.3.1 The material suggested for radiocarbon dating is outlined in Table Two, below. It is proposed that two radiocarbon dates are obtained. The material for dating would preferably be derived from the fill (Context No. 108) of the pit (Context No. 116) and the fill (Context No. 109) of the hearth feature (Context No. 127). The pit (Context No. 116) is one of a group of negative features (Context Nos. 117, 119, 121, 123, 125, 128 and 130) which, although contemporary with each other, have no meaningful stratigraphical relationship with the other cut features in the excavation area. The fill (Context No. 108) of this pit (Context No. 116) contained evidence of metalworking along with burnt bone and shell. It is hoped that an absolute date from this feature may suggest the nature of its temporal relationship with the hearth and ditch features (Context Nos. 127 and 132). It is recommended that the second radiocarbon date is obtained from the fill (Context No. 109) of the hearth feature (Context No. 127). An absolute date from this deposit (Context No. 109) should provide a *terminus post quem* for the construction of the ditch and therefore consolidate the chronological sequence present on the site.

Context No.	Material
108	Bone
109	Charcoal

Table Two: suggested material for radiocarbon dating

6.4 *Slag*

6.4.1 It is recommended that an evaluative report on the slag is undertaken in order to assess its potential for further analytical study. Initial analysis of the material suggests the exploitation of several different types of metal; there is both a possible crucible fragment and iron tap slag (Philip Macdonald *pers. comm.*). Initial indications are that the metalworking technology in use was early and it is hoped that further study of the material, combined with absolute dates, will help put this knowledge into context. It is recommended that the material is sent to Tim Young of GeoArch Consultancy who has extensive experience in dealing with material of this type.

6.5 *Macrofossil analysis*

6.5.1 Preliminary analysis of the charred grain recovered from some of the features at Aghaloo has confirmed the presence of wheat, barley and oats (Gill Plunkett *pers. comm.*). The condition of the macrofossil material strongly suggests that it is of some antiquity. Study of the macrofossil remains, combined with absolute dates, would provide further information on the activities being carried out on or in the vicinity of the site. It is recommended that this material is studied by Gill Plunkett of Queen's University Belfast.

6.6 *Animal bone*

6.6.1 It is recommended that the small amount of animal bone recovered during the course of the excavation is studied. It is hoped that analysis of the bone would give further insight into what the site was being used for; for example, what sort of animals were present and were these being deliberately butchered and utilised. This analysis may also help identify suitable material for radiocarbon dating from the hearth (Context No. 127) and the pit (Context No. 116). It is recommended that the animal bone is studied by Emily Murray of Queen's University Belfast.

Bibliography

- Bartlett, Richard. 1609. *Maps of the Escheated Counties of Ireland* (copied at the Ordnance Survey Office in Southampton by Colonel Sir Henry James in 1861). Southampton
- Davies, O. 1941. 'Carnteel Church', *Ulster Journal of Archaeology* 4, 149-150.
- Dillon, C. and Jefferies, H.A. (eds.) *Tyrone: history and society*. Dublin.
- Hamlin, A. 1976. *The Archaeology of Early Christianity in the North of Ireland*. (Unpublished Ph. D thesis, three volumes). Queen's University Belfast.
- Leslie, J.B. 1911. *Armagh Clergy and Parishes*. Dundalk.
- Lewis, S. 1837. *A Topographical Dictionary of Ireland*. London.
- Marshall, J.J. 1925. *Annals of Aghnacloy and the Parish of Carnteel, County Tyrone*. Dungannon.
- McAleer, P. 1925. *Townland Names of County Tyrone: With Their Meanings*. Portadown.
- Mitchell, W.I. (ed.). 2004. *The Geology of Northern Ireland: Our Natural Foundation*. Geological Survey of Northern Ireland. Belfast.

Appendix One: Context List

<i>Context</i>	<i>Description</i>
<i>No.</i>	
101	Topsoil/sod layer
102	Rubble fill of cut (Context No. 106)
103	Cultivation deposit
104	Creamy mortar lenses
105	Grey clay dump
106	Cut associated with rubble (Context No. 102)
107	N/A
108	Fill of pit (Context No. 116)
109	Fill of hearth feature (Context No. 127)
109s	Slumped fill of hearth feature (Context No. 127)
110	Cut of pipe trench running E-W across trench
111	Fill of pipe trench (Context No. 110)
112	Cut of pipe trench running N-S across trench
113	Fill of furrow (Context No. 137)
114	Fill of furrow (Context No. 138)
115	Fill of ditch (Context No. 132)
116	Cut of pit in north-eastern area of trench
117	Cut of stake-hole beside pit (Context No. 116)
118	Fill of stake-hole (Context No. 117)
119	Cut of small post-hole beside pit (Context No. 116)
120	Fill of small post-hole (Context No. 119)
121	Cut of stake-hole to south-west of pit (Context No. 116)
122	Fill of stake-hole (Context No. 121)
123	Cut of small post-hole beside pit (Context No. 116)
124	Fill of small post-hole (Context No. 123)
125	Cut of small post-hole to north-west of hearth feature (Context No. 127)
126	Fill of small post-hole (Context No. 125)
127	Cut of hearth feature in north-western area of trench
128	Cut of stake-hole to west of stake-hole (Context No.117)
129	Fill of stake-hole (Context No.128)
130	Cut of stake-hole to south of small post-hole (Context No. 123)
131	Fill of stake-hole (Context No.130)
132	Cut of linear feature / ditch running WSW-ENE across trench
133	N/A

Context No.	Description
134	N/A
135	Cut of pit beside south-eastern baulk
136	Fill of pit (Context No.135)
137	Cut of furrow beside south-eastern baulk
138	Cut of furrow to north-west of furrow (Context No. 137)
139	Cut of post-hole within hearth feature (Context No. 127)
140	Fill of post-hole (Context No. 139)
141	N/A
142	N/A
143	Cut of small post-hole within hearth feature (Context No. 127)
144	Fill of small post-hole (Context No. 143)
145	N/A
146	Trample in south-eastern area of trench
147	Deposit of slump on north-western edge of ditch (Context No. 132)
148	Cut of pipe trench running E-W across trench
149	Fill of pipe trench (Context No. 148)
150	Grey clay fill of ditch (Context No. 132)
151	Mottled clay fill of ditch (Context No. 132)
152	Grey clay fill of possible post-hole (Context No. 154)
153	Fill of pipe trench (Context No. 112)
154	Cut of possible post-hole visible in west facing section of ditch

Appendix Two: Harris Matrix

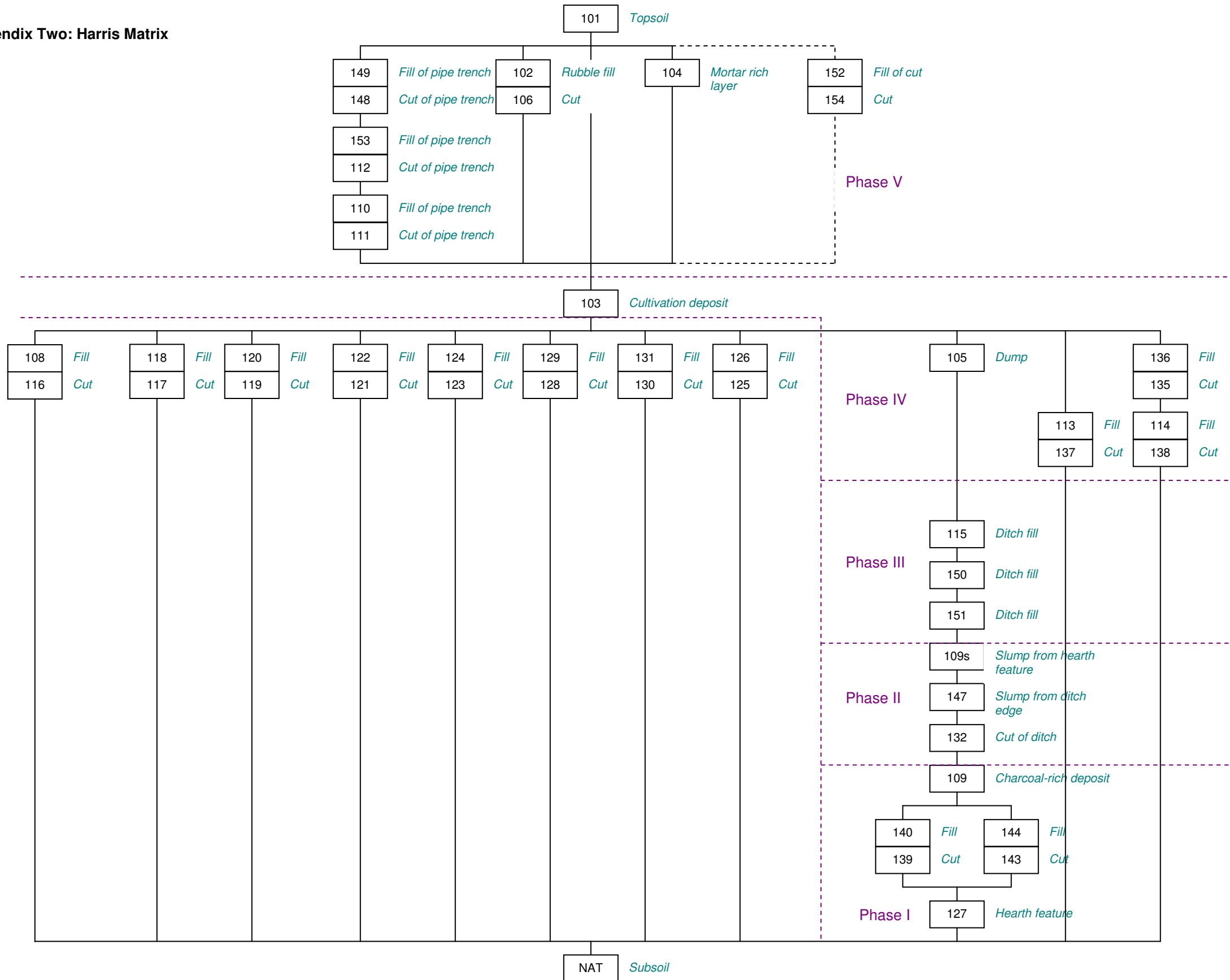

Appendix Three: Photographic Record

Digital Photographs

Nikon Coolpix 5000 Digital Camera

19th September 2005

- 1 General view prior to excavation (looking south-east)
- 2 General view prior to excavation (looking north-east)
- 3 General view prior to excavation (looking north)
- 4 General view prior to excavation (looking south-west)
- 5 Work in progress (looking east)
- 6 Southern corner of trench showing rubble (Context No.102) and cultivation deposit (Context No. 103) (looking south)
- 7 General view of trench following removal of topsoil (Context No. 101) by mechanical digger (looking south-east)

20th September 2005

- 8 Pit (Context No. 108) prior to excavation (looking east)
- 9 Pit (Context No. 108) prior to excavation (looking west)
- 10 VOID
- 11 Hearth feature (Context No. 127) prior to excavation (looking east)
- 12 Hearth feature (Context No. 127) prior to excavation (looking east)

21st September 2005

- 13 Pit (Context No.116) following removal of half of fill (Context No. 108) (looking south-east with flash)
- 14 Pit (Context No.116) following removal of half of fill (Context No. 108) (looking south-east with flash)
- 15 Pit (Context No.116) following removal of half of fill (Context No. 108) (looking south-east, without flash)
- 16 Section through furrow (Context No. 138) (looking south-east)
- 17 Section through furrow (Context No. 137) (looking south-east, with flash)
- 18 Section through furrow (Context No. 137) (looking south-east, without flash)

- 19 Ditch (Context No.132) and possible gully (Context No. 133) (looking south-west)
- 20 Ditch (Context No.132) and possible gully (Context No. 133) (looking south-west)
- 21 Ditch (Context No.132) (looking south-west)
- 22 Northern end of trench showing pit (Context No.116), post- and stake-holes and section through ditch (Context No.132) (looking south-east)
- 23 Section through ditch (Context No.132) (looking west)
- 24 Close-up of ditch (Context No.132) (looking north-west)
- 25 Close-up of possible gully (Context No. 133) (looking south-west)
- 26 Section through ditch (Context No.132) (looking north-east)
- 27 Interior of church (looking east)
- 28 Eastern gable of church (looking west)

19th October 2005

- 29 General view of section through ditch (looking north-east)
- 30 General view of northern corner of trench (flooded area) (looking north-east)

20th October 2005

- 31 Pit (Context No.116) following removal of fill (Context No. 108) (looking south-east)
- 32 Pit (Context No.116) following removal of fill (Context No. 108) (looking north-west)
- 33 General view of church (looking north)
- 34 Pre-ex shot of hearth feature (Context No.127) (looking south-east)
- 35 Pre-ex shot of hearth feature (Context No.127) (looking south-east)

21st October 2005

- 36 View of section of hearth feature (Context No. 127) (looking south-west)
- 37 View of section of hearth feature (Context No. 127) (looking south-west)
- 38 Hearth feature (Context No. 127) (looking south-east)

24th October 2005

- 39 General shot of flooded area (looking north-east)

27th October 2005

- 40 Record shot of ditch edge (Context No.132), fill of hearth feature (Context No. 109) and possible gully (Context No. 133) (looking south-west)
- 41 North-east facing section of hearth feature (Context No. 127/109) (looking south-west)
- 42 Hearth feature (Context No. 127) following removal of half of fill (Context No. 109) (looking north-east)
- 43 Hearth feature (Context No. 127) following removal of half of fill (Context No. 109) (looking north-east)

28th October 2005

- 44 Hearth feature (Context No. 127) showing probable features (looking south-west)
- 45 Close-up of probable posthole (Context No. 139) (looking south-west)
- 46 General shot of hearth feature (Context No. 127) also showing probable posthole (Context No. 127) (looking north-east)

31st October 2005

- 47 North-east facing section of ditch (Context No. 132) (looking south-west)
- 48 North-east facing section of ditch (Context No. 132) (looking south-west)
- 49 South-west facing section of ditch (Context No.132) (looking north-east)
- 50 South-west facing section of ditch (Context No. 132) (looking north-east)
- 51 South-west facing section of post-hole (Context No. 139) following removal of half of fill (Context No. 140) (looking north-east)
- 52 Record shot of northern edge of ditch (Context No. 132) with fill in situ (looking north-east)
- 53 North-east facing section of post-hole (Context No.143) following removal of half of fill (Context No. 144) (looking south-west)
- 54 Record shot of north-western edge of ditch (Context No. 132) (looking south-west)

1st November 2005

- 55 Possible gully (Context No. 133) following excavation (looking north-east)
- 56 Possible gully (Context No. 133) following excavation (looking north-east)
- 57 Pit (Context No. 135) at beside south-eastern limit of excavation (looking south-east)
- 58 North-east facing section of ditch (Context No. 132) (looking west)
- 59 South-east facing section of ditch (looking north-west)
- 60 Post-ex shot of post-hole (Context No. 139) (looking south-west)

- 61 Post-ex shot of post-hole (Context No. 143) (looking south-west)
- 62 Post-ex shot of hearth feature (Context No. 127) (looking north-west)
- 63 Close-up of south-east facing section of ditch (looking north-west)
- 64 South-east facing section of ditch (looking north-west)

2nd November 2005

- 65 South-west facing section of ditch (looking north-east)
- 66 North-east facing section of ditch (looking south-west)

3rd November 2005

- 67 Possible field boundary to east of excavation area (looking east)
- 68 Record shot showing projected line of ditch (looking south-west)
- 69 Record shot showing projected line of ditch to field boundary (looking east)
- 70 Record shot showing projected line of ditch to field boundary (looking east)

Appendix Four: Field Drawing Register

<i>Drawing No.</i>	<i>Scale</i>	<i>Type</i>	<i>Description</i>
1	1:20	Section	South-east facing section of trench showing Context Nos. 101, 102, 103, 104, 105 and 106
2	1:50	Plan	Pre-excavation plan of trench showing locations of potential features
3	1:10	Section	North-west facing section through pit (Context No. 116) showing fill (Context No. 108)
4	1:20	Section	North-east facing section of box section through ditch (Context No. 132) and associated features
5	1:50	Plan	Post-excavation plan of trench showing excavated/partially excavated features and projected line of ditch
6	1:10	Profile	Profile through post-hole (Context No. 125) following removal of fill (Context No. 126)
7	1:10	Profile	Profile through stake-hole (Context No. 121) following removal of fill (Context No. 122)
8	1:10	Profile	Profile through post-hole (Context No. 119) following removal of fill (Context No. 120)
9	1:10	Profile	Profile through stake-hole (Context No. 117) following removal of fill (Context No. 118)
10	1:10	Profile	Profile through post-hole (Context No. 123) following removal of fill (Context No. 124)
11	1:10	Profile	Profile through stake-hole (Context No. 130) following removal of fill (Context No. 131)
12	1:10	Profile	Profile through stake-hole (Context No. 128) following removal of fill (Context No. 129)
13	1:10	Section	Section through hearth feature (Context No. 127) following removal of half of fill (Context No. 109)
14	1:20	Plan	Pre-ex plan of potential features within hearth feature (Context No. 127) following removal of fill (Context No. 109)
15	1:10	Section	Section through post-hole (Context No. 139) following removal of half of fill (Context No. 140)
16	1:10	Section	Section through post-hole (Context No. 143) following

			removal of half of fill (Context No. 144)
17	1:10	Profile	Profile through possible pit (Context No. 135) following removal of fill 135
18	1:20	Plan	Post-ex plan showing (Context Nos. 127, 139 and 144)
19	1:10	Section	East facing section of ditch (Context No. 132)
20	1:10	Section	West facing section of ditch (Context No. 132)
21	1:50	Plan	Post-excavation plan of trench showing excavated features
22	1:200	Plan	Survey plan of excavation area, showing trench, field boundaries etc.
23	1:100	Plan	Survey plan of graveyard showing distribution of burials

Appendix Five: Finds Register

Context No.	Type	Quantity (No. of pieces)	Comment/ description
101	Ceramics	6	
101	Plastic	1	Drain pipe
101	Iron	2	Horse shoe and bolt
103	Ceramics	2	
105	Ceramics	10	
105	Flint	1	Possibly struck
109	Animal tooth	2	
109	Flint	2	
109	Flint	2	Natural glacially derived
109	?Burnt bone	3	
109	?Burnt bone	6	
115	?Lignite	1	Small Find 1001
115	Animal bone	12	
115	Quartz	1	Possibly struck
115	Animal bone	4	
115	Animal bone	4	
115	Animal bone	2	
115	Animal bone	10	
146	Animal bone	4	
146	Stone	1	
147	Diatomite/fossilized coral?	1	Fossil

Appendix Six: Sample Register

<i>Sample No.</i>	<i>Context No.</i>	<i>No. of bags</i>	<i>Purpose</i>
1	108	1	Radiocarbon dating
2	118	1	Radiocarbon dating
3	120	1	Radiocarbon dating
4	122	1	Radiocarbon dating
5	124	1	Radiocarbon dating
6	126	1	Radiocarbon dating
7	109	1	Radiocarbon dating
8	109	1	Radiocarbon dating
9	VOID	VOID	VOID
10	129	1	Radiocarbon dating
11	131	1	Radiocarbon dating
12	147	1	Radiocarbon dating
13	136	1	Recovery and identification of animal bone
14	136	1	Recovery and identification of animal bone
15	115	1	Radiocarbon dating
16	109	1	Radiocarbon dating
17	140	1	Radiocarbon dating
18	144	1	Radiocarbon dating
19	134	1	Radiocarbon dating
20	134	1	Radiocarbon dating
21	136	1	Recovery and identification of animal bones
22	147	1	Radiocarbon dating
23	109	5	Radiocarbon dating

Appendix Seven: Soil residue report (John Davison)

Sample No.	Context No.	Soil Weight (kg)	Charcoal Weight (g)	Charcoal Content	Contents of Final Residue
1	108	4.55	43.7	69 charred grain	Burnt bone, shell, metal
2	118	0.92	0.1	Negative	Negative
3	120	1.16	3.0	4 charred grain	Negative
4	122	0.51	0.9	5 charred grain	Negative
5	124	1.25	3.8	3 charred grain	Negative
6	126	3.00	8.9	6 charred grain	Burnt bone, shell
7	109	4.19	180.2	380 charred grain Hazelnut shell	Burnt bone, animal teeth
8	109	4.08	36.6	220 charred grain	Burnt bone, flint
10	129	0.28	0.1	Negative	Negative
11	131	0.19	0.8	3 charred grain	Negative
12	134	4.06	44.7	96 charred grain	Burnt bone, shell
13	136	2.88	Negative	Negative	Animal bone, shell
14	136	3.84	Negative	Negative	Animal bone, shell



Plate One: Apex of eastern gable of church (looking east)



Plate Two: Relict window tracery exterior of eastern gable of church (looking west)



Plate Three: Probable graveyard soil banked up against gateposts in graveyard (looking north-west)



Plate Four: Bank material in north-western area of graveyard (looking west)



Plate Five: Mortared stones in wall of graveyard boundary (looking north)



*Plate Six: Hearth feature (Context No. 127) following removal of half of fill (Context No. 109)
(looking south-east)*



Plate Seven: Post-hole (Context No. 139) within hearth feature (Context No. 127), prior to excavation (looking south-west)