

Centre for Archaeological Fieldwork
School of Geography, Archaeology and Palaeoecology
Queen's University Belfast



Data Structure Report No. 050

Excavations at Rossmacaffry, Lisnaskea, Co. Fermanagh

AE/07/78

On behalf of

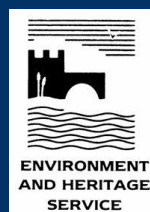



**Excavations at Rossmacaffry
Lisnaskea
Co Fermanagh**

Brian Sloan

CAF DSR 050

Licence No: AE/07/78

Contents

Summary	Page 1
Introduction	Page 4
Account of the excavation	Page 11
Discussion	Page 19
Recommendations for further work	Page 23
Bibliography	Page 25
Appendix One: Context Register	Page 26
Appendix Two: Harris Matrix	Page 27
Appendix Three: Photographic Register	Page 28
Appendix Four: Field Drawing Register	Page 32
Appendix Five: Sample Register	Page 33
Plates	Page 34

List of Figures and Tables

Figure 1: General location map	Page 8
Figure 2: Detailed location map	Page 9
Figure 3: Pre-excavation plan of site	Page 10
Figure 4: Post-excavation plan of site	Page 15
Figure 5: Plan of pit features (Context Nos. 207 and 212)	Page 16
Figure 6: South-west facing section of pits (Context Nos. 207 and 212)	Page 16
Figure 7: Post-excavation plan of pit feature (Context No. 214)	Page 17
Figure 8: South-west facing section of pit (Context No. 214)	Page 17
Figure 9: East facing section of Context Nos. 204 and 216	Page 18
Figure 10: Oxcal plot of radiocarbon dates from burnt mounds	Page 21
Table 1: SMR sites in vicinity of Rossmacaffry	Page 5
Table 2: Radiocarbon dates from medieval burnt mounds	Page 20

List of Plates

Plate 1: Pre-excavation view of site	Page 34
Plate 2: Pre-excavation view of Context Nos. 207 and 212	Page 35
Plate 3: Post-excavation view of Context Nos. 207 and 212	Page 36
Plate 4: Excavation of field drain Context No. 209	Page 37
Plate 5: South-west facing section of Context No. 214	Page 38
Plate 6: Post-ex of Context No. 214	Page 39
Plate 7: Example of burnt sandstone from Context No. 213	Page 40
Plate 8: Overall shot of excavated features at Rossmacaffry	Page 41

1 Summary

1.1 Introduction

1.1.1 A small scale excavation of archaeological features identified through topsoil stripping of an application site at Rossmacaffry, Co. Fermanagh (L/2005/2978/F) was carried out by members of the Centre for Archaeological Fieldwork during the 4th–12th June 2007. The excavation identified the remains of a ploughed out burnt mound, as well as associated pits underlying the spread of burnt mound material.

1.1.2 The initial investigation constituted the mechanical removal of topsoil deposits to the surface of the natural subsoil in two areas, the application site and the access lane to the application site (Figure 2). This work was carried out during the 14th – 15th May 2007, and was funded by the landowner. The follow up excavation in June was carried out on behalf of and funded by the Environment and Heritage Service: Built Heritage

1.2 Aims

1.2.1 The primary aim of the excavation was to investigate the features of archaeological potential identified during the initial topsoil stripping. As the site was intended to be developed, excavation was deemed necessary.

1.3 Excavation

1.3.1 Archaeological excavation at Rossmacaffry uncovered a spread of burnt sandstone within a charcoal rich clay loam (Context No. 204). This spread directly overlay the subsoil as well as two pits (Context Nos. 214 and 216), presumably associated with the use of the burnt mound. Two other pits were also identified, one cutting the spread of burnt mound material (Context No. 207), as well as one stratigraphically isolated from the burnt mound material (Context No. 212). The spread of burnt mound material (Context No. 204) was thin (average depth 0.2m) and most likely truncated as a result of ploughing and agricultural improvement of the site.

1.3.2 Towards the north of the excavation area, a clay filled pit (Context No. 207) that cut both the spread of burnt mound material (Context No. 204), as well as an earlier sub circular pit (Context No. 212) was uncovered. The fill (Context No. 205) of this later pit (Context

- 207) was a grey sticky clay. The homogenous nature of this deposit suggests that this feature was rapidly backfilled rather than being left open to silt up naturally.
- 1.3.3 Upon removal of the spread of burnt mound material (Context No. 204), two pits were revealed cutting the natural subsoil (Context No. 203). The larger of these (Context No. 214) was filled by two deposits. The primary fill (Context No. 213) consisted of a charcoal rich grey clay with numerous inclusions of large rounded and sub-angular heat shattered sandstone. This deposit (Context No. 213) was capped by a relatively thick layer of mid to light orange clay (Context No. 211), which at the time of excavation appeared very similar to the natural subsoil (Context No. 203). It is assumed that this deposit (Context No. 211) represents redeposited subsoil, possibly derived from the excavation of the other pits associated with the use of the burnt mound. A similar sequence of deposits was encountered in the smaller pit (Context No. 216), where by the primary fill was heat shattered sandstone in a charcoal matrix (Context No. 215) overlain by redeposited subsoil (Context No. 217).
- 1.4 *Results*
- 1.4.1 The excavation proved successful in that the features of archaeological significance were excavated in advance of the development of the site. It is envisaged that post-excavation analysis of the samples retrieved during the excavation will shed further light on the date and function of the archaeological features present at Rossmacaffry.
- 1.5 *Recommendations*
- 1.5.1 It is recommended that all of the bulk samples recovered during the excavation are fully processed. No artefacts were recovered, nor were any structural features observed during the excavation that would indicate or suggest a date or function of the burnt mound at Rossmacaffry. Careful processing of the soil samples is needed to retrieve any materials (artefacts, charred seeds, bone, charcoal etc) that may have been missed during the excavation and that might assist with the interpretation of the site.
- 1.5.2 It is recommended that four samples from secure contexts submitted for radiocarbon dating following the processing of the soil samples. The stratigraphically earliest feature on site (Context No. 212) was filled by a charcoal rich clay deposit (Context No. 208) which, following processing of the samples would prove suitable for dating. It is also recommended that dates are obtained from the largest of the pits (Context No. 214), and

the rectilinear pit (Context No. 216) that were both covered by the spread of burnt mound material, as well as from the general spread of burnt mound material itself (Context Nos. 204/210).

- 1.5.3 It is recommended that an article based on the results of the excavation is prepared for publication in the *Ulster Journal of Archaeology*, as well as a short note in the Excavations Bulletin.

2 Introduction

2.1 General

- 2.1.1 The following report details the preliminary results of the archaeological excavation of a burnt mound in Rossmacaffry townland, Lisnaskea, Co. Fermanagh. The excavation took place following the identification of features of potential archaeological significance during initial topsoil stripping conducted by the author under the same licence (AE/07/78) in May 2007. The subsequent archaeological excavation took place between the 4th and the 12th June 2007 and was carried out by members of the Centre for Archaeological Fieldwork (CAF), Queen's University Belfast.
- 2.1.2 The excavation was directed by Brian Sloan of the CAF under the licence No. AE/07/78. The initial evaluation was carried out on behalf of, and funded by, the landowner Mr. John Lynch. The follow up excavation was carried out on behalf of, and funded by, the Environment and Heritage Service: Built Heritage.

2.2 Background

- 2.2.1 The townland of Rossmacaffry lies roughly 3km to the south-west of the town of Lisnaskea, Co. Fermanagh, at an altitude of approximately 50m above sea level (Figure 1). The site is intended to be used for the construction of a building, on a north facing slope that runs down towards the Colebrook River (Planning ref: L/2005/2978/F). The site (roughly 600m²) is located within a roughly rectangular field, the boundaries of which are delineated by wire and post fences, interspersed with mature trees and hedgerows. The surrounding landscape consists of predominantly pastoral agricultural land, interspersed with residential dwellings.
- 2.2.2 The excavation of archaeological features at Rossmacaffry was the second phase of archaeological work at the site. The first phase consisted of the monitoring of topsoil stripping of the application site and of the access lane to the site, conducted by Brian Sloan of the CAF. The initial programme of works was carried out during the 14-15th May 2007 (Sloan 2007, 2).
- 2.2.3 The results of the topsoil stripping indicated that archaeological features were present in the application area. On removal of the topsoil, a large crescent shaped spread of burnt

stone within a charcoal rich stratum was observed. This feature was interpreted as being the remains of a burnt mound (Figure 3).

2.3 Surrounding archaeological landscape

2.3.1 The sites and monuments record detail eight sites of archaeological interest within a 1km radius of the application site at Rossmacaffry. These sites are outlined in Table 1:

SMR NO.	Grid Reference	Site Type
FER 245:007	H 3377 3473	Multiperiod graveyard
FER 245:014	H 3338 3317	Early Christian counterscarp rath
FER 245:015	H 3347 3321	Undated enclosure
FER 245:016	H 3273 3253	Post-medieval mass rock
FER 245:017	H 3464 3277	Early Christian platform rath
FER 245:030	H 3251 3322	Early Christian crannog
FER 245:034	H 3479 3328	Early Christian crannog
FER 245:039	H 3320 3280	Undated enclosure

Table 1: Archaeological sites within 1km of Rossmacaffry (NISMR).

2.3.2 The sites of archaeological significance in the vicinity of the development site indicate a predominance of Early Christian activity. Immediately adjacent to the application site, there is a substantially disturbed counterscarp rath (FER 245:014), and the early editions of the Ordnance Survey 6" maps (1835 and 1908) show this in conjunction with another 'fort'. All above ground features of this secondary 'fort' had been destroyed prior to the publication of the 1954 edition. However, the location of this site was uncovered following archaeological mitigation prior to the construction of a residential dwelling in 2000 by Stiofan O Cathmhaoil, under planning reference No. L/2000/1286/O.

2.3.3 The place name evidence is interesting and also lends support to the view that there was quite substantial activity in this area during the Early Christian and Medieval periods. 'Rossmacaffry' means Macaffry's promontory, and probably relates to the counterscarp rath (FER 245:014). It has been argued that this name is a derivation from the earlier 'Ballymacaffry' which means Macaffry's settlement. Both Townland names are connected with a clan of that name, a sub-sept of the Maguires, who were active in this area from at least the 14th century (Kerr 2005, 6).

2.4 *Geological background (provided by Naomi Carver)*

2.4.1 The site of Rossmacaffry is located close to the shores of Upper Lough Erne in an area of complex geology consisting predominantly of Carboniferous sedimentary rocks which have been disturbed by faults and igneous intrusions (Mitchell 2004, 23). To the north is the Clogher Valley Fault which runs from Clogher south-east to County Leitrim. The site is located directly on the Bundoran Shale Formation (BUNS) which consists of fossil-rich, dark grey, calcareous mudstone. In the immediate area is the similar formation of Benbulbin Shale (BBSF) which also consists of grey calcareous mudstone, along with the Darty and Ballyshannon Limestone Formations (DARL and BAL respectively). Immediately to the west of the site is an intrusive dolerite dyke which extends for approximately 30km and is one of several in the immediate area. The parent rock material and later glacial activity, as well as the sites location on the shores of Upper Lough Erne, has produced subsoil of 'Calp' till overlain by poorly drained surface water gley (Cruickshank 1997, 86).

2.5 *Aims and objectives*

2.5.1 Due to the application site being intended for use for the construction of a residential dwelling, the focus of the excavation was to determine the extent of the burnt mound spread and to establish whether any other features, such as a trough, were preserved *in situ*.

2.5.2 Given the nature of burnt mounds, it was not anticipated that artefactual material would be recovered from the excavation (O'Sullivan & Downey 2004, 35). It is intended that a series of radiocarbon dates is obtained from the samples gathered during the excavation to further our understanding of the feature.

2.6 *Archiving*

2.6.1 Copies of this report have been deposited with the Environment and Heritage Service: Built Heritage. All site records are temporarily archived within the Centre for Archaeological Fieldwork, School of Geography, Archaeology and Palaeoecology, Queen's University Belfast.

2.7 *Credits and acknowledgements*

- 2.7.1 The excavation was directed by Brian Sloan of the Centre for Archaeological Fieldwork (CAF). The excavation crew consisted of Clare Mc Granaghan and David McIlreavy, both of the CAF.
- 2.7.2 Assistance during the course of this excavation and the preparation of this report was kindly provided by; Naomi Carver (CAF), Colm Donnelly (CAF), Edith Gowdy (Environment and Heritage Service), Emily Murray (CAF), John O'Neill (University College Dublin), Philip Macdonald (CAF), Richard McClenaghan (CAF), Ronan Mc Hugh (CAF), and Sapphire Mussen (CAF). The illustrations were produced by Philip Barrett (CAF)
- 2.7.3 Many thanks are due to the landowner, John Lynch for facilitating the programme of archaeological investigations.



Figure 1: General map showing the location of Rossmacaffry townland (green dot), west of Lisnaskea in Co. Fermanagh.

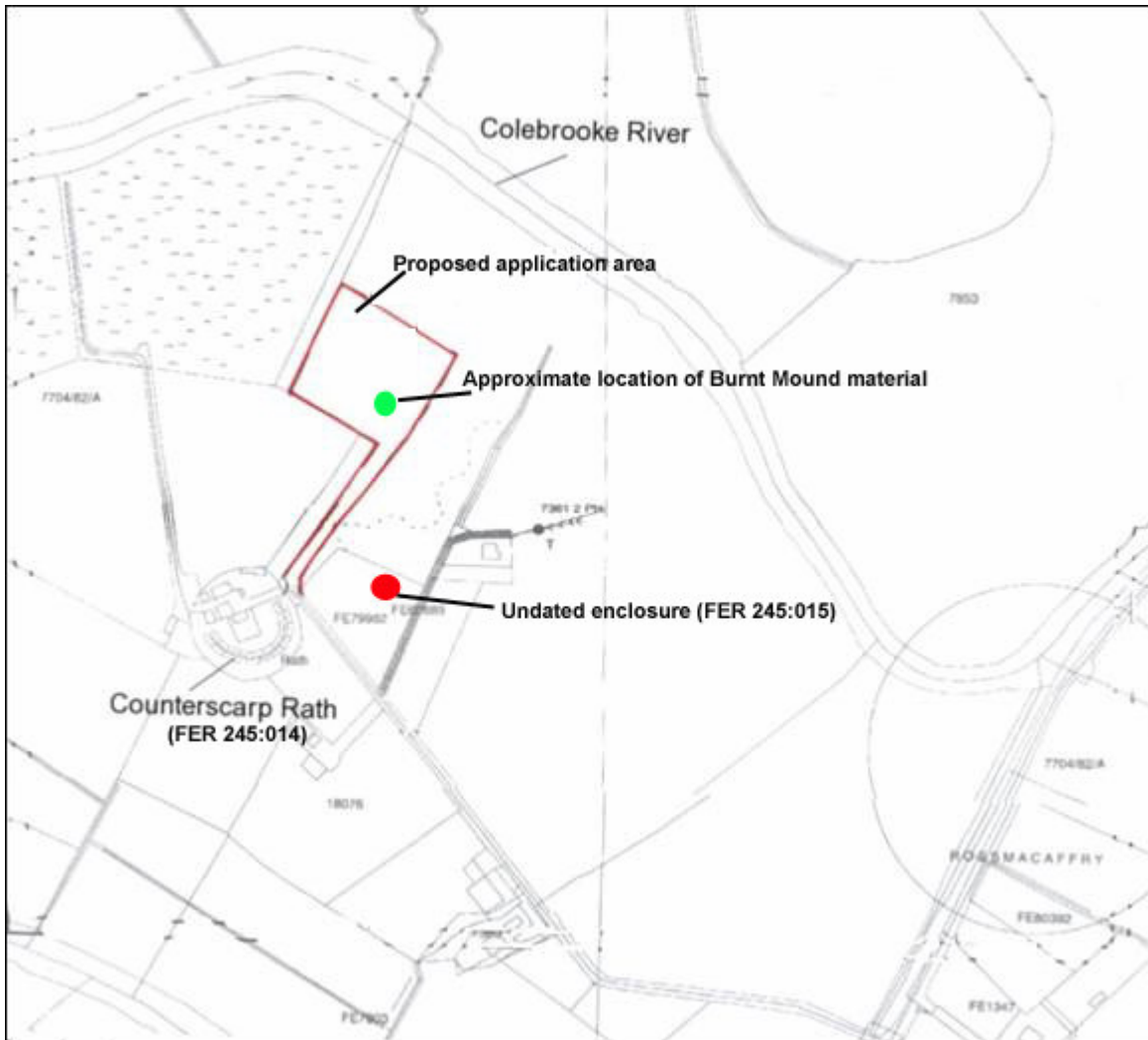

Figure 2: Detailed map showing the location of the application site in relation to the Colebrooke River, the counterscarp path (FER 245:014) and the undated enclosure (FER 245:015).
NB: This map was annotated and included in the original evaluation report for this site (Sloan 2007, 12).

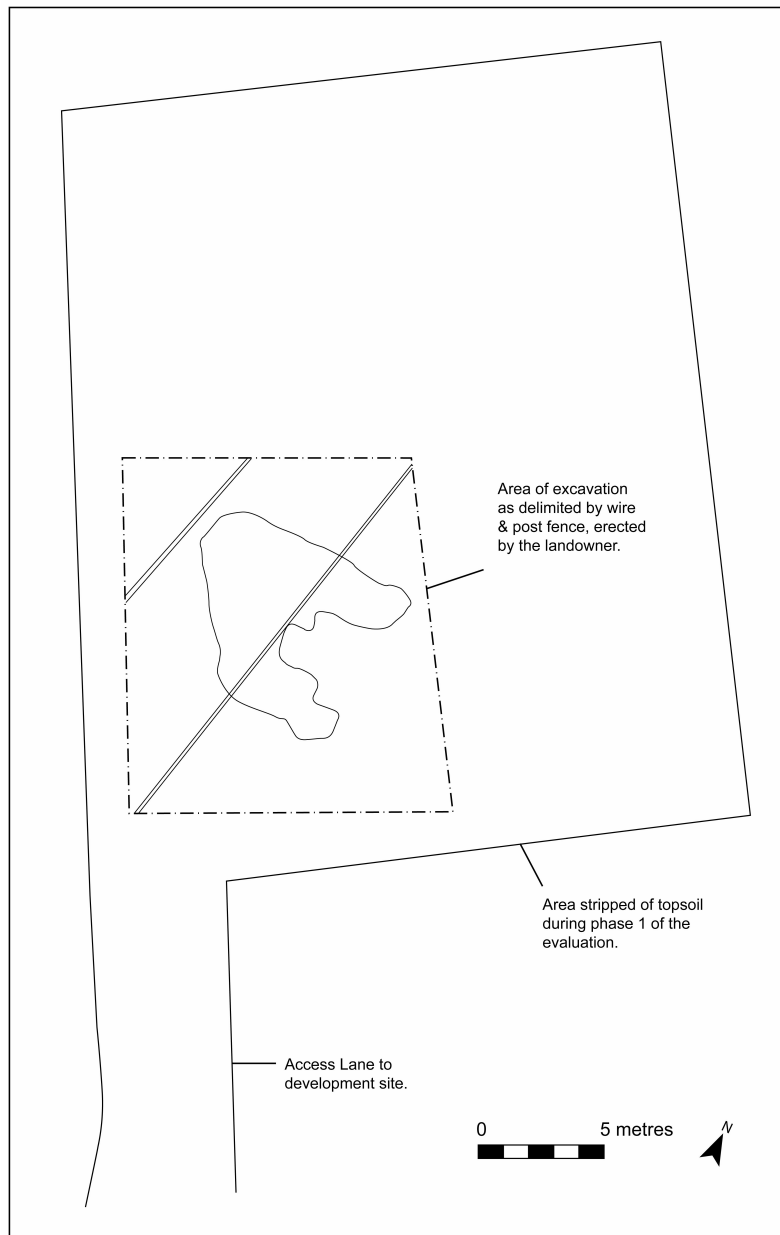

Figure 3: Pre-excitation plan of Rossmacaffry showing the access lane, development area, excavation area and spread of burnt mound material.

NB: The access lane is shown in this detailed map as extending further west than that shown in Figure 2. This was due to the presence of a gate leading into the field which the landowner wished to avoid moving.

3 Account of the excavation

3.1 Methodology

3.1.1 The sod, topsoil and plough soil was mechanically removed to the surface of the subsoil during phase 1 of the archaeological works on site. It was during this phase that the spread of burnt material was uncovered and the need for further archaeological work identified. The landowner, John Lynch, had erected a post and barbed wire fence around the area of archaeological significance prior to the commencement of the phase 2 excavation. The area this fence enclosed delineated the excavation area, and measured roughly 12m (north/south) by 13.5m (east/west). The field is currently used for pasture, although the presence of a cultivation soil (Context No. 202) suggests that the area had been ploughed in the past.

3.1.2 Context numbers were assigned to the different layers during the mechanical excavation of the topsoil in phase 1 of the programme of works. The access lane was designated 'Trench 1' and the development area designated 'Trench 2' during the initial evaluation (Phase 1). The same context numbers assigned to the application site and spread of burnt mound material in Phase 1 were continued through out the subsequent excavation (Phase 2). The context record was created using the standard context recording method. The list of contexts is reproduced as Appendix One, and the photographs taken during the excavation are reproduced as Appendix Three. The remainder of the site records are reproduced as the Field Drawing Register (Appendix Four) and the Sample Register (Appendix Five). No small finds were recovered during the course of either the monitoring of topsoil stripping or the excavation itself.

3.2 Account of the excavations

3.2.1 The Harris Matrix for the site is reproduced as Appendix Two. It is intended that this is referred to whilst reading the account of the stratigraphic sequence present on site. The results of both the monitoring exercise and the subsequent excavation have been integrated into the single account which follows.

3.3 *Phase 1- monitoring of topsoil stripping*

3.3.1 The topsoil was stripped to the surface of the natural subsoil over the 14th and 15th of May 2007. Both the access lane and the application site were stripped to the surface of the natural subsoil under archaeological supervision. The findings of this monitoring exercise were to provide the focus for the subsequent excavation in June 2007.

3.3.2 The access lane ran from the edge of the laneway towards the north-east to the application site, and measured approximately 110m in length by 6m in width. The area was mechanically excavated to the surface of the natural subsoil, which was encountered at an average depth of 0.3m. The sod and topsoil in the access lane (Context No. 101) consisted of a mid to dark brown silty loam. This deposit contained occasional inclusions of small rounded and sub-angular stones (average size: 30mm x 30mm x 20mm) and was on average, 0.2m deep. This layer stratigraphically overlay a dark brown silty cultivation soil (Context No. 102). This layer was similar in appearance to the topsoil, although contained a higher frequency of slightly larger stones (average size: 60mm x 50mm x 50mm). This deposit had an average thickness of 0.1m and directly overlay the natural subsoil (Context No. 103), which consisted of glacially derived orange gritty clay. No finds or features of archaeological significance were observed in this area.

3.3.3 The proposed location for the new dwelling lay to the north of the access lane. The area topsoil stripped measured roughly 22m south-west/north-east by 27m north-west/south-east. The subsoil in this area was encountered at an average depth of 0.25m. The sod and topsoil in the application site (Context No. 201) consisted of a mid to dark brown silty loam with occasional inclusions of small rounded and sub-angular stones (average size: 30mm x 30mm x 20mm) and was on average 0.1m deep. This deposit directly overlay a dark brown silty cultivation soil (Context No. 202) which was on average 0.15m thick. Again this deposit was similar in appearance to the topsoil (Context No. 201). Upon removal of the cultivation soil (Context No. 202) a crescent shaped spread of burnt stone within a stratum of charcoal rich soil/clay (Context No. 204) was observed. This spread was not investigated at this stage, but cleaned and planned (Figure 3).

3.4 *Phase 2- The excavation*

3.4.1 Following the identification of the burnt spread (Context No. 204) as being of archaeological significance, an excavation was commenced prior to the development of

- the site. This excavation took place during the 4th–12th June 2007 and was undertaken by members of the Centre for Archaeological Fieldwork, Queen's University Belfast.
- 3.4.2 Prior to the commencement of the excavation, the landowner had erected a post and barbed wire fence around the burnt spread, in an effort to keep cattle away from the area. This fence measured approximately 12m by 13.5m and formed the edge of excavation. Two baulks were established, perpendicular to each other, across the burnt spread to provide section edges for the excavated deposits and horizons (Figures 4 and 10).
- 3.4.3 A modern field drain cut across the burnt mound spread (Context No. 204). The cut for the field drain (Context No. 209) measured 0.16m in width and was excavated to a depth of 0.31m in the southern area of the trench. Excavation of this feature ceased at this level due to a strong smell of petrol/chemicals emanating from the drain. The fill (Context No. 206) of the drain (Context No. 209) consisted of a loose matrix of angular gravel pieces (average size: 30mm in length). Another field drain was observed to the west of the burnt mound spread. However, due to this being an isolated feature that did not impinge on the burnt mound, it was left unexcavated.
- 3.4.3 Following the clean up of the site, a feature was observed cutting the burnt mound material (Context No. 204). This feature was originally observed as a spread of greenish grey silty clay (Context No. 205), although upon investigation it proved evident that this deposit was the fill of a rectilinear pit (Context No. 207). This pit had a maximum measurement of 1.40m in length (south-west/north-east), 0.78m in width (north-west/south-east) and 0.32m in depth. The north-western side of this pit (Context No. 207) cut the spread of burnt mound material (Context No. 204), whilst the south-eastern side of the pit (Context No. 207) appeared to cut an earlier pit (Context No. 212) that was filled with a charcoal rich silty clay loam (Context No. 208). Although this primary pit (Context No. 212) is evidently earlier than the rectilinear pit (Context No. 207), no stratigraphic relationship existed between it and the spread of burnt mound material (Context No. 204).
- 3.4.4 The burnt mound material (Context No. 204) was found to vary in depth from 0.03m to a maximum of 0.28m. In the northern end of the excavation area, the burnt spread (Context No. 204) appeared to be two deposits of burnt stone and charcoal and was thus assigned a separate number (Context No. 210). However, these two deposits are most likely to be the same spread, and the difference in the depth or the apparent separation of the spread is probably due to an undulating subsoil surface.

- 3.4.5 The removal of the burnt mound spread (Context No. 204) revealed two sub-rectangular pits cut into the surface of the natural subsoil (Context No. 203). The largest of these pits was observed as a steep cut (Context No. 214) which had a concave base (maximum dimensions: 1.77m north/south by 1.61m east/west by 0.65m deep). This pit was filled with a stratum of burnt and fragmented sandstone within a matrix of charcoal rich sand clay (Context No. 213). Interesting to note is the size of the sandstone fragments (average size: 0.2m by 0.1m) recovered from the fill of this pit (Context No. 213) which were substantially larger than those present in the general burnt stone spread (Context No. 204) (Plate 7). The size difference may suggest that the stones in the fill of this feature were not subjected to the same heat, or were not immersed in water that would cause them to fragment. A relatively thick layer of sticky orange yellow clay (Context No. 211) formed the upper fill of this pit (recorded as 0.25m thick). At the time of excavation, this deposit was similar to the natural subsoil around it, and was thus interpreted as redeposited subsoil, presumably cast up from the excavation of the other features on site.
- 3.4.6 The other pit revealed by the removal of the burnt mound spread (Context No. 204) was slightly smaller to that described above. The maximum dimensions recorded for this feature (Context No. 216) was: 0.58m north/south by 0.80m east west by 0.48m deep. The lower most fill (Context No. 215) of this feature consisted of relatively large thermally shattered pieces of sandstone (average size: 0.1m by 0.15m) within a charcoal rich clay. Directly above this fill was another deposit of sticky orange yellow clay, similar to that which 'capped' the larger pit (Context No. 211).
- 3.4.7 As stated above, the natural subsoil (Context No. 203) was encountered at a maximum depth of 0.28m and was directly underneath the spread of burnt mound material (Context No. 204). The burnt mound spread did not appear to be sitting in a cut or hollow, rather it lay directly on the natural subsoil (Context No.203). There was no evidence observed for the presence of a fossilised ground surface. The natural subsoil (Context No. 203) consisted of a sticky compact orange yellow clay.

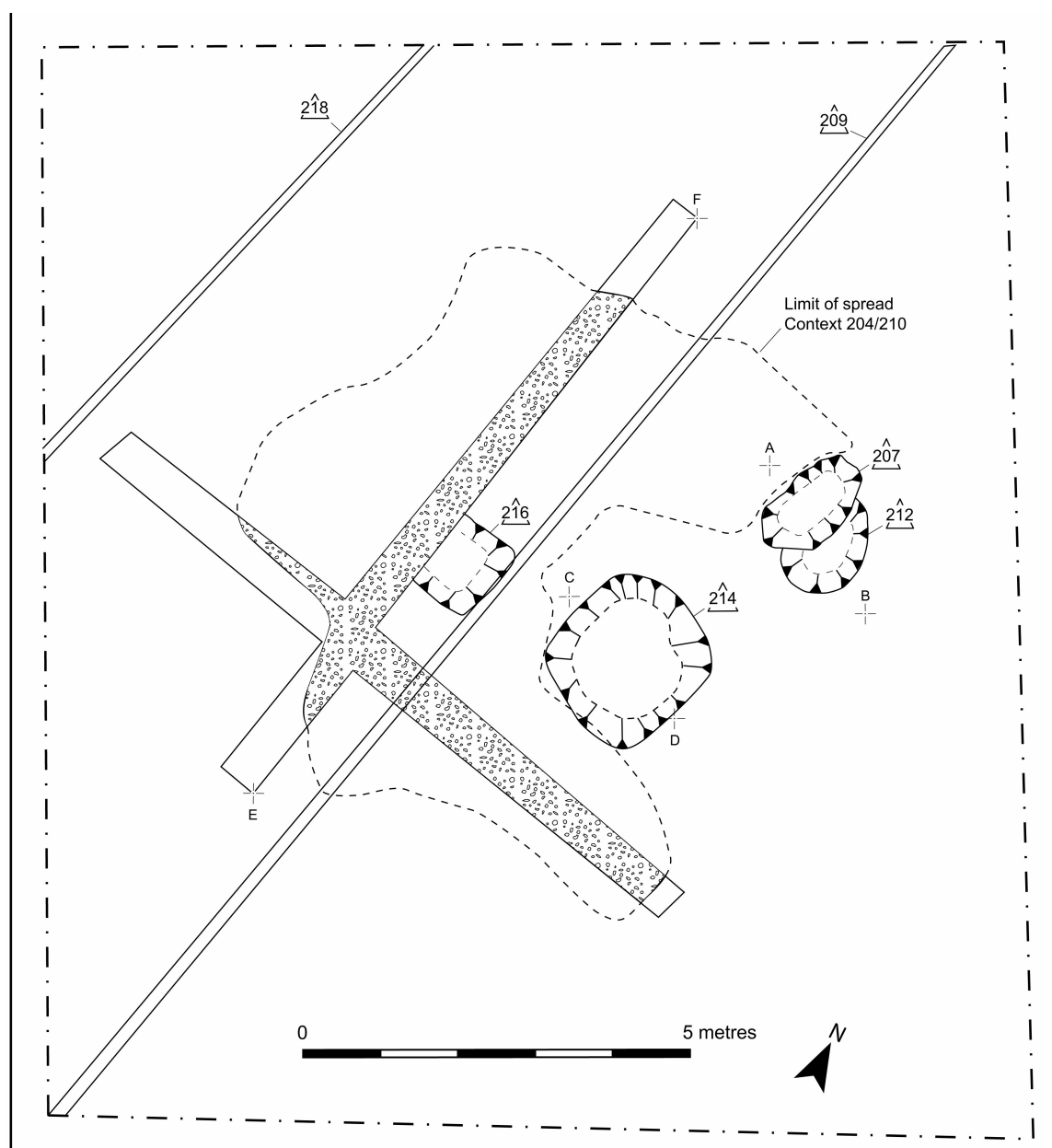

Figure 4: Post-excitation plan of the site

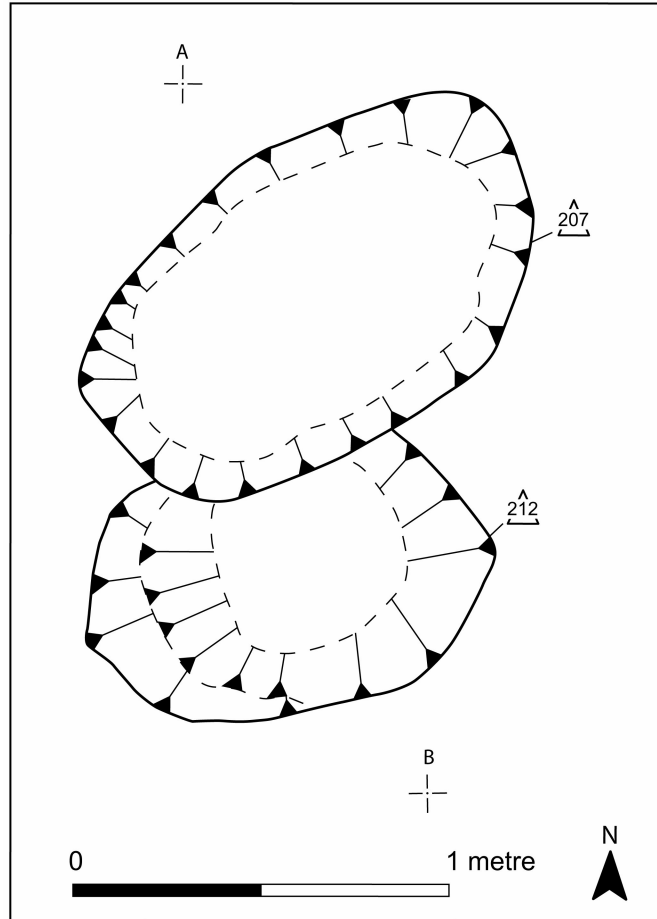

Figure 5: Post-excavation plan of pit features Context Nos. 207 and 212

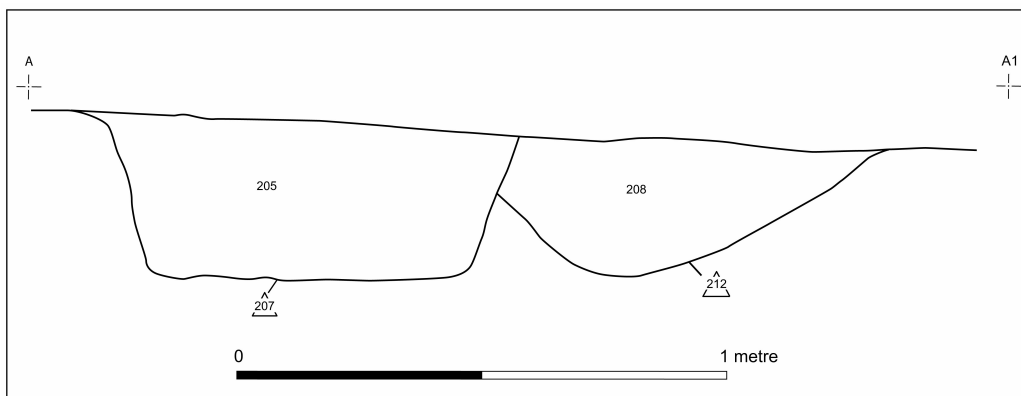

Figure 6: South-west facing section through pit features Context Nos. 207 and 212

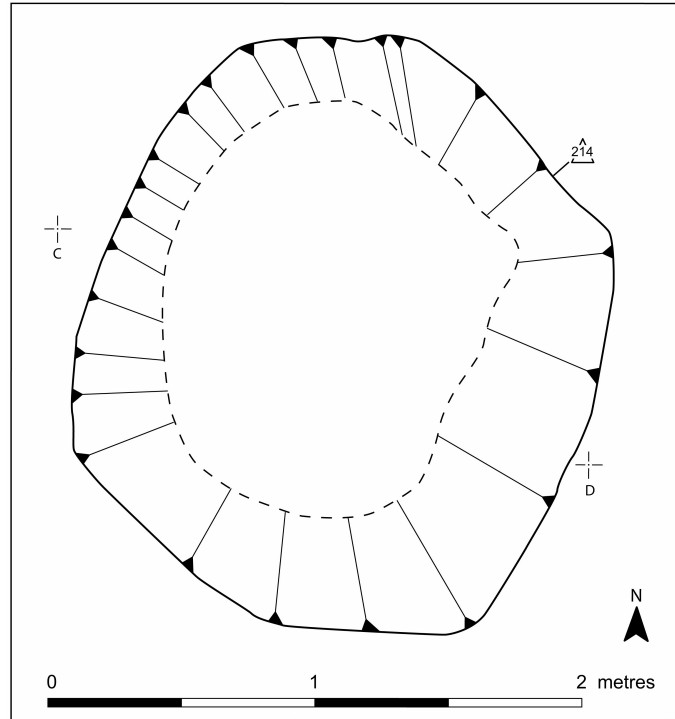

Figure 7: Post-excitation plan of pit feature Context No. 214.

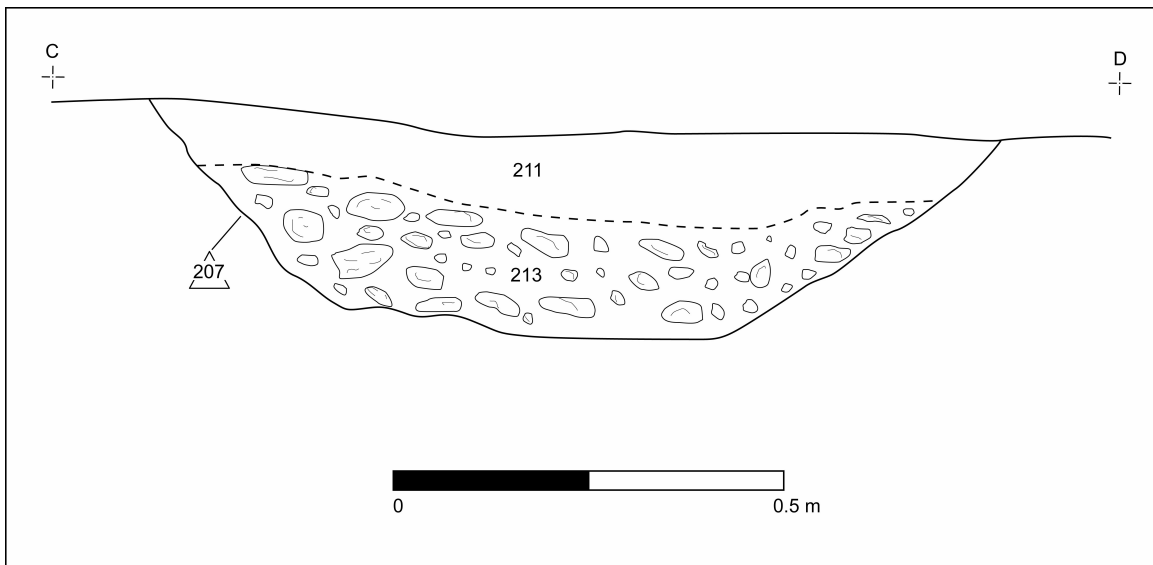

Figure 8: South-west facing section of pit (Context No.214) showing fills (Context Nos. 211 and 213).

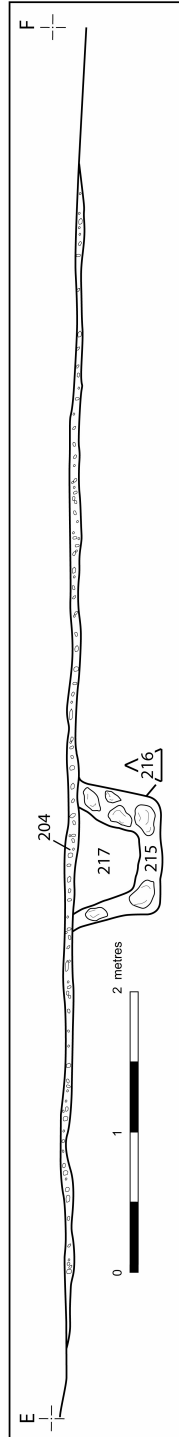

Figure 9: East-facing section through burnt mound spread (Context No. 204) showing pit feature (Context No. 216).

4 Discussion

4.1 Introduction

4.1.1 The excavations at Rossmacaffry were successful in that the burnt mound was excavated and found to be overlying a series of features associated with its use. Four pits of varying size were identified, some of which may be tentatively regarded as representing the remains of troughs. However, this is by no means certain due to the lack of a wood lining in any of these features, characteristic of many burnt mounds excavated in Ireland.

4.1.2 The condition of preservation of the burnt mound spread at Rossmacaffry is consistent with the majority of burnt mound discoveries in Ireland. Prior to excavation, there was no above ground trace or anything that may have suggested the presence of a burnt mound in the general area. The original mound has been ploughed out by centuries of agriculture. The original monitoring exercise was undertaken due to the proximity of the application site to two sites of probable Early Christian date; the counterscarp rath (FER 245:014) and the undated enclosure (FER 245:015). The application site overlooks a meander in the Colebrooke River, and the general area is quite marshy as it floods during periods of heavy rain (John Lynch *pers comm.*). This landscape is characteristic of the favourable locations for burnt mounds, as described in Waddell:

“They [burnt mounds] are usually close to water, often near a stream, or by a lake or river, or in marshy ground. They sometimes occur in groups, clusters to two to six occasionally located within quite a small area” (Waddell 2000, 174).

4.1.3 This description may tentatively suggest that more burnt mounds may be in the area around the application site. Should any more of the general vicinity be proposed for development, archaeological mitigation is advised due to the possibility of further mounds in the area.

4.2 The function of burnt mounds

4.2.1 Burnt mounds are one of the most prevalent archaeological site types discovered in Ireland, partly due to the increase in archaeological mitigation of road schemes in the Republic of Ireland, in recent years. They are found all over Ireland, with particular concentrations in the south-west and west. Cork has over 2000 recorded examples and this figure is annually expanding (Waddell 2000, 174; O’Sullivan & Downey 2004, 37). In

the Northern part of the country, a concentration is noted in County Fermanagh, although in general they seem to be more common in areas west of the River Bann. This may be due to a bias in the distribution of fieldwork rather than a genuine reflection of the distribution trends of this monument type (O’Sullivan & Downey 2004, 37).

4.2.2 The function of the burnt mound is one of great debate. Historical documents indicate both cooking and washing was carried out at these sites, in addition brewing, textile manufacture and the extraction of fats and lipids from hides are all suggested as being possible functions (David McIlreavy *pers comm.*). *The Romance of Mis and Dubh Ruis* (written in 1769 but probably of earlier date) details the use of heated stones to cook a deer, with the remaining heated water utilised for washing (O’Neill 2004, 80). Another episode was related by French (1899, 43) who described Irish soldiers using heated stones to cook in a water-filled (leather?) bag in 1544 AD.

4.2.3 Burnt mounds are generally attributed to Bronze Age activity, with the bulk of the excavated examples dated falling between 1800-800 BC. Calibrated dates provided by excavated examples from Ireland, Britain and Scandinavia (Figure 10), show a uniformity of radiocarbon dates falling around the Middle to Late Bronze Age. However, some have produced earlier dates and some show evidence for being used in the Early Christian and Medieval periods (O’Sullivan & Downey 2004, 37). Of the dated examples of burnt mounds, only 5% produced calibrations attested to the ‘historical’ ages (O’Neill 2004, 84). Table 2, cited below, gives three examples of excavated burnt mounds that provided dates in the Early Christian and Medieval periods. The references to burnt mounds in such documentary sources as the *Annals* and poetry dating to the medieval and post-medieval periods, may be an attempt by the writers to add a scene of mysticism to such a prominent feature on the landscape.

Site	County	Calibrated Date
Killoran, Site 23	Tipperary	660 – 880 AD
Nenagh	Tipperary	1270 – 1420 AD
Ballymount Great	Dublin	1400 – 1630 AD

Table 2: Excavated burnt mounds producing calibrated radiocarbon dates from the Early Christian and Medieval periods (after O’Neill 2004, 83).

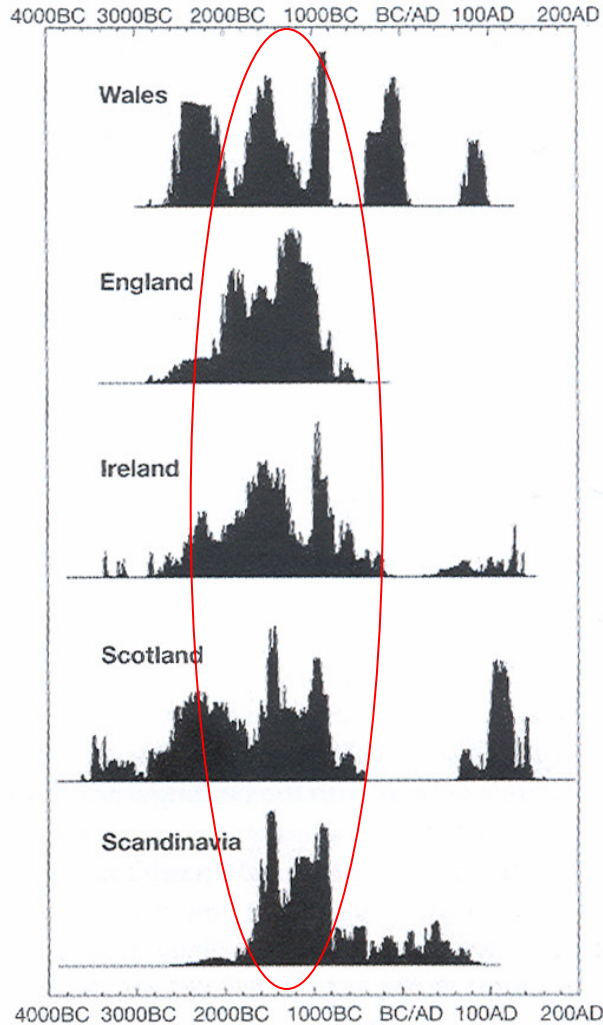

Figure 10: Calibrated radiocarbon dates for excavated burnt mounds (after O'Neill 2004, 83). The circled area shows the majority of sites from Ireland and the rest of Europe producing dates from the Middle to Late Bronze Age.

4.3 *Similar sites in Co. Fermanagh*

- 4.3.1 Burnt mounds are particularly prevalent in Co. Fermanagh, with approximately 400 examples having been identified (Ronan Mc Hugh *pers comm.*). The abundance of this site type may be due to much of the county being interspersed with lakes and rivers, ideal locations for such a monument.
- 4.3.2 Several burnt mounds have been investigated and recorded in Fermanagh by Frederick Carroll in association with the Environment and Heritage Service during the early 1990's. Some of those identified and recorded were subject to brief excavation in the summer of

1994. In the majority of cases, excavation proved the remains to comprise a layer of burnt sandstone fragments within a dark loose stratum of charcoal rich soil. Examples of this were excavated in Derryvullan, Derrybrusk and Enniskillen (Carroll 1994). It is interesting to note that preserved troughs are not commonplace in the burnt mounds investigated by Carroll, and no wood lining was encountered in Rossmacaffry. This may suggest the deliberate destruction of the monument (if a wood lining was present in the first place) or an indication of the preservation qualities of the soil in this part of Fermanagh. Rossmacaffry was certainly drained during modern times as an agricultural improvement scheme (presence of the field drains Context Nos. 209 and 218 testify this), and this may have been carried out at other sites that may have previously been waterlogged. This drainage would affect the preservation qualities of the soil in which the burnt mounds were situated.

4.4 *Conclusions*

- 4.4.1 The excavation at Rossmacaffry, Lisnaskea, Co. Fermanagh revealed the remains of a burnt mound and associated subsoil-cut features. Unfortunately, due to their character and the state of preservation at such sites, no artefactual material was recovered or structural evidence observed which may suggest a date or function of the burnt mound. Due to the majority of the excavated sites providing a date in the Middle to Late Bronze Age, it is envisaged that the Rossmacaffry example will fall within this parameter. Recommendations for further work are given in Section 5 of this report, including details of a radiocarbon dating programme to bring this project to a meaningful conclusion.

5 Recommendations for further work

5.1 Introduction

5.1.1 The excavations carried out at Rossmacaffry did not produce any artefactual evidence that might shed light on the date and function of the burnt mound. It is for this reason that it is proposed that the samples gathered from the excavation are fully processed in an effort to gain all possible information on this site. The following recommendations are further detailed in the accompanying Costed Assessment for this report.

5.2 Soil sample processing

5.2.1 Thirteen samples, totalling approximately 60kg of soil, were recovered from the excavations at Rossmacaffry. It is recommended that these samples are processed in their entirety to assess the level of preservation of charcoal, macro-fossils and small artefactual remains that may have been missed during the excavation.

5.3 Radiocarbon dating programme

5.3.1 Following processing of the soil samples, it is recommended that a number of samples are submitted for radiocarbon dating from certain features of the burnt mound. The primary pit (Context No. 212) was filled with a charcoal rich deposit (Context No. 208). Due to the possibility that this is the earliest stratigraphical feature on site, it is proposed that a radiocarbon date is obtained from the fill (Context No. 208).

5.3.2 Two pits were revealed under the burnt mound spread (Context No. 204). The largest of these (Context No. 214) was filled with a charcoal rich deposit (Context No. 213). Due to the size and depth of this feature, and the fact that the burnt stones recovered from this fill were substantially larger than anywhere else on site, it is recommended that a date is gained for this feature. Another date obtained from the lowermost fill of the smaller pit (Context No. 215) would be beneficial to see if these features are contemporary.

5.3.3 It is also recommended that a radiocarbon date is gained for the general spread of burnt mound material (Context No. 204).

5.4 *Publication*

- 5.4.1 Following the processing of the soil samples and the implementation of the radiocarbon dating programme, it is recommended that the results of the excavation are published in the *Ulster Journal of Archaeology*. It is also recommended that a short note is prepared for the annual *Excavations Bulletin*.

6 Bibliography

- Carrol, F. 1994. *Excavations Bulletin 1994*. www.excavations.ie
- Cruickshank, J.G. (ed.) 1997. *Soil and Environment: Northern Ireland*. Belfast
- French, J. F. M. 1899. Notes on the family of Sherlock chiefly gathered from the state papers and other official documents. *Journal of the Co. Kildare Archaeological Society* 2, 33-47, as cited in O'Neill 2004.
- Kerr, T. 2005. *Archaeological Impact Assessment: AIA004 (amended), Rossmacaffry, Co. Fermanagh*. Unpublished Archaeological Assessment produced by the Centre for Archaeological Fieldwork, Queen's University Belfast.
- Mitchell, W.I. (ed.) 2004. *The Geology of Northern Ireland: Our Natural Foundation*. Geological Survey of Northern Ireland, Belfast.
- O'Neill, J. 2004. Lapidibus in igne calefactis coquebatur: The Historical burnt mound 'tradition'. *The Journal of Irish Archaeology* Xii – Xiii, 79-85.
- O'Sullivan, M. & Downey, L. 2004. Fulachta fiadh. *Archaeology Ireland Vol. 17, Issue No. 66. Spring 2004*, 35-37.
- Sloan, B. 2007. *Monitoring at Rossmacaffry Townland, Lisnaskea, Co. Fermanagh*. CAF Monitoring report No. 90. Unpublished Monitoring report produced by the Centre for Archaeological Fieldwork, Queen's University Belfast.
- Waddell, J. 2000. *The Prehistoric Archaeology of Ireland*. Galway University Press, Galway.

Appendix One: Context Register

Context No.	Description
201	Sod and topsoil (from monitoring exercise)
202	Plough soil (from monitoring exercise)
203	Natural subsoil (from monitoring exercise)
204	Spread of burnt mound material (from monitoring exercise)
205	Clay fill of Cxt. 207
206	Stony fill of cut Cxt. 209
207	Cut of pit, filled by Cxt. 205
208	Charcoal rich fill of Cxt. 212
209	Cut for field drain, filled by Cxt. 206
210	Spread of burnt mound material. Same as Cxt. 204
211	Redeposited natural overlying Cxt. 204
212	Cut of pit, filled by Cxt. 208, cut by Cxt. 207
213	Fill of pit Cxt 214, overlain by Cxt. 211
214	Cut of pit, filled by Cxt. 213
215	Fill of Cxt. 216
216	Cut of pit filled by Cxt. 215
217	Redeposited natural, upper fill of pit Cxt. 216

Appendix Two: Harris matrix

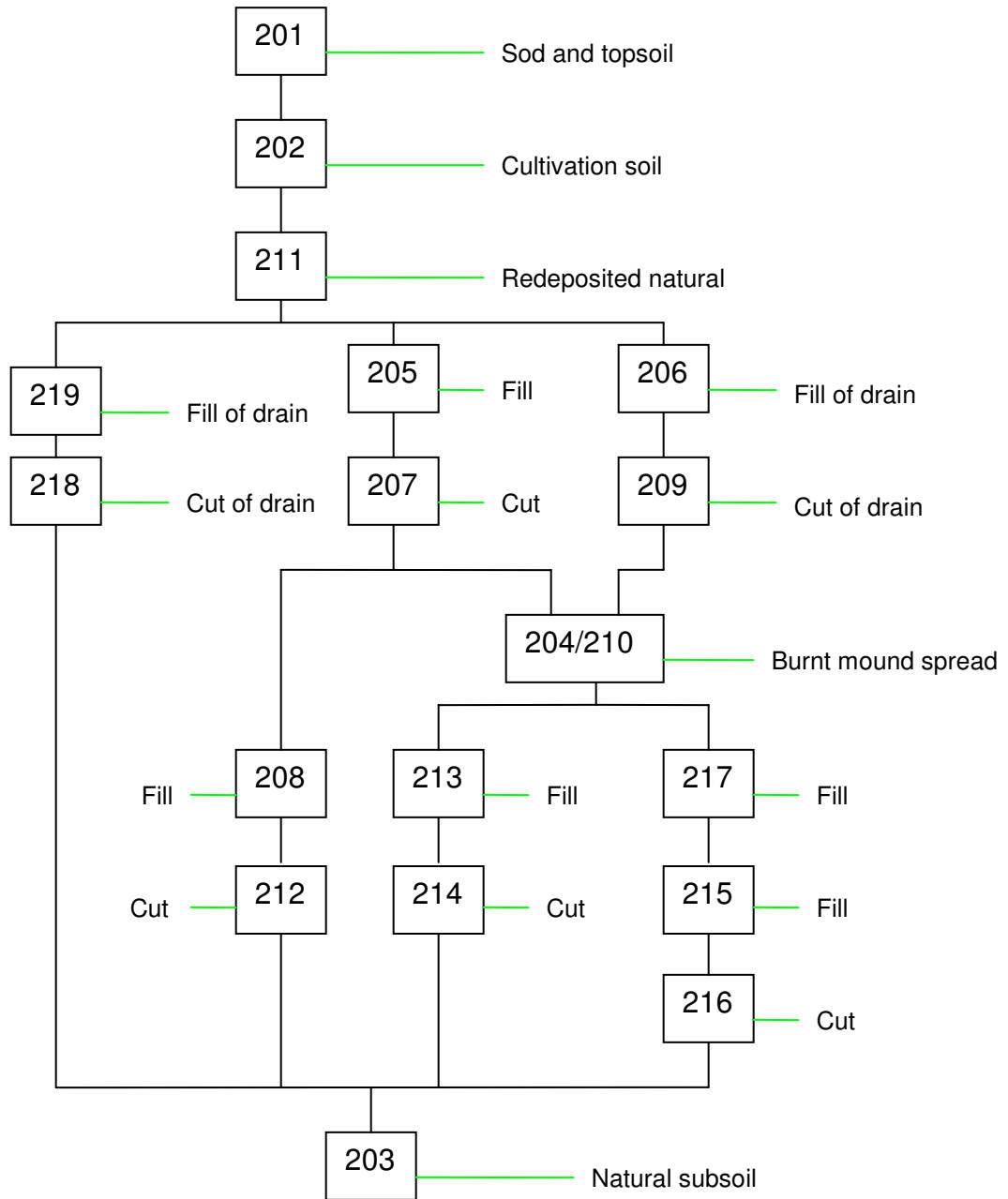

Appendix Three: Photographic Register

Jpeg #	Description
001	Cxt. 204 following cleanup, looking north-west
002	Cxt. 204 following cleanup, looking south-west
006	Cleaning up Cxt. 204, looking north
007	Cleaning up Cxt. 204, looking north-east
008	Cleaning up Cxt. 204, looking north-west
009	Cleaning up Cxt. 204, looking north
010	Cleaning up Cxt. 204, looking north
011	Cleaning up Cxt. 204, looking north-east
012	Working shot
013	Cxt. 204 following cleanup, looking north-east
014	Cxt. 204 following cleanup, looking north-east
015	Working shot looking west
016	Working shot
017	Working shot looking south-west
019	Cxt. 204 following cleanup, looking north
020	Cxt. 204 following cleanup, looking north-east
021	Detailed shot of Cxt. 204
022	Cxt. 204. looking north-west
025	Pre-ex shot of Cxt. 205, looking north
027	Pre-ex shot of Cxt. 205, looking north
028	Pre-ex shot of Cxt. 205, looking east
031	Pre-ex shot of Cxt. 205, looking east
032	Pre-ex shot of Cxt. 205, looking east
033	Pre-ex shot of Cxt. 205, looking north-west
034	Cxt. 204 following cleanup, looking north-west
036	Cxt. 204 following cleanup, looking north-east
038	Cxt. 204 following cleanup, looking north
039	Cxt. 204 following cleanup, looking north
040	Cxt. 204 following cleanup, looking north-west
043	Pre-ex shot of Cxt. 205, looking south
044	Working shot
045	Working shot
046	Excavation of Cxt. 209

Jpeg #	Description
047	Working shot
049	Working shot
050	Excavation of Cxt. 207
052	Excavation of Cxt. 207
053	Working shot
054	Working shot
055	Working shot, looking west
056	Working shot, looking west
057	Cxt. 207 showing band of Cxt. 208, looking east
058	Post-ex shot of Cxts. 207 and 212, looking north-east
061	Post-ex shot of Cxts. 207 and 212, looking south
062	Post-ex shot of Cxts. 207 and 212, looking north-west
063	Post-ex shot of Cxts. 207 and 212, looking north-west
065	Cxt. 214, showing fills Cxt. 211 and 213, looking north-east
066	Cxt. 214, showing fills Cxt. 211 and 213, looking north-east
067	Cxt. 214, showing fills Cxt. 211 and 213, looking north-east
068	Cxt. 214, showing fills Cxt. 211 and 213, looking north-east
070	Working shot
071	Working shot
072	Working shot
074	Post-ex shot of Cut Cxt. 214
075	Post-ex shot of Cut Cxt. 214
076	Post-ex shot of Cut Cxt. 214
077	Post-ex shot of Cut Cxt. 214
078	Burnt stones recovered from Cxt. 213
080	Burnt stones recovered from Cxt. 213
082	Burnt stones recovered from Cxt. 213
083	Burnt stones recovered from Cxt. 213
084	Post-ex shot of Burnt mound spread (Cxt. 204 and 210), looking north
086	Post-ex shot of Burnt mound spread (Cxt. 204 and 210), looking south-west
087	Post-ex shot of Burnt mound spread (Cxt. 204 and 210), looking south-west
088	Cxt. 216 showing fills Cxt. 215 (burnt fill) and Cxt. 217 (redeposited natural), looking west

Jpeg #	Description
090	Cxt. 216 showing fills Cxt. 215 (burnt fill) and Cxt. 217 (redeposited natural), looking west
092	Post-ex view of site
094	Post-ex view of site
095	Post-ex view of site
096	Post-ex view of site
097	Working shot
099	Post-ex view of site
100	Post-ex view of site
102	Post-ex view of site
103	Post-ex view of site
104	Post-ex view of site, looking north-east
105	Post-ex view of site, looking north-east
106	Post-ex view of site, looking north-east
107	Post-ex view of site, looking north-east
108	Post-ex view of site, looking south-east
109	Post-ex view of site, looking south-east
110	Post-ex view of site, looking south-east
112	Post-ex view of site, looking south-west
114	Post-ex view of site, looking south-west
115	Post-ex view of site, looking north-west
116	Post-ex view of site, looking north-west
117	Post-ex view of site, looking north
118	Post-ex view of site, looking north
120	Post-ex view of site, looking east
121	Post-ex view of site, looking east
123	Post-ex shot of Cxt. 207, 212 and 214, looking south
124	Post-ex shot of Cxt. 207, 212 and 214, looking south
125	Post-ex shot of Cxt. 207, 212 and 214, looking south
126	Post-ex view of site, looking west
127	Post-ex shot of cut Cxt. 216, looking west
128	Cut Cxt. 214, looking north
129	Cut Cxt. 214, looking north
130	Cut Cxt. 214, looking north
131	Cxts. 207 and 212, looking north

Jpeg #	Description
132	Cxts. 207 and 212, looking north
133	Cxts. 207 and 212, looking north-east
135	Cxts. 207 and 212, looking north-east
136	Post-ex view of site, looking west
137	Post-ex view of site, looking east
138	Post-ex view of site, looking north-east
139	Post-ex view of site, looking north-east
140	Post-ex view of site, looking north-east
142	Intersection of baulks, Quad C, looking south
143	Intersection of baulks, Quad C, looking south

Appendix Four: Field drawing register

Drawing No.	Type	Description
1	Plan	Plan of site completed during Phase 1 monitoring
2	Plan	Pre-ex plan of excavation area (Completed by EDM survey)
3	Plan	Pre-ex plan of Cxt No. 205 (fill) and Cxt No. 207 (cut). Scale 1:20
4	Plan	Post-ex plan of Cxt No. 207, Scale 1:20
5	Section	East facing section Cxt No. 205 and Cxt No. 207, Scale 1:10
6	Profile	Profile of cuts Cxt Nos. 207 and 212, Scale 1:10
7	Section	South-east facing section of Cxt. No. 214, Scale 1:20
8	Plan	Post-ex plan of Cxt No. 214, Scale 1:20
9	Plan	Post-ex plan of Cxt Nos. 207 and 212, Scale 1:20
10	Section	East-facing section of baulk, Scale 1:20
11	Section	North-facing section of baulk, Scale 1:20

Appendix Five: Samples register

Sample No.	Context	Description
1	204	Burnt mound material
2	208	Fill of pit Cxt. 212
3	204	Burnt mound material
4	204	Burnt mound material
5	205	Clay fill of pit Cxt. 207
6	210	Burnt mound material
7	213	Fill of pit Cxt. 214
8	215	Fill of pit Cxt. 216
9	208	Fill of pit Cxt. 212



Plate 1: Burnt mound spread (Context No. 204) prior to excavation, looking north.

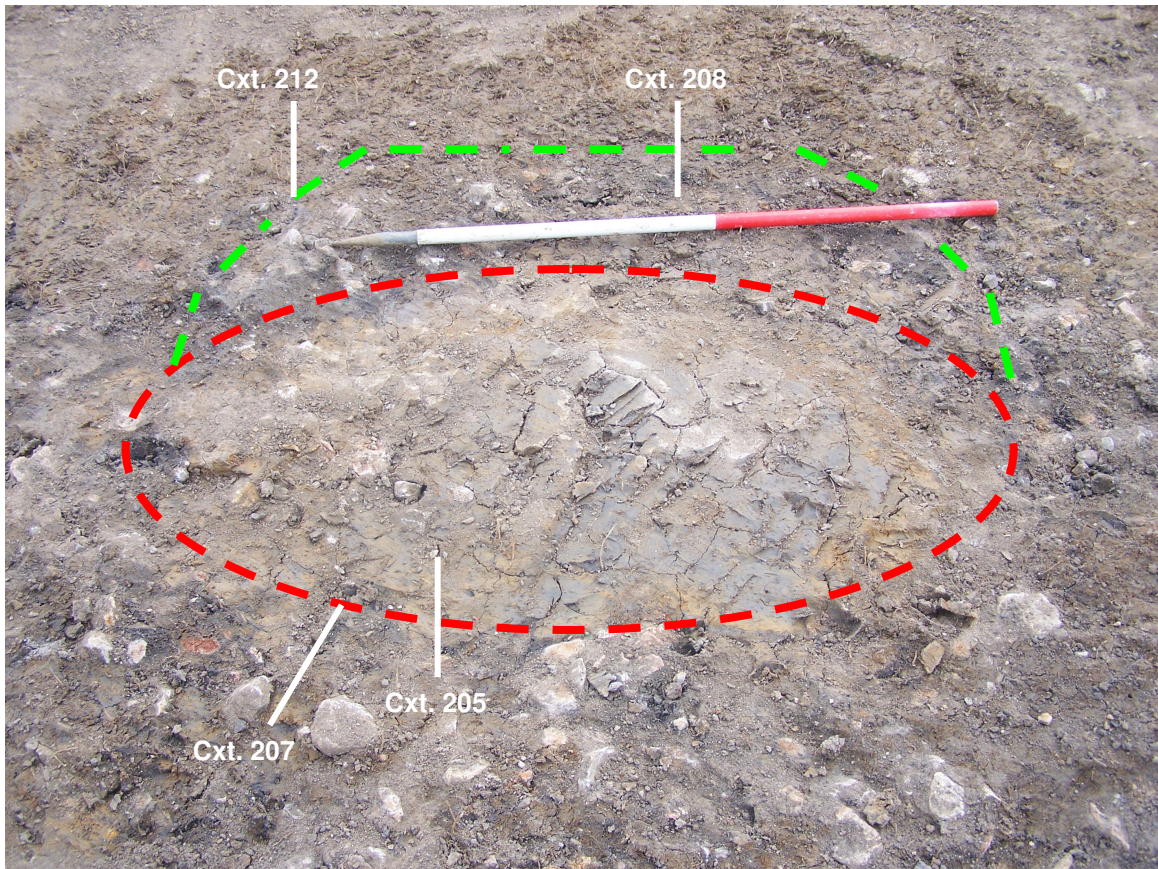

Plate 2: Cuts (Context Nos. 207 and 212) and fills (Context Nos. 205 and 208) prior to excavation, looking east.



Plate 3: Cuts (Context Nos. 207 and 212) following excavation, looking south-east.



Plate 4: Excavation of modern field drain (Context No. 209), looking north-west.



Plate 5: South facing section of pit (Context No. 214).



Plate 6: Pit (Context No. 214) following excavation, looking north.



Plate 7: Burnt sandstone recovered from the lowermost fill (Context No. 213) of pit (Context No. 214).



Plate 8: Rossmacaffry burnt mound showing excavated features, looking north. The field drain (Context No. 209) that cut the burnt mound spread (Context 204) is visible in the foreground. The pit features (Context Nos. 207, 212, 214 and 216) are visible to the middle and upper right of the picture.