



**Evaluation/monitoring Report No. 220**

**Carrickfergus Castle  
Co. Antrim**

**AE/10/202**

| <b>Contents</b>                           | <b>page</b> |
|---|-------------|
| <b>List of Figures</b>                    | <b>3</b>    |
| <b>List of Plates</b>                     | <b>3</b>    |
| <b>Site specific information</b>          | <b>4</b>    |
| <b>Account of the excavation</b>          | <b>5</b>    |
| <b>Discussion</b>                         | <b>8</b>    |
| <b>Recommendations for further work</b>   | <b>10</b>   |
| <b>Acknowledgements</b>                   | <b>10</b>   |
| <b>Archive</b>                            | <b>10</b>   |
| <b>Bibliography</b>                       | <b>11</b>   |
| <b>Appendix 1: Context lists</b>          | <b>17</b>   |
| <b>Appendix 2: Harris matrices</b>        | <b>19</b>   |
| <b>Appendix 3: Concordance table</b>      | <b>20</b>   |
| <b>Appendix 4: Field drawing register</b> | <b>23</b>   |
| <b>Appendix 5: Samples record</b>         | <b>23</b>   |
| <b>Appendix 6: Small finds register</b>   | <b>23</b>   |
| <b>Appendix 7: Photographic record</b>    | <b>24</b>   |

## List of Figures

|   |    |
|---|----|
| Figure 01: Ground floor plan of Carrickfergus Castle              | 5  |
| Figure 02: Recommended post-excavation analysis table             | 10 |
| Figure 03: Plan of Inner Ward, showing excavation trenches        | 12 |
| Figure 04: Trench 1 plan  | 13 |
| Figure 05: Trench 1 west-facing section                           | 13 |
| Figure 06: Trench 2 plan  | 14 |
| Figure 07: Trench 2 west facing section                           | 14 |
| Figure 08: Trench 3 plan  | 15 |
| Figure 09: Trench 3 north-west facing section                     | 15 |
| Figure 10: Stone architectural feature (top, side and base views) | 16 |

## List of Plates

|  |    |
|--|----|
| Plate 01: Trench1, mid-excavation view of brick path C106, looking east      | 25 |
| Plate 02: Trench 1, mid-excavation view of dump of cobbles                   | 25 |
| Plate 03: Trench 1, view of cobbled surface C112, with cut C129 to the right | 26 |
| Plate 04: Trench 2, post-excavation view, looking west                       | 26 |
| Plate 05: Trench 3, post- excavation view of brick wall C305                 | 27 |
| Plate 06: Trench 3, post-excavation view of trench looking south-west        | 27 |
| Plate 07: View of interior of access tunnel, looking north-west              | 28 |
| Plate 08: View of external entrance to access tunnel, looking south-east     | 28 |
| Plate 09: Base of stone architectural feature                                | 29 |
| Plate 10: Side view of stone architectural feature                           | 29 |

### **Site Specific Information**

*Site Address:* Carrickfergus Castle, Carrickfergus, Co. Antrim

*Town:* Carrickfergus

*SMR No.* ANT 052:059

*State Care* √ *Scheduled* *Other*

*Grid Ref:* J 4143 8725

*Excavation Licence No:* AE/10/202

*Planning Ref:* N/A

*Date of excavation:* 5 January 2011 to 10 January 2010

*Archaeologist present:* Dr Henry Welsh

*Brief Summary:*

*Type of evaluation:*

Archaeological monitoring of the excavation and recording of one trench, excavated by hand (Trench 1), along an area known as the Inner Ward, located between the Keep and the south curtain wall and two extensions (Trenches 2 and 3) to connect Trench 1 with the Toilet Block adjacent to the Keep, with the Flash Room Corridor, respectively. The excavation of trenches 2 and 3 required the lifting of a layer of concrete paving blocks and their concrete foundation, by mechanical cutters and chisels, in advance of their subsequent excavation by hand.

*Size of area opened:*

Trench 1: 15.1m (north/south) by 0.3m (east/west)

Trench 2: 2.2m (north/south) by 0.3m (east/west)

Trench 3: 1.85m (north-east/south-west) by 0.3m (south-east/north-west)

## Account of the monitoring

### Introduction

Archaeological monitoring was undertaken on behalf of the Northern Ireland Environment Agency: Built Heritage (NIEA), from 5 January 2011 to 10 January 2011 within the Inner Ward of Carrickfergus Castle. The NIEA was considering bringing the Flash Room and associated corridor into use as a public access area, requiring the provision of lighting, an interpretation panel and a new floor surface. In association with these works, a trench for an electricity supply was required to connect the Flash Room Corridor with an existing supply source within the Keep. The site electrician required this trench to be not less than 0.3m wide and 0.5m deep. As this work would be intrusive, it was agreed that archaeological monitoring of the trench excavation would take place.

During the excavation of the trench by members of staff from the Northern Ireland Environment Agency: Built Heritage and the Centre for Archaeological Fieldwork at Queen's University, Belfast, substantial archaeological remains were uncovered and it was decided to terminate the excavation at around 0.3m-0.4m deep in order to disturb these remains as little as possible.

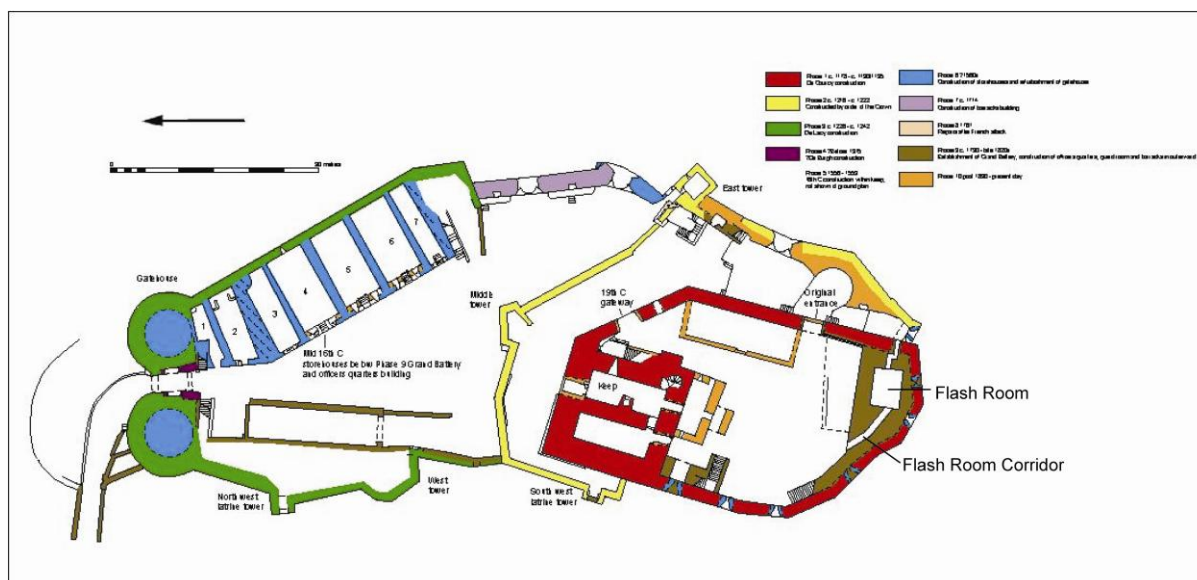

Figure 01: Ground Floor plan of Carrickfergus Castle (after Ó Baoill 2008)

Carrickfergus Castle has been subject to much historical research and archaeological investigation and is possibly most comprehensively described by Dr T. E. McNeill in *Carrickfergus Castle, County Antrim, Northern Ireland Archaeological Monographs: No. 1*, published by the Department of the Environment for Northern Ireland in 1981 and more recently by Ruairí Ó Baoill (2008) in *Carrickfergus, the Story of the Castle and Walled Town*, Belfast NIEA.

The mid-nineteenth century Flash Room Corridor was the subject of an archaeological evaluation in 2008, prior to the commencement of any up-grading work (see Welsh 2010, *Archaeological*

## The excavation

A trench (Trench 1) was excavated north/south across the Inner Ward, to connect the Toilet Block at the south of the Keep to the entrance of the Flash Room Corridor. The trench was 0.3m in width, 15.1m in length and varied from 0.3m to 0.4m in depth, determined by the archaeological remains that were uncovered during the excavation. Extensions to this trench to the north and south (Trenches 2 and 3 respectively) were subsequently requested by NIEA staff to facilitate connection of the electricity supply. The excavations were undertaken by concrete cutter and hand and a context record for the site was created using the standard context recording method. Individual features and deposits were photographed. An overall plan of the immediate area (scale 1:100) was completed and plan and section drawings (scales 1:20 and 1:10 respectively) were prepared throughout the course of the investigation.

### Trench 1

Trench 1 was excavated across the grassed area of the Inner Ward, 15.1m in length and aligned north/south. The stratigraphically latest deposit encountered consisted of a turf layer (Context No. 101) which was 0.05m in depth and extended across the entire area of the trench. Immediately beneath this was a gravel-rich loamy layer (Context No. 102), which also extended across the entire area of the trench. This was interpreted as a modern levelling deposit, to create a level substrate for the turf layer. The presence of a wide range of artefacts in this context from many time periods suggested this material was obtained from a variety of sources around the castle and perhaps further afield. At the northern end of Trench 1, a modern perforated plastic drainage pipe was found (Context No. 114), extending across the trench in an east/west alignment. A similar pipe was observed to discharge into the tunnel that is located underneath the western part of the Inner Ward and represents a modern effort to improve drainage in this part of the castle.

A variety of features were found immediately below Context No. 102. The first of these (Context No. 108) was located between 2.1m and 2.8m from the northern end of the trench. This was a deposit of compacted mortar-rich sandy loam, around a dump of cobble stones, many of which had mortar attached to them. To the south of this, was a layer of orange sand (Context No. 109), averaging 0.05m in depth. This was found to terminate at another deposit of compacted mortar-rich sandy loam (Context No. 110), within which was a deposit of larger rounded stones (approximately 0.02m in diameter). When context No. 109 was removed, it was found to be 0.05m in depth. No finds were recovered from this context. Immediately below Context No. 109, a layer of mortar-rich gravelly loam was present (Context No. 113). This was excavated to a depth of 0.4m at which point the limit of excavation was reached. One piece of bone and a metal object, possibly an iron nail, were recovered. All the deposits and finds in this area were consistent with the excavation, construction and filling in around the brick-built tramway tunnel in the Inner Ward constructed in 1889 (McNeill 1981, 51).

To the south of this, at 6.1m from the northern end of the trench, a concrete slab (Context No. 116) was encountered at the eastern side of the trench. This was associated with the tunnel described above and formed the support for the manhole cover which leads from the ground surface in the Inner Ward, to the tunnel itself. The concrete slab extended for 1.2m towards the southern end of Trench 1 and was aligned north-east/south-west. To the west of the trench and on a similar alignment to the concrete slab, a mortared brick surface was uncovered (Context No. 121). This was probably associated with the brick-built tunnel, located immediately below. To the south of the concrete slab, a deposit of gravel and clinker-rich sandy clay was uncovered (Context No. 107), which extended for 1.7m, where it abutted a cobbled surface (Context No. 112). The only finds in this area were three pieces of shell, found in Context No. 107.

The cobbled surface (Context No. 112) had been cut (Cut No. 129), probably during the construction of the tramway tunnel described above and this point marks the southernmost extent of the disturbance of the Inner Ward associated with these works. The presence immediately above the cobbled surface of cinder-rich (Context No. 126) and mortar-rich (Context No. 127) deposits, similar to Context No. 113 to the south, suggests the cobbled surface was exposed while construction and restoration works connected with the tramway tunnel were taking place. Other features in the remainder of Trench 1 were found to be undisturbed. The original requirement was that the trench be excavated to a depth of 0.5m in order to accommodate a plastic duct for the provision of the electricity supply to the Flash Room Corridor. Due to the presence of these undisturbed archaeological features and in consultation with staff at the castle and Mr Andrew Gault, Inspector at the Northern Ireland Environment Agency: Built Heritage, it was agreed to limit the depth of the excavation at the point where there would be still sufficient depth to accommodate the duct, at around 0.2m to 0.3m.

The cobbled surface (Context No. 112) was found to extend at least 4m to the south, with a variety of features placed on it at intervals. The first of these was an un-mortared brick surface (Context No. 106), consisting of eight visible bricks, which extended into the eastern side of the trench. The southern-most of these bricks was found to rest on a deposit of mortar (Context No. 120), which extended across the trench and for 0.4m to the south. This was interpreted as being either a path aligned east/west, or a platform to support the crane associated with raising ammunition and supplies from the tramway tunnel nearby. The restricted size of Trench 1 prevented a more positive identification.

To the south of this brick feature three small areas of mortared stonework (Context No. 118) were uncovered, along with a small mortar-rich surface (Context No. 117). Due to the restricted size of the trench, it was not possible to determine if these were separate features or all part of a larger structure, but their proximity and similar constructional components suggest these were all part of one feature, perhaps wall foundations. This may be the partial remains of the south wall of the building marked *Engine House* on the 1811 map of the Castle (PRO wo 78/1158, cited in McNeill 1981). The only other feature uncovered in this area was a small mortared brick wall (Context No. 103), which consisted of a single row of broken bricks, aligned east/west and which continued across the trench. This was located at the southern end of the trench and probably represented the remains of a small landscaping feature. It was in this area that a moulded stone architectural feature (Small Find No. 1; see Figure 10 and Plates 09 and 10) was uncovered within Context No. 104 and close to Context No. 103. An initial examination of this object was carried out by Dr Tom McNeill,

who concluded (pers. comm.) that it seemed to be similar to four similar stone objects, previously found during work in this area to lay paths around the Inner Ward. He suggested that these might be surviving parts of a post-medieval fireplace that was removed from the Keep.

### Trench 2

Trench 2 was 2.1m in length, aligned north/south and located to the north of Trench 1. It was effectively an extension of Trench 1, being required to connect the existing electricity supply from a source in the keep to the northern end of Trench 1. The stratigraphically latest deposit encountered was a layer of concrete paving blocks (Context No. 201). Immediately below this was a concrete substrate (Context No. 202), along which a trench 0.3m wide had to be cut using an angle grinder. Under this was a concrete foundation layer (Context No. 203), which also had to be cut with an angle grinder before removal by hand. Under this was a clinker and mortar-rich deposit, which was excavated to a depth of 0.4m. Also uncovered were concrete edging (Context No. 206) and an associated concrete foundation (Context No. 205). Nothing of archaeological significance was found in this trench and deposits were consistent with modern disturbance associated with the construction of paving around the Inner Ward.

### Trench 3

Trench 3 was 1.85m in length, aligned north-east/south-west and located to the south of Trench 1, being required to connect the new electricity supply from the southern end of Trench 1 to the Flash Room Corridor. The stratigraphically latest deposit encountered was a concrete door sill (Context No. 301) at the entrance of the Flash Room Corridor. This abutted a layer of concrete paving blocks (Context No. 302). Immediately below this was a concrete substrate (Context No. 303), along which a trench 0.3m wide had to be cut using an angle grinder. Immediately under Context No. 302 was a deposit of mortar-rich gravelly clay (Context No. 307), which had been cut (Cut No. 309) to permit the construction of a mortared brick wall (Context No. 305), 0.3m in width, aligned east/west across the trench. A dark grey gravel-rich clay had later been deposited around the brick wall, probably as part of preparatory levelling in connection with construction of the modern paving. Context No 307 had also been cut (Cut No. 310) to permit the construction of the concrete edging (Context No. 306). A levelling deposit (Context No. 308) had then been added in order to provide a foundation for the concrete substrate (Context No. 303) referred to above. No finds were recovered from this trench. The limited area of Trench 3 militated against a positive interpretation of the brick wall Context No. 305, but its mortared construction and regular shape suggests it was more substantial than a garden feature and may represent the remains of a small building, perhaps associated with the nearby Flash Room to the east.

## **Discussion**

The excavation of a trench across the Inner Ward of Carrickfergus Castle provided a rare opportunity to see if undisturbed archaeological remains survived in this area, one of the oldest parts of the Anglo-Norman castle. Following small-scale excavations by Professor Jope in the 1950s and Nick Brannon in 1993 (Ó'Néill 2002, 3), it was thought that nothing of any antiquity survived in the Inner Ward due to the disturbance caused by regular building works at the castle, particularly during the nineteenth century when the tramway tunnel was constructed in the western part of the Inner Ward.



However, the 2011 excavation has revealed that while the north-western part of the Inner Ward has indeed suffered major disturbance, many archaeological features still remain to be investigated in the southern part. The limited size of the trenches and time constraints during the 2011 excavation prevented meaningful interpretation of the features uncovered, but initial examination of the finds suggests that the material above the cobbled surface is reasonably modern and the possibility remains that medieval remains still lie undisturbed beneath it.

Following the conventions used by McNeill to denote periods of time at Carrickfergus Castle (1981, 19), there are possibly three periods relevant to the archaeological remains uncovered during this excavation. These are Periods VIII, IX and X.

#### Period VIII [1754-1792]

According to McSkimin (1823, 164), part of the south curtain wall of the castle collapsed in 1754, facilitating the French occupation in 1760 and repairs probably took place in 1761. There is a possibility that the cobbled surface (Context No. 112) may be associated with this repair work, providing a solid surface to the repaired Inner Ward.

#### Period IX [1793-1854]

Construction work in the Inner Ward of the castle during this period is discussed by McNeill (1981, 49). A number of buildings 'were recorded by McSkimin as being built or rebuilt in the castle between 1793 and the winding-down of the castle as an active base between 1816, when it ceased to be an infantry barrack, to the 1830s when almost all the garrison was withdrawn'. With regard to buildings within the southern part of the inner ward, 'other buildings which McSkimin says were built in this period were...a small magazine in the inner ward'. This magazine must have served the guns of the grand battery on the eastern side of the castle, as 'the guns now lining the grand battery bear dates around 1800 and the present embrasures and height of the curtain probably date from this period...the new artillery demanded the building of the magazine which now fills the southern end of the inner ward'. This small brick-built magazine was probably the room now known as the Flash Room and the brick walls found at the southern end of Trench 1 (Context No. 103) and in Trench 2 (Context No. 305) may have been associated with work at this magazine.

#### Period X [1855-1889]

The castle 'was put back into commission as the headquarters of the Antrim Artillery in 1855, which caused a programme of rebuilding to take place, normally using hammer-dressed granite and modern three-inch pressed bricks' (McNeill 1981, 50). These are the materials used extensively in the construction of the Flash Room Corridor and external wall facings. These works also included 'a new magazine, or armourer's shop, built against the south side of the keep' and 'the two embrasures reached by the long stair at the west side of the ward, all in hammer-dressed granite, were built over the magazine at the south at this time. This new magazine is still present, although now used as public toilets and was the location for an archaeological excavation in 2002 (see Ó Néill, J. and Logue, R. 2002. *Data Structure Report No 8, Investigations at Carrickfergus Castle, Co. Antrim*).

The northern side of the Flash Room Corridor, facing the Keep, is faced with hammer-dressed granite blocks and is brought level with the top of the south curtain wall to provide a solid platform for two gun embrasures that are still evident today. In front of this structure was a single storey

building 'now removed except for its north wall whose foundations survive; in 1923 this was the armourer's shop' (McNeill 1981, 51). Wall scars on the northern face also confirm the location of this building. The mortared stone features found at the southern end of Trench 1 (Context Nos 117 and 118) may be associated with the construction of this building, but there is a problem in that the length of mortared stone wall that is visible in the Inner Ward is not parallel with the hammer-dressed Granite wall of the Flash Room building. The wall is 4.2m distant at the eastern end and 3.4m distant at the western end, a significant discrepancy (0.8m) and one which calls into question its function as the north wall of the armourer's shop.

### Recommendations for further work

This archaeological monitoring has shown that there are significant archaeological remains in the Inner Ward, despite the significant disturbance of nineteenth and twentieth-century works. These remains were uncovered at a depth of 0.3m below ground surface at the southern part of the trench. The discovery of in-situ archaeological features contrasts with previous archaeological investigations in the Inner Ward by Professor Martyn Jope in 1950 and Nick Brannon in 1980, when nothing archaeological was found, suggesting these excavations were located in the northern part of the Inner Ward. The presence of undisturbed archaeological remains in the Inner Ward presents an opportunity to learn more about the early life of the castle from any future excavation in this area.

It is recommended that post-excavation analysis should be carried out on the finds recovered during the excavation. This could be carried out internally at the Centre for Archaeological Fieldwork, without additional cost implications, as follows:

| Material            | Number of items | CAF Specialist      | Time implication |
|---------------------|-----------------|---------------------|------------------|
| Bone/Shell          | 23              | Dr Emily Murray     | 1 day            |
| Flint               | 47              | Brian Sloan         | 2 days           |
| Pottery/Glass/Stone | 37/28/2         | Ruairí Ó Baoill     | 2 days           |
| Metal               | 5               | Dr Philip MacDonald | 1 day            |

Figure 02: Recommended post-excavation analysis table

### Acknowledgements

Assistance during the course of the excavation was kindly provided by June Welsh and Ian Gillespie of the Ulster Archaeological Society and the Northern Ireland Environment Agency staff at Carrickfergus Castle. The field drawings were scanned and prepared by Sapphire Mussen at the Centre for Archaeological Fieldwork, Queen's University, Belfast.

### Archive

*Finds:* All finds are currently archived at the Centre for Archaeological Fieldwork, Queen's University Belfast, but it is anticipated these will be returned to the Northern Ireland Environment Agency following any post-excavation analysis.

*Photographs:* digital images, held by the Centre for Archaeological Fieldwork, Queen's University Belfast.

*Plans/Drawings*: digital plans and section drawings, held by the Centre for Archaeological Fieldwork, Queen's University Belfast and included with this report.

## **Bibliography**

McNeill, T.E. 1981. *Carrickfergus Castle, County Antrim, Northern Ireland Archaeological Monographs: No. 1*, Belfast: HMSO.

McSkimin, S. 1811. *The history and antiquities of the county of the town of Carrickfergus*, Belfast.

Ó Baoill, R. 2008. *Carrickfergus, the Story of the Castle and Walled Town*. Belfast: Northern Ireland Environment Agency.

Ó Néill, J. and Logue, R. 2002. *Data Structure Report No. 8, Investigations at Carrickfergus Castle, Co. Antrim*. Belfast: Queen's University, Centre for Archaeological Fieldwork.

Welsh, H. 2010. *Evaluation/Monitoring Report No. 169, Carrickfergus Castle, County Antrim*. Belfast: Queen's University, Centre for Archaeological Fieldwork.

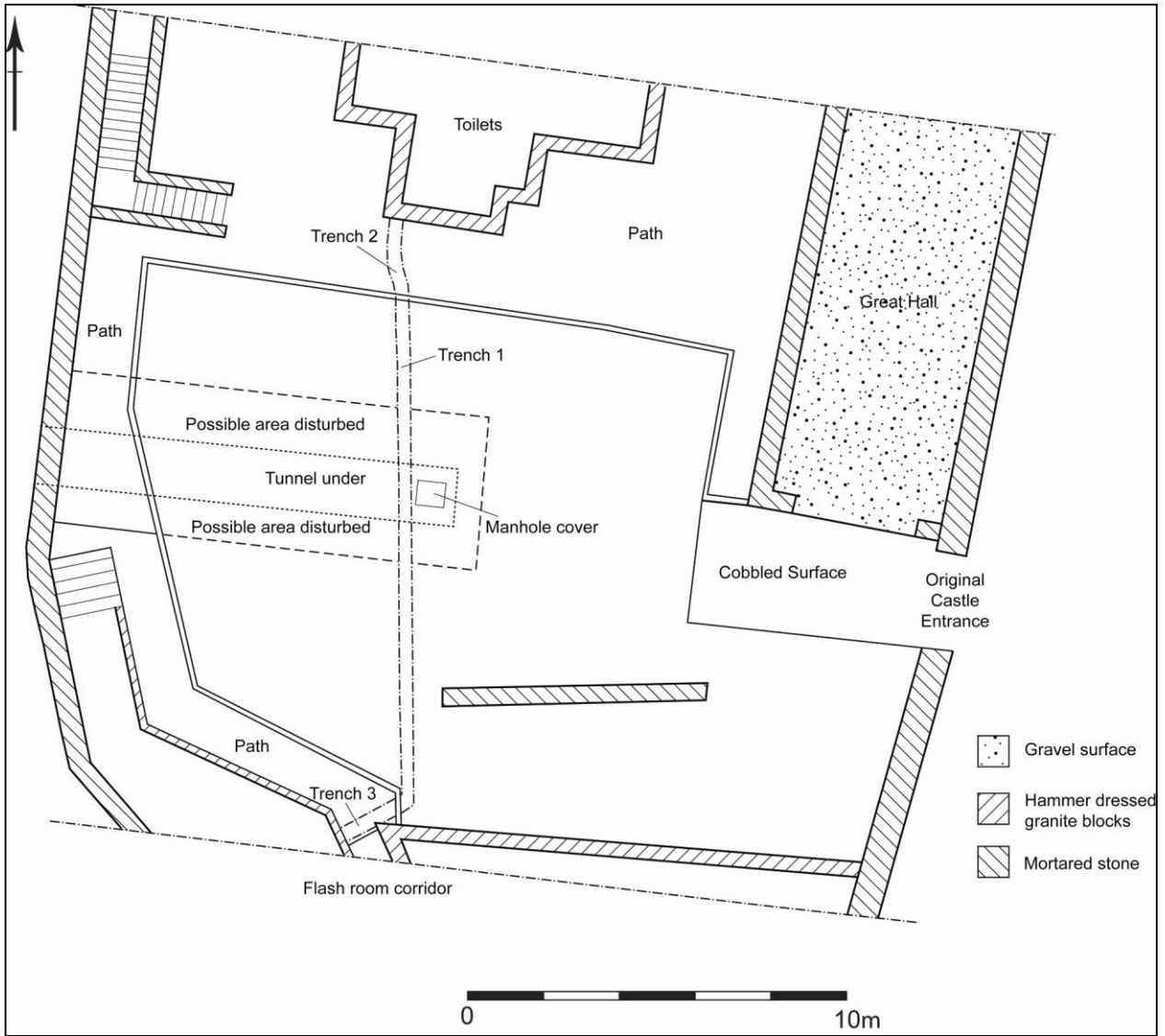

Figure 03: Plan of Inner Ward, showing excavation trenches

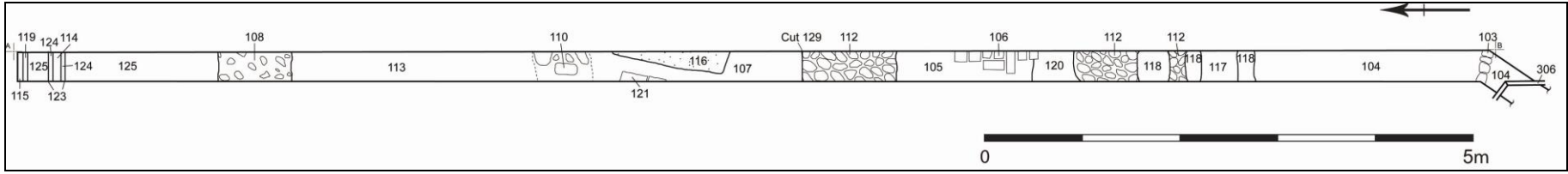

Figure 04: Trench 1 plan

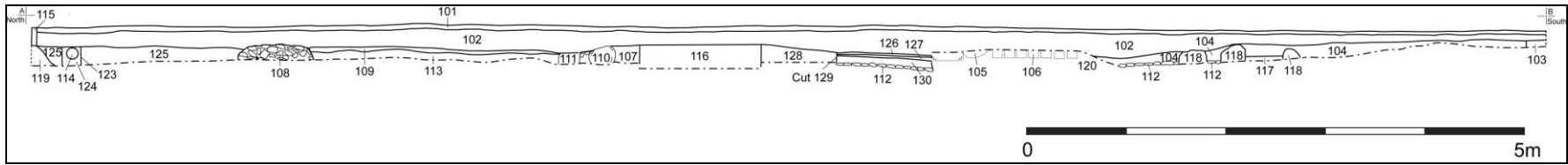

Figure 05: Trench 1 west-facing section

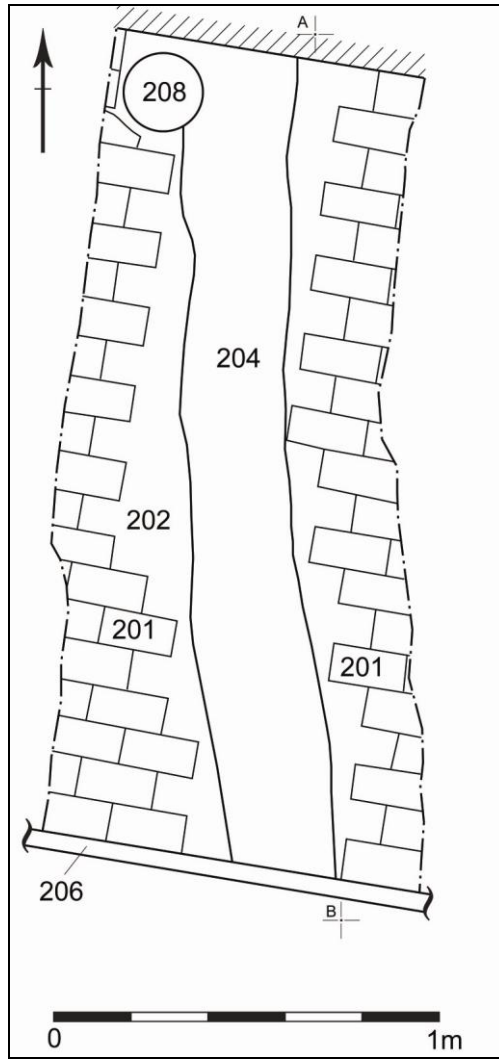

Figure 06: Trench 2 plan

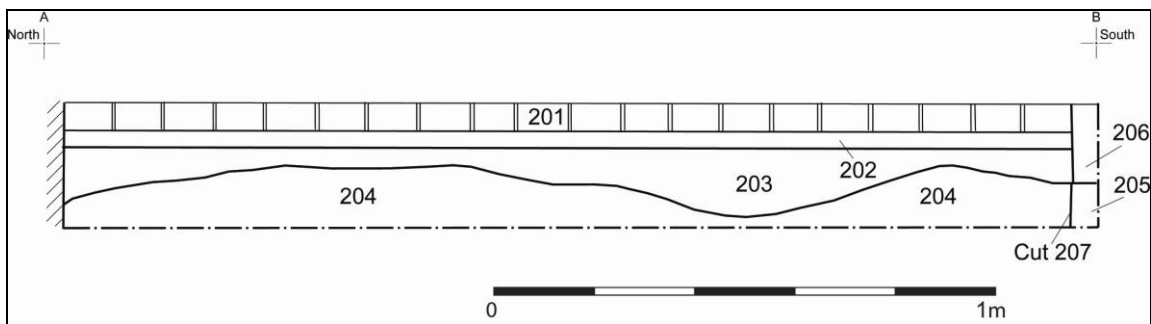

Figure 07: Trench 2 west-facing section

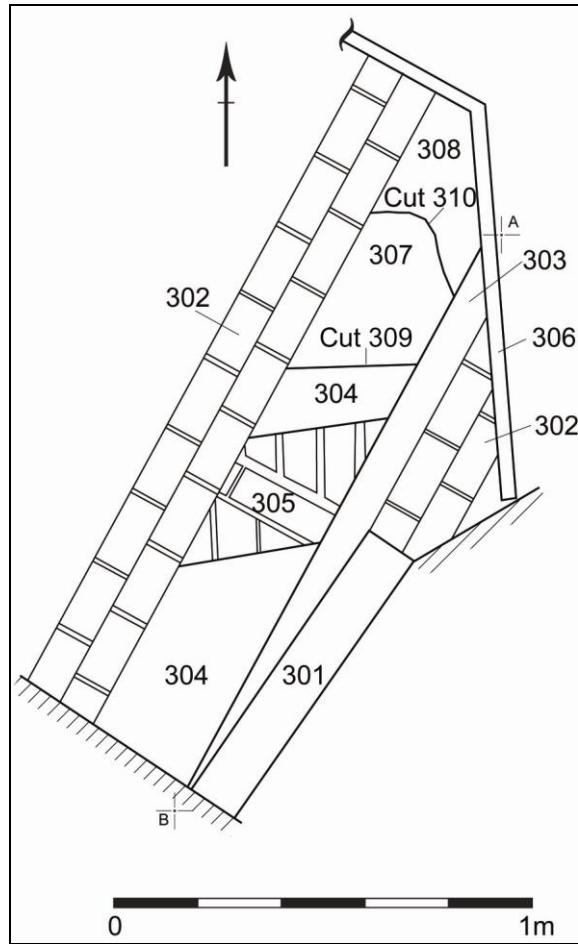

Figure 08: Trench 3 plan

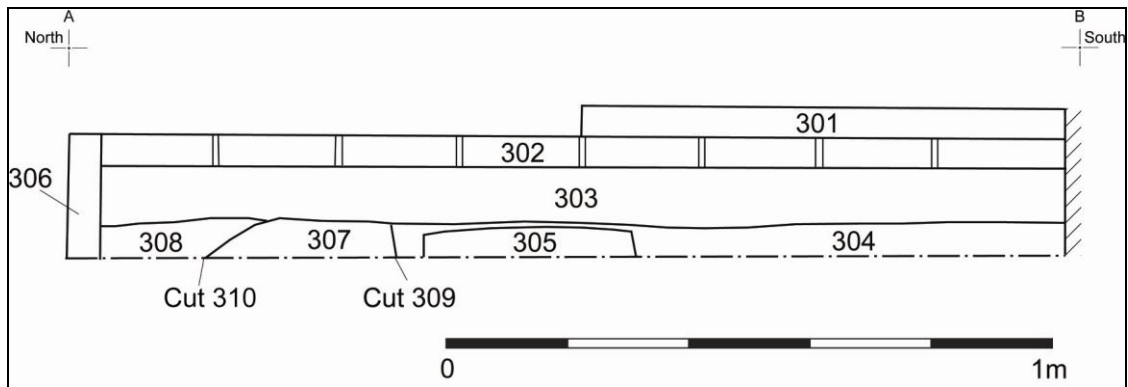

Figure 09: Trench 3 north-west facing section

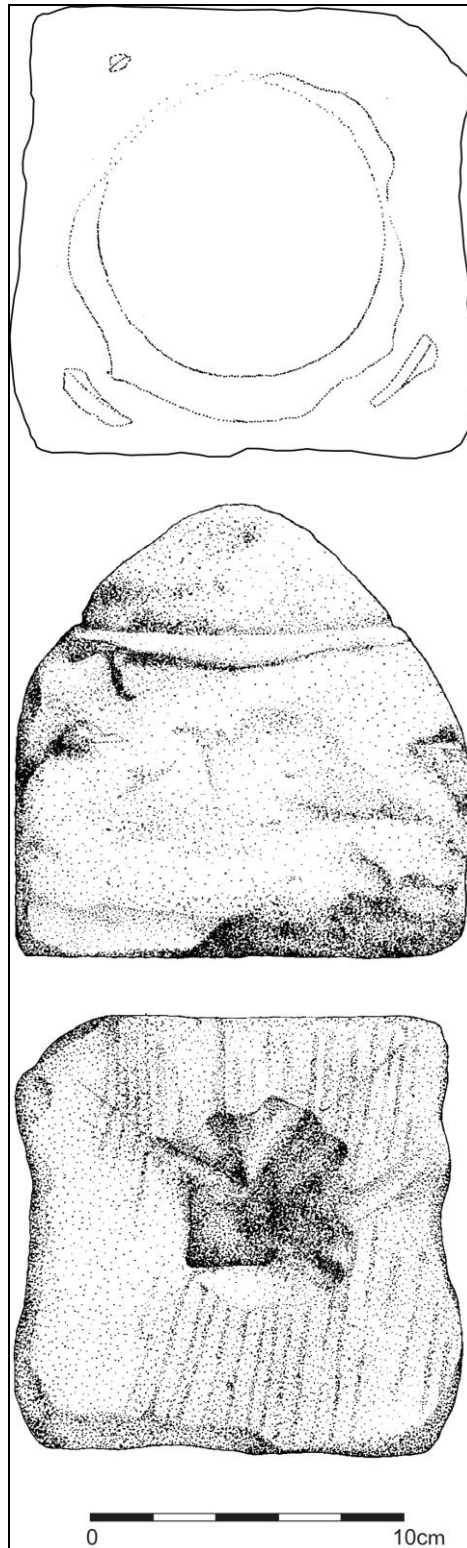

Figure 10: Stone architectural feature (top, side and base views)



## Appendix 1: Context Lists

### Trench 1

| Context No. | Description   |
|-------------|---|
| 101         | Turf Layer  |
| 102         | Gravel-rich levelling deposit                                       |
| 103         | Small mortared brick feature at south (Flash Room end) of trench    |
| 104         | Rubble-rich fill to north of brick feature C103                     |
| 105         | Clinker-rich fill north of C106                                     |
| 106         | Large un-mortared brick setting                                     |
| 107         | Clinker-rich fill north of C105                                     |
| 108         | Compacted dump of brick and cobbles                                 |
| 109         | Orange sandy layer between C108 and C112                            |
| 110         | Un-mortared stone wall?   |
| 111         | Rubble fill north of C110   |
| 112         | Cobbled surface under C111  |
| 113         | Mortar-rich deposit under C109                                      |
| 114         | Plastic drainage pipe   |
| 115         | Concrete edging   |
| 116         | Concrete base for manhole cover C122                                |
| 117         | Mortar-rich surface   |
| 118         | Mortared stonework  |
| 119         | Concrete foundation for C115  |
| 120         | Un-mortared stone feature   |
| 121         | Brick feature adjacent to C116                                      |
| 122         | Steel manhole cover   |
| 123         | Cut for plastic pipe C114   |
| 124         | Dark brown fill around plastic pipe C114                            |
| 125         | Rubble-rich fill under C102 at north of trench                      |
| 126         | Cinder-rich deposit immediately above C127 and cobbled surface C112 |
| 127         | Mortar-rich deposit immediately above C128 cobbled surface C112     |
| 128         | Gravelly-sand layer between C116 and C129                           |
| 129         | Cut for tunnel  |
| 130         | Gravel-rich sandy deposit over cobbled surface C112                 |

### Trench 2

| Context No. | Description                             |
|-------------|---|
| 201         | Concrete paving blocks                  |
| 202         | Concrete substrate for C201             |
| 203         | Concrete foundation for C202 AND C201   |
| 204         | Clinker and mortar rich layer           |
| 205         | Concrete foundation for concrete edging |
| 206         | Concrete edging                         |
| 207         | Cut for concrete foundation C205        |
| 208         | Plastic drain water pipe                |

### Trench 3

| <b>Context No.</b> | <b>Description</b>                               |
|--------------------|--|
| 301                | Concrete sill at entrance to Flash Room Corridor |
| 302                | Concrete paving blocks                           |
| 303                | Concrete foundation for C302                     |
| 304                | Mortar-rich gravelly clay layer                  |
| 305                | Mortared brick wall                              |
| 306                | Concrete edging                                  |
| 307                | Earliest deposit of light grey gravelly sand     |
| 308                | Fill of trench for concrete edging               |
| 309                | Cut for brick wall C305                          |
| 310                | Cut for trench for concrete edging C306          |

**Appendix 2: Harris matrices**  
**Trench 1**

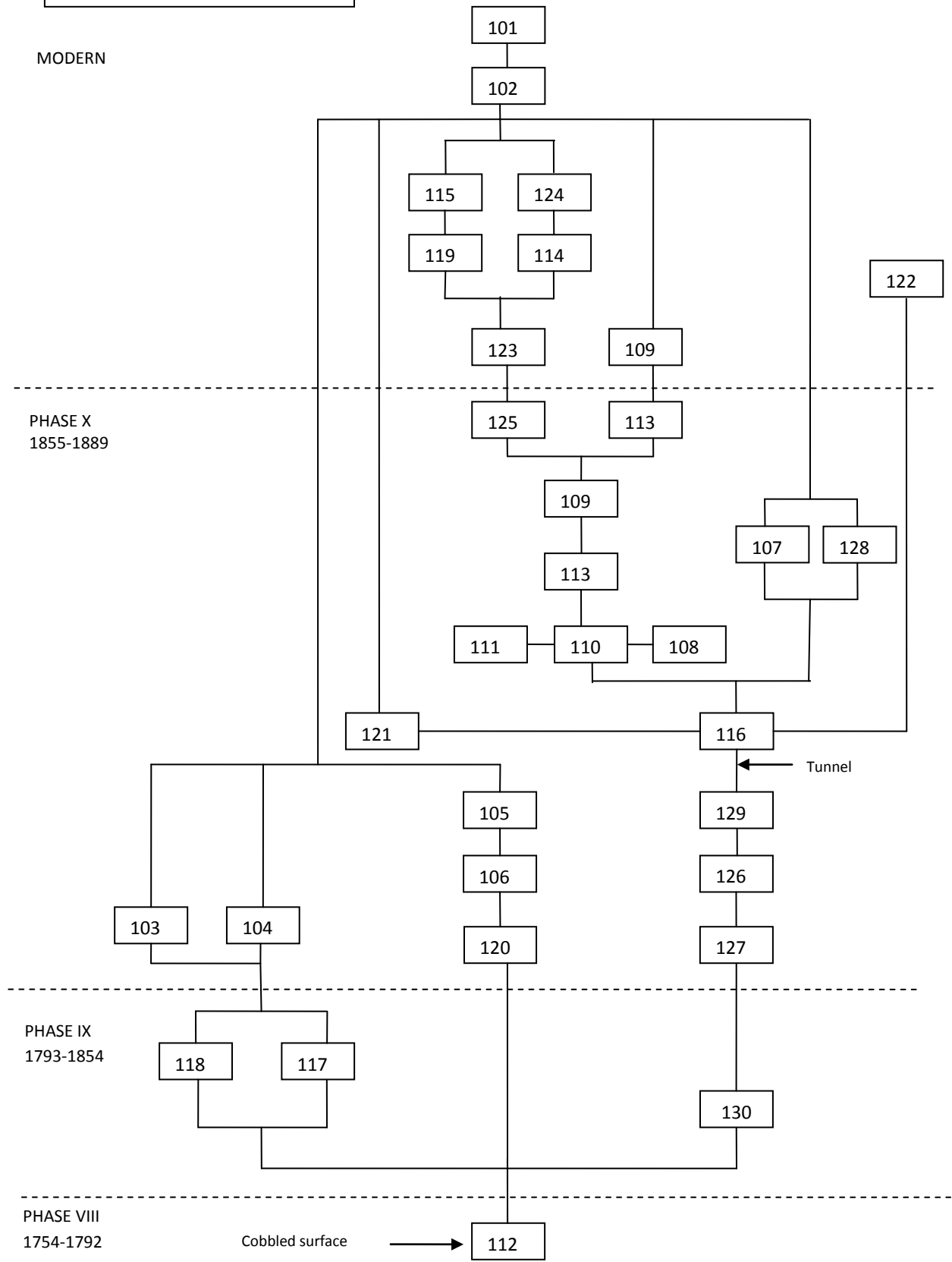

**Harris matrix**  
**Trench 2**

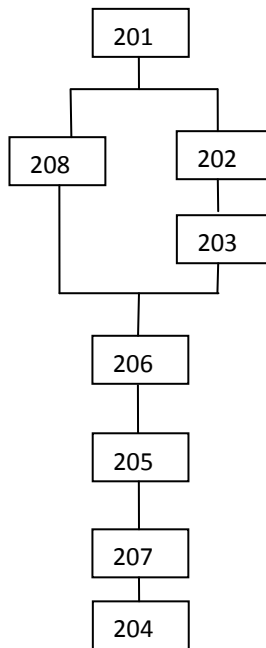

MODERN

**Harris matrix  
Trench 3**

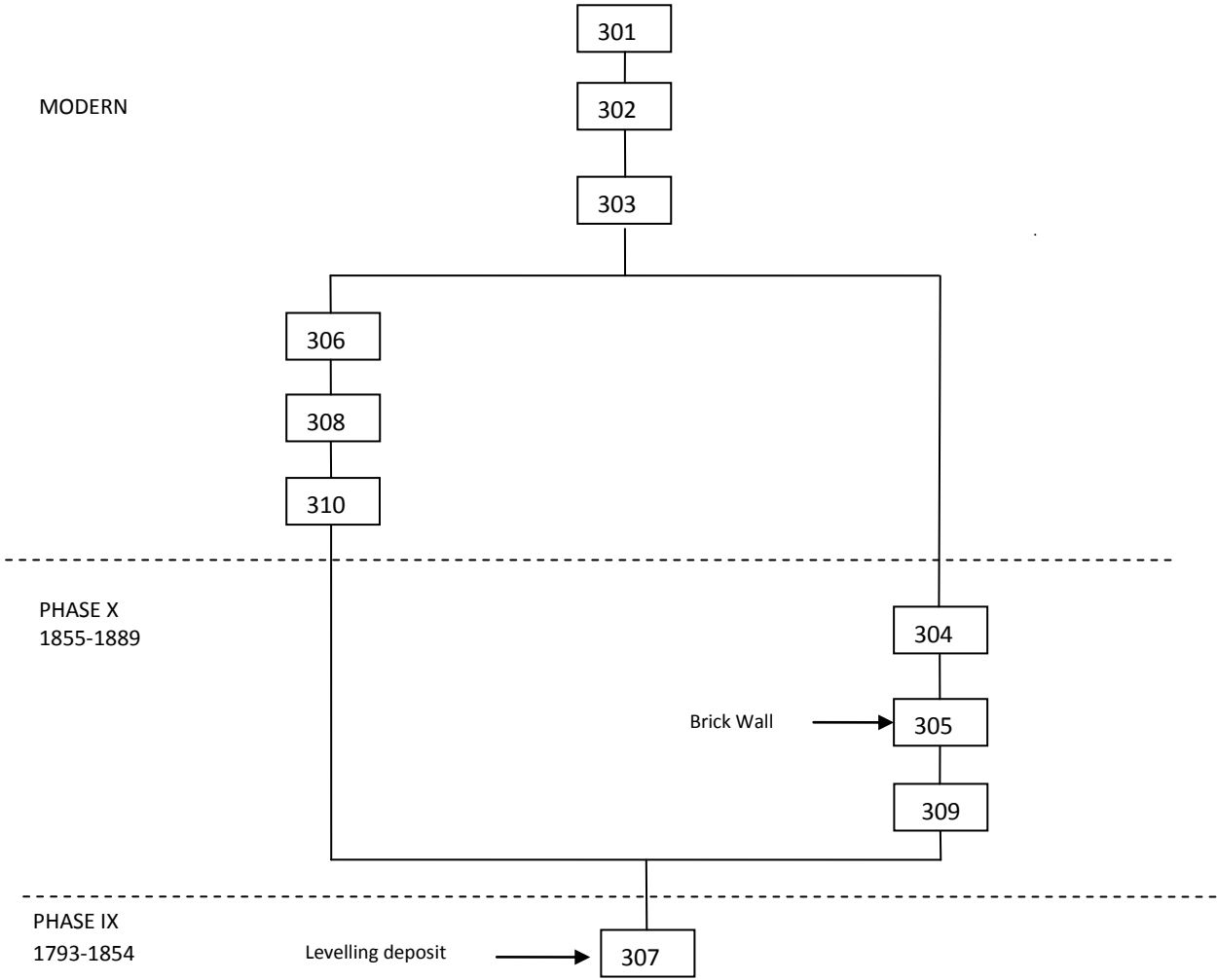

### Appendix 3: Harris Matrix – Concordance Table

| Phase                   | Context  | Trench 1    | Trench 2               | Trench 3    |
|-------------------------|--|-------------|------------------------|-------------|
| Modern                  | Concrete sill                                  |             |                        | 301         |
|                         | Lawn and preparation deposits                  | 101/102     |                        |             |
|                         | Drainage features                              | 114/123/124 | 208                    |             |
|                         | Paving and edge                                | 115/119     | 201/206                | 302/306/308 |
|                         | Paving foundations                             |             | 202/203/205/207<br>204 | 303/310     |
| Phase X<br>1855-1889    | Phase X - Levelling deposits                   |             |                        | 304         |
|                         | Tunnel – associated features                   | 121         |                        |             |
|                         | Constructional elements of Tunnel              | 116/122     |                        |             |
|                         | Spoil from Tunnel excavation                   | 126         |                        |             |
|                         | Cut for Tunnel                                 | 129         |                        |             |
|                         | Deposits above cobbled surface and brick walls | 127/128     |                        |             |
|                         | Brick walls/features                           | 103         |                        | 309/305     |
| Phase IX<br>1793-1854   | Post-demolition levelling deposits             | 130         |                        | 307         |
|                         | Mortar-rich surface                            | 117         |                        |             |
|                         | Mortared stonework                             | 118         |                        |             |
| Phase VIII<br>1754-1792 | Cobbled surface                                | 112         |                        |             |

#### Appendix 4: Field Drawing Register

| Drawing No. | Scale | Type    | Date    | Description                           |
|-------------|-------|---------|---------|---------------------------------------|
| 1           | 1:100 | Plan    | 7/1/11  | Inner Ward including Trench 1         |
| 2           | 1:20  | Plan    | 12/1/11 | Trench 1 and extension                |
| 3           | 1:10  | Section | 10/1/11 | West-facing section of Trench 1       |
| 4           | 1:10  | Section | 11/1/11 | West-facing section of Trench 2       |
| 5           | 1:10  | Section | 12/1/11 | North-east facing section of Trench 3 |
| 6           | 1:20  | Plan    | 12/1/11 | Plan of Trench 2                      |
| 7           | 1:20  | Plan    | 12/1/11 | Plan of Trench 3                      |

#### Appendix 5: Samples Record

| Sample Number | Sample Material | Context | Number of bags |
|---------------|-----------------|---------|----------------|
| 1             | Soil            | 102     | 1              |
| 2             | Cobbles         | 112     | 1              |
| 3             | Brick           | 106     | 1              |
| 4             | Soil            | 109     | 1              |
| 5             | Soil            | 107     | 1              |

#### Appendix 6: Small Finds Register

| Find Number | Material       | Description              | Context Number | Material Category |
|-------------|----------------|--------------------------|----------------|-------------------|
| 1           | Sandstone      | Architectural feature    | 102            | Stone             |
| 2-4         | Flint          | Bag of 3 pieces          | 102            | Stone             |
| 5-6         | Shell          | Bag of 2 pieces          | 102            | Shell             |
| 7-10        | Coal           | Bag of 4 pieces          | 102            | Stone             |
| 11-26       | Bone           | Bag of 16 pieces         | 102            | Bone              |
| 27          | Bone           | 1 piece                  | 113            | Bone              |
| 28          | Shell          | 1 piece                  | 106            | Shell             |
| 29-30       | Flint          | Bag of 2 pieces          | 106            | Stone             |
| 31-33       | Shell          | Bag of 3 pieces          | 107            | Shell             |
| 34-40       | Flint          | Bag of 7 pieces          | 106            | Stone             |
| 41          | Metal          | Nail?                    | 113            | Metal             |
| 42          | Pottery        | 1 sherd                  | 110            | Ceramic           |
| 43-46       | Pottery        | Bag of 4 sherds          | 106            | Ceramic           |
| 47-50       | Metal          | Bag of 4 items           | 102            | Metal             |
| 51          | Red mineral?   | 1 piece                  | 102            | Unknown           |
| 52          | Asbestos tile? | 1 fragment               | 102            | Ceramic           |
| 53          | Limestone      | 1 fragment               | 102            | Stone             |
| 54          | Concrete       | 1 Piece of floor surface | 102            | Stone             |
| 55-82       | Glass          | Bag of 28 fragments      | 102            | Ceramic           |
| 83-114      | Pottery        | Bag of 32 sherds         | 102            | Ceramic           |
| 115-149     | Flint          | Bag of 35 pieces         | 102            | Ceramic           |

## Appendix 7 Photographic Record

*Ricoh Caplio 500 G wide, 8 Megapixel*

| Reference | Details  |
|-----------|--|
| RIMG0008  | Trench 1: mid-excavation view of brick path C106, looking east   |
| RIMG0014  | Trench 1: mid-excavation view of small brick wall C103, looking east   |
| RIMG0021  | Trench 1: mid-excavation view of stone feature C110, looking east  |
| RIMG0042  | Trench 1: mid-excavation view of dump of cobbles C108  |
| RIMG0107  | Trench 1: modern plastic drainage pipe C114, looking west  |
| RIMG0116  | Trench 1: post-excavation view of rubble-rich fill C104, looking north-east                                  |
| RIMG0080  | Trench 1: view of cobbled surface C112, with cut C129 to the right   |
| RIMG0051  | Trench 1: mid-excavation view, with manhole cover to access tunnel and part of associated concrete base C116 |
| RIMG0100  | Trench 2: post-excavation view, looking west   |
| RIMG0101  | Trench 2: post-excavation view, looking east   |
| RIMG0106  | Trench 2: connection between Trenches 1&2, with concrete edging left in place, looking south                 |
| RIMG0076  | Trench 3: post-excavation view of brick wall C305  |
| RIMG0114  | Trench 3: mid-excavation view of duct into Flash Room Corridor, looking east                                 |
| RIMG0115  | Trench 3: Mid-excavation view of connection with Trench 1, looking north-east                                |
| RIMG0077  | Trench 3: post-excavation view of trench, looking south-west   |
| RIMG0059  | Post-excavation view of Inner Ward and excavation, looking east  |
| RIMG0058  | Post-excavation view of excavation, with connection to Toilet Block, looking south-east                      |
| RIMG0093  | View of external entrance to access tunnel, looking south-east   |
| RIMG0034  | View of interior of access tunnel, looking north-west  |





Plate 01: Trench 1: mid-excitation view of brick path C106, looking east



Plate 02: Trench 1: mid-excitation view of dump of cobbles C108



Plate 03: Trench 1: view of cobbled surface C112, with cut C129 to the right



Plate 04: Trench 2: post-excavation view, looking west



Plate 05: Trench 3: post-excitation view of brick wall C305



Plate 06: Trench 3: post-excitation view of trench, looking south-west



Plate 07: View of interior of access tunnel, looking north-west



Plate 08: View of external entrance to access tunnel, looking south-east



Plate 09: Base of stone architectural feature

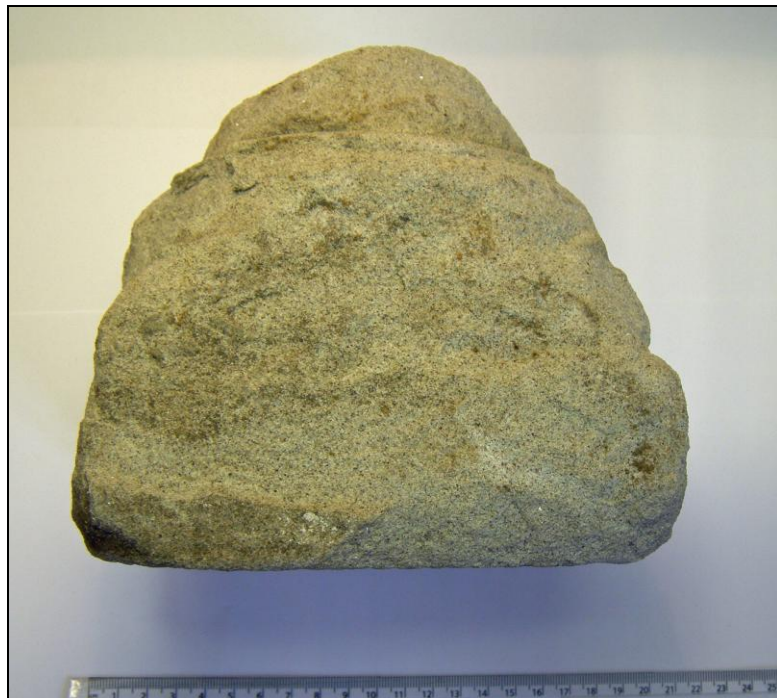

Plate 10: Side view of stone architectural feature



Plate 11; View of possible limewash residue on stone feature