

**The Centre for Archaeological Fieldwork,**  
School of Geography, Archaeology and Palaeoecology,  
Queen's University, Belfast



**CAF Data Structure Report No. 108**

AE/14/170

**Excavations at Grey Point Fort,**

**Co. Down**

DHP No. 315

*March 2015*

On behalf of





## **Excavations at Grey Point Fort, Co. Down**

Excavations carried out on behalf of  
The Northern Ireland Environment Agency: Built Heritage

by

The Centre for Archaeological Fieldwork,  
School of Geography, Archaeology and Palaeoecology,  
Queen's University,  
Belfast.  
BT7 1NN

*Ruairí Ó Baoill and Heather Montgomery*  
CAF DSR 108

DHP No. 315  
Grid Ref: J 45698 83254  
Excavation Licence: AE/14/170

*March 2015*

## Contents

List of Figures

List of Plates

List of Tables

<b>1 Summary</b>	<b>1</b>
<b>2 Introduction and background</b>	<b>1</b>
<b>2.1 General</b>	<b>1</b>
<b>2.2 Historical background</b>	<b>2</b>
<b>2.3 Grey Point Fort today</b>	<b>11</b>
<b>2.4 Archaeological Background</b>	<b>12</b>
<b>3 The 2014 excavation</b>	<b>15</b>
<b>3.1 Circumstances of the Excavation</b>	<b>15</b>
<b>3.2 Methodology</b>	<b>15</b>
<b>3.2.1 General</b>	<b>15</b>
<b>3.2.2 Recording methodology</b>	<b>15</b>
<b>3.2.3 Archiving</b>	<b>15</b>
<b>3.3 Acknowledgements</b>	<b>16</b>
<b>3.4 Account of the 2014 Excavation</b>	<b>17</b>
<b>3.4.1 Trench 1A</b>	<b>17</b>
<b>3.4.2 Trench 1B</b>	<b>26</b>
<b>3.4.3 Trench 2</b>	<b>38</b>
<b>3.4.4 Introduction to Trenches 3 and 4</b>	<b>43</b>
<b>3.4.5 Trench 3</b>	<b>43</b>
<b>3.4.6 Trench 4</b>	<b>50</b>
<b>4. Discussion</b>	<b>56</b>
<b>4.1 Evidence of Pre-Fort activity</b>	<b>56</b>
<b>4.2 Evidence for Phase One</b>	<b>56</b>
<b>4.3 Evidence for Phase Two</b>	<b>57</b>
<b>4.4 Evidence for Phase Three</b>	<b>58</b>
<b>4.5 Evidence of different types of activity at the Fort</b>	<b>58</b>
<b>5 Conclusions</b>	<b>58</b>
<b>6 References</b>	<b>59</b>
<b>7 Appendices</b>	<b>60</b>
<b>Appendix 1: Harris Matrix</b>	<b>61</b>
<b>Appendix 2: Context Register</b>	<b>62</b>
<b>Appendix 3: Field Drawing Register</b>	<b>64</b>
<b>Appendix 4: Photographic Register</b>	<b>66</b>
<b>Appendix 5: Small Finds Register</b>	<b>89</b>

## ***List of Figures***

- Figure 1.** Grey Point Fort location map (NIEA).
- Figure 2.** Ordnance Survey 6", 4th Edition County Series Map, 1901-1957 illustrating the hutted encampment at Grey Point Fort (OSNI).
- Figure 3.** Detail of the 1931-32 plan of Grey point Fort showing the northern Blockhouse excavated in 2014.
- Figure 4.** Plan of Grey Point Fort today (after NIEA guide, ndg).
- Figure 5.** Map of Grey Point Fort showing the location of the trenches excavated in 2014.
- Figure 6.** Trench 1A. Plan of the fully excavated Blockhouse.
- Figure 7.** Trench 1A. East-facing profile of the Blockhouse, showing the western wall of the building and the later northern stone perimeter wall of the Fort and the associated extra-mural gravel path. Note the drop in the level of the bedrock, where it had been deliberately removed, in the area of the path.
- Figure 8.** West-facing profile through Trenches 1A and 1B Northern Extension showing the eastern wall of the Blockhouse, the later northern stone perimeter wall of the Fort and the associated extra-mural gravel path. Note the drop in the level of the bedrock, where it had been removed in the area of the path and also immediately south of the perimeter wall.
- Figure 9.** Trench 1A. South-facing section across the middle of the Blockhouse.
- Figure 10.** Trench 1A. North-facing section at the southern end of trench showing the stumps of the western and eastern walls of the Blockhouse and the later northern stone perimeter wall of the Fort built over these. Between the blockhouse walls layers of poured concrete and a concrete lintel were used to level up the uneven bedrock and provide a firm base for the perimeter wall.
- Figure 11.** Trench 1B, main trench. West-facing section.
- Figure 12.** Trench 1B, main trench. East-facing section.
- Figure 13.** Trench 1B, main trench. North-facing section.
- Figure 14.** Trench 1B, main trench. South-facing section.
- Figure 15.** Trench 1B, Northern Extension. West-facing section.
- Figure 16.** Trench 1B, Northern Extension. West facing section.
- Figure 17.** Trench 1B, Southern Extension. West- facing section.
- Figure 18.** Trench 2. Plan of main features- the remains of the iron fence pickets (in red) and the later electricity cables that ran in the direction of the most westerly of the coastal searchlight emplacements.
- Figure 19.** Trench 2. East-facing section showing one of the iron trench pickets (C.209), the cuts for the service cables to the most westerly of the coastal searchlight emplacements (C.213 and C.216) and the later gravel paths (C.202 and 204).
- Figure 20.** Trench 2. North-facing section showing one of the iron trench pickets (C.209) and the two later gravel paths (C. 202 and C. 204).
- Figure 21.** Trench 3. Plan of earthen shoreline defensive trench showing the stone surface (C.306/ 307) in the base of the trench and the drain (C.303/ 312) built into the eastern bank.

- Figure 22.** Trench 3. Plan of subsoil-cut drain (C.309) in the base of the earthen shoreline defensive trench and the larger drain (C.303) built into the eastern bank of the defence.
- Figure 23.** Trench 3. West-facing section across the eastern bank of the earthen shoreline defensive trench showing the drain (C.303) built into the bank and which linked up with the smaller subsoil-cut drain (C.309) in the base of the trench.
- Figure 24.** Trench 3. North-facing section through earthen shoreline defensive trench.
- Figure 25.** Trench 3. South-facing section through the earthen shoreline defensive trench.
- Figure 26.** Trench 4. East-west profile across the entrance of the dugout and earthen shoreline defensive trench.

### ***List of Plates***

- Plate 1.** 1907 Plan of War Office Lands and Encroachments at Grey Point, Helen's Bay, County Down (KEW WO 78/4730).
- Plate 2.** Plan of Grey Point Battery in 1911 (PRO WO 78/4784; reproduced in Clements 2003, 66).
- Plate 3.** Detail of a map contained in the W. O. 33/601 document (*Ireland's Defence Scheme: North Irish Ports Part II, Belfast Defences (Revised to July 1912)*) entitled *North Irish Defended Ports Scheme: Map of Belfast Defences*. The heavy red line indicates *Coast practicable for [enemy] landing* and the lighter dashed red line marks map shows the *General Line of Defence* around the two coastal batteries on either side of Belfast Lough. The map enforces picture of the symbiotic relationship between the Grey Point Fort Battery and the Kilroot Battery and their perceived crucial importance in the defence of Belfast Lough in the years immediately prior to the First World War.
- Plate 4.** Blue Print of Grey Point Fort Camp *circa* 1914/15 (KEW WO 78/4730).
- Plate 5. Royal Engineers' Plan, Grey Point Fort Camp, 1915: (IE/MA/MPD/AD119287-008) ([www.militaryarchives.ie](http://www.militaryarchives.ie))
- Plate 6.** Aerial photograph of Grey Point Fort showing the location of the trenches excavated in 2014.
- Plate 7.** Trench 1A. The internal area of the Blockhouse excavated to the level of bedrock. From the south.
- Plate 8.** Trench 1A. The internal area of the Blockhouse excavated to the level of bedrock. From the north. At the top of the photograph the stumps of the eastern and western walls of the blockhouse are visible below the later northern stone perimeter wall of the Fort.
- Plate 9.** Trench 1A. The southern end of trench showing the stumps of the western and eastern walls of the Blockhouse and the later northern stone perimeter wall of the Fort built over these. Between the Blockhouse walls layers of poured concrete and a concrete lintel were used to level up the uneven bedrock and provide a firm base for the perimeter wall.
- Plate 10.** Trench 1A. The fully excavated Blockhouse from the south-west. At the far left of the shot the later northern stone perimeter wall of the Fort is visible. Also visible are the modern gravel

path and the section of bedrock and the sections of the western and eastern walls of the Blockhouse which had been removed to facilitate the creation of the path.

**Plate 11.** Trench 1B, main trench. Iron fence pickets C.1013A and C.1013B during excavation. From the South.

**Plate 12.** Trench 1B, main trench fully excavated to the level of bedrock. From the South.

**Plate 13.** Trench 1B, main trench. North-east corner. Detail of fragment of concrete in C. 1017 with an impression and portion of iron fitting that matches the dimensions of the excavated fence pickets and which may have been a base of such a defensive structure.

**Plate 14.** Trench 1B, Northern Extension. South-facing section, showing the later stone perimeter wall of the Fort founded on the concrete lintel and layers of poured concrete and the drop in bedrock where this has been removed. In the background of the shot is Trench 1A/ the concrete Blockhouse over which the stone perimeter wall had been built.

**Plate 15.** Trench 1B, Northern Extension. West-facing section showing the later stone perimeter wall of the Fort founded on the concrete lintel and layers of poured concrete. The drop in bedrock where this has been removed is very visible as are the later dumped layers of gravel and sand.

**Plate 16.** Trench 1B, Southern Extension. West-facing section.

**Plate 17.** Trench 1B, Southern Extension. South-facing section.

**Plate 18.** Trench 2 from the East. Detail of the two service trenches (C. 216 and C. 213) and the service cables (C. 211).

**Plate 19.** Trench 2 from the North. Trench excavated to subsoil level with the stumps of four iron fence pickets in the foreground and the later service trench with the service cables in the background.

**Plate 20.** Trench 3. Stone surface (C.306/ 307) in the base of the trench and the drain (C.303/ C.312) built into the eastern bank. From North.

**Plate 21.** Trench 3. The subsoil-cut drain (C.309) in the base of the earthen shoreline defensive trench and the larger drain (C.303) built into the eastern bank of the defence. From North.

**Plate 22.** Trench 3. As Plate 21 but from the West.

**Plate 23.** Trench 3, post-excavation with subsoil-cut drain (C.309) in the base of the earthen shoreline defensive trench and larger drain (C.303). Visible at the extreme right of shot are the stones (C.312) of the drain emerging from the outer face of the bank where water in the base of the trench was diverted downslope and out of the trench.

**Plate 24.** Trench 4. The dugout pre-excavation, October 2014. From West.

**Plate 25.** Trench 4. The dugout mid-excavation. Note also the base and western bank of the adjacent earthen shoreline defensive trench. From North.

**Plate 26.** Trench 4. The wiggly tin uncovered in the northern half of the dugout. Note also the stone revetment in the northern, eastern and south-western banks of the dugout. From West.

**Plate 27.** Trench 4. Detail of the wiggly tin in the northern half of the dugout. The tin in the middle of the shot (below the larger ranging rod) probably represents collapsed roofing. That to the

left of the shot, along the inner face of the northern is probably revetting of the walls of the structure. From West.

**Plate 28.** Trench 4. As Plate 27, but from South. Note post-abandonment badger set in the north-east corner of the dugout and the tree growing on the eastern wall.

**Plate 29.** Trench 4. The dugout when excavation ceased in November 2014. The exposed wiggly tin is in the foreground covered by the thick layer of slump (C.404) from the dugout banks which has accumulated post-abandonment. From North.

### ***List of Tables***

**Table 1.** Archaeological sites in Ballygrot townland (from NISMR).

## 1. Summary

An archaeological excavation was carried out at Grey Point Fort, Co. Down, by the CAF in October and November 2014. The excavation was commissioned and funded by the Northern Ireland Environment Agency (NIEA). The primary research aims of the excavation were to uncover new information about Grey Point Fort Coastal Battery, Co. Down, and to enhance the visitor experience at the monument. To this end excavations were carried out at five locations in and around this State Care monument between 6th October and 11th November 2014 (Figure 1). The excavations mostly focused on the outer areas at the fort including the northern Blockhouse (bastion), the western side of the perimeter wall and the frontal shore defences in the environs of the east searchlight emplacement. Much useful and exciting information about the sequence and techniques of construction and activity at the Fort was uncovered from the excavation. The information uncovered will also be entered into the NIEA Defence Heritage database as part of the ongoing Defence Heritage Project (DHP). The archaeological investigations were carried out on behalf of the NIEA by the Centre for Archaeological Fieldwork, School of Geography, Archaeology and Palaeoecology, Queen's University Belfast under the co-direction of Ruairí Ó Baoill and Heather Montgomery.



Figure 1. Grey Point Fort location map (NIEA).

## 2. Introduction and background

### 2.1 General

This Data Structure Report (DSR) details the results of an archaeological excavation undertaken at Grey Point Fort (DHP No. 315; Grid ref J 45698 83254) in Autumn 2014 by the Centre for Archaeological Fieldwork (CAF) on behalf of the Northern Ireland Environment Agency (NIEA). The excavations were mostly focused on the



outer areas at the fort including the northern Blockhouse, the western side of the perimeter wall and the frontal shore defences in the environs of the east searchlight emplacement. The excavation were carried out over five and a half weeks from October 6th to November 11th, 2014 and was co-directed by Ruairi Ó Baoill and Heather Montgomery (Licence No. AE/14/170)

## 2.2 Historical Background

Grey Point Fort, Helen's Bay, Co. Down, is considered one of the better preserved examples of a restored 20th century Coast Defence Battery within Ireland and Britain. It was constructed to defend the important shipyards of Belfast, and Belfast Lough generally. The Fort is located on the southern shore of Belfast Lough with exceptional vistas of the approaches into the lough. The site of the current Fort has been occupied for nearly 100 years despite the Fort being decommissioned in 1956 (Figure 2). It is currently utilized as a visitor attraction within the Crawfordsburn Country Park and is both owned and managed by the NIEA. Within the Fort is a small museum looked after by the Grey Point Fort Amateur Radio Society who is also responsible for the vast array of artefacts exhibited at the museum.

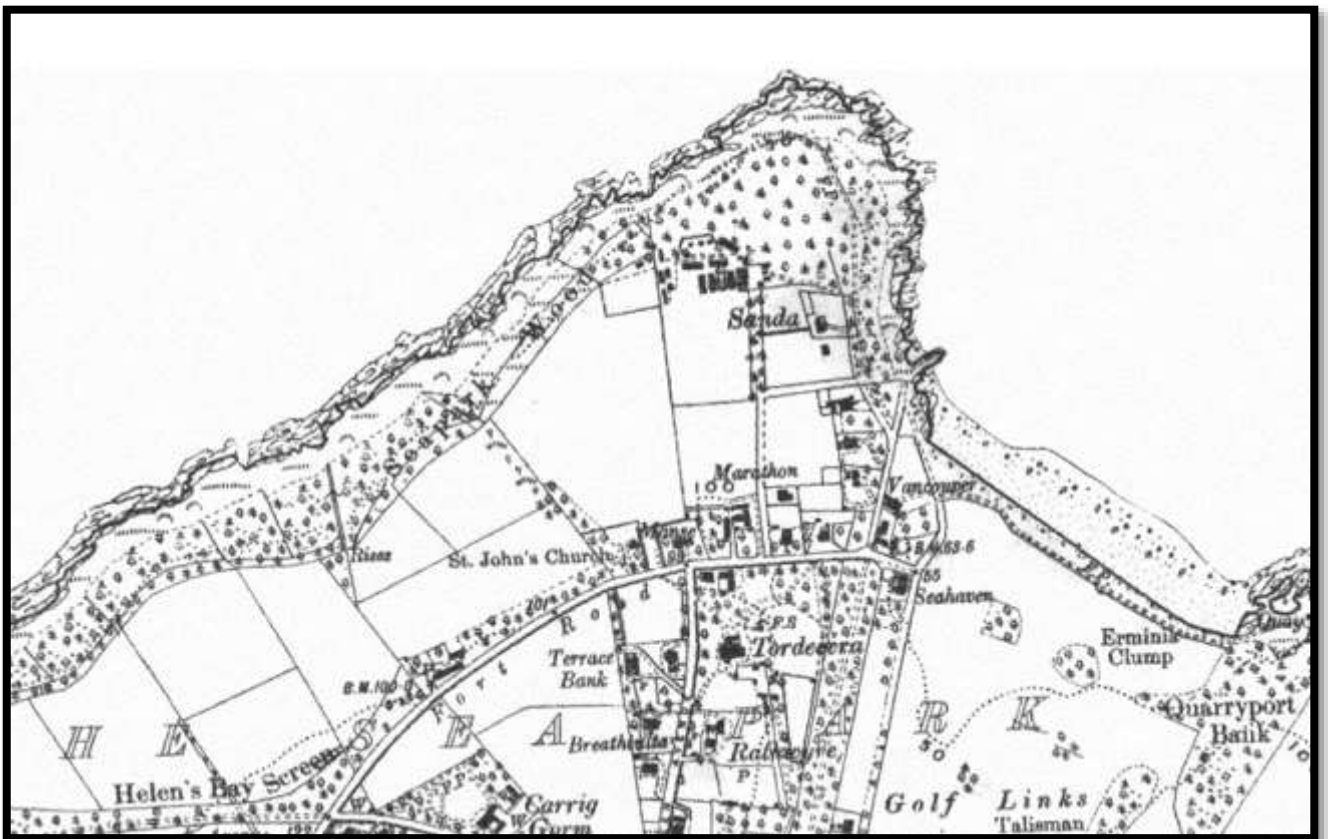
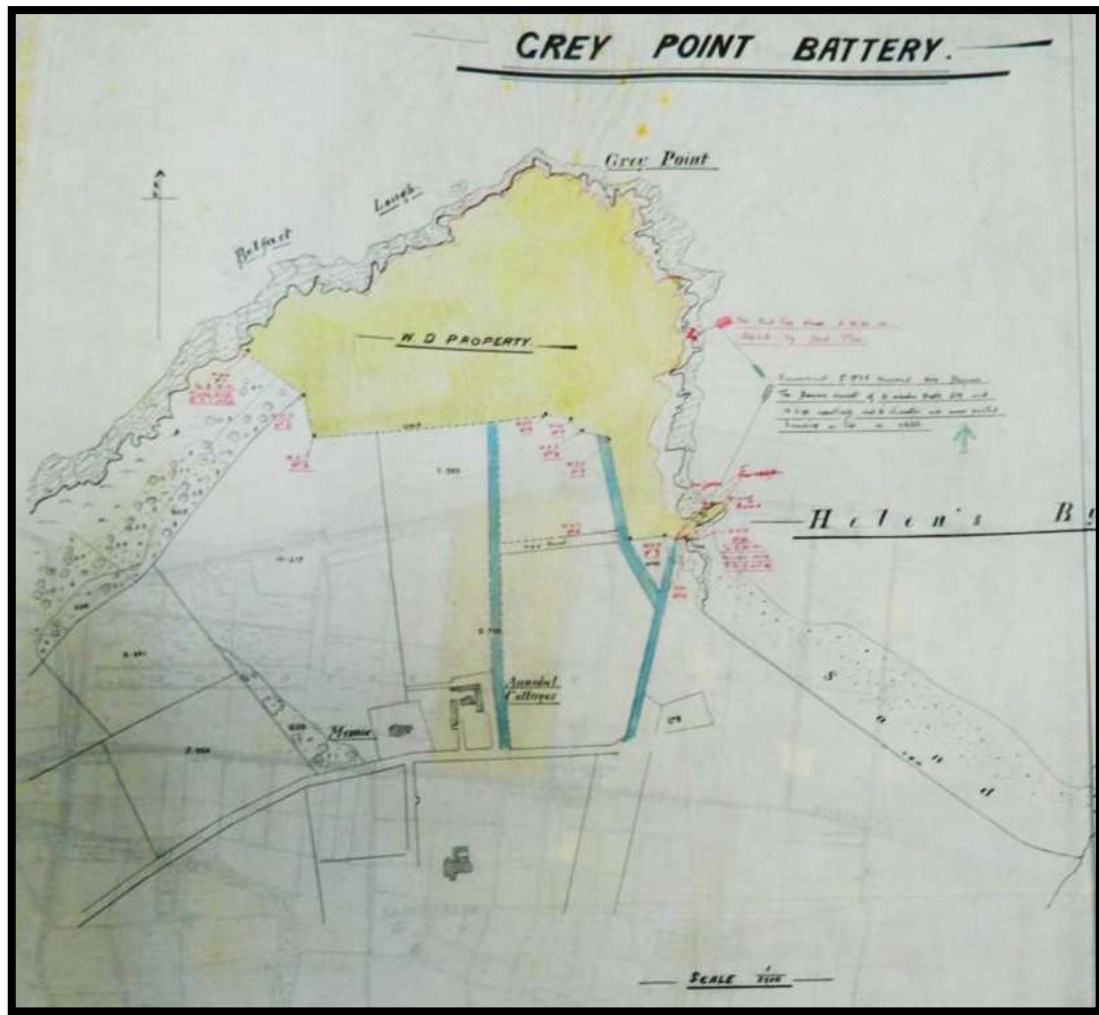

Figure 2. Ordnance Survey 6", 4th Edition County Series Map, 1901-1957 illustrating the hutted encampment at Grey Point Fort (OSNI).

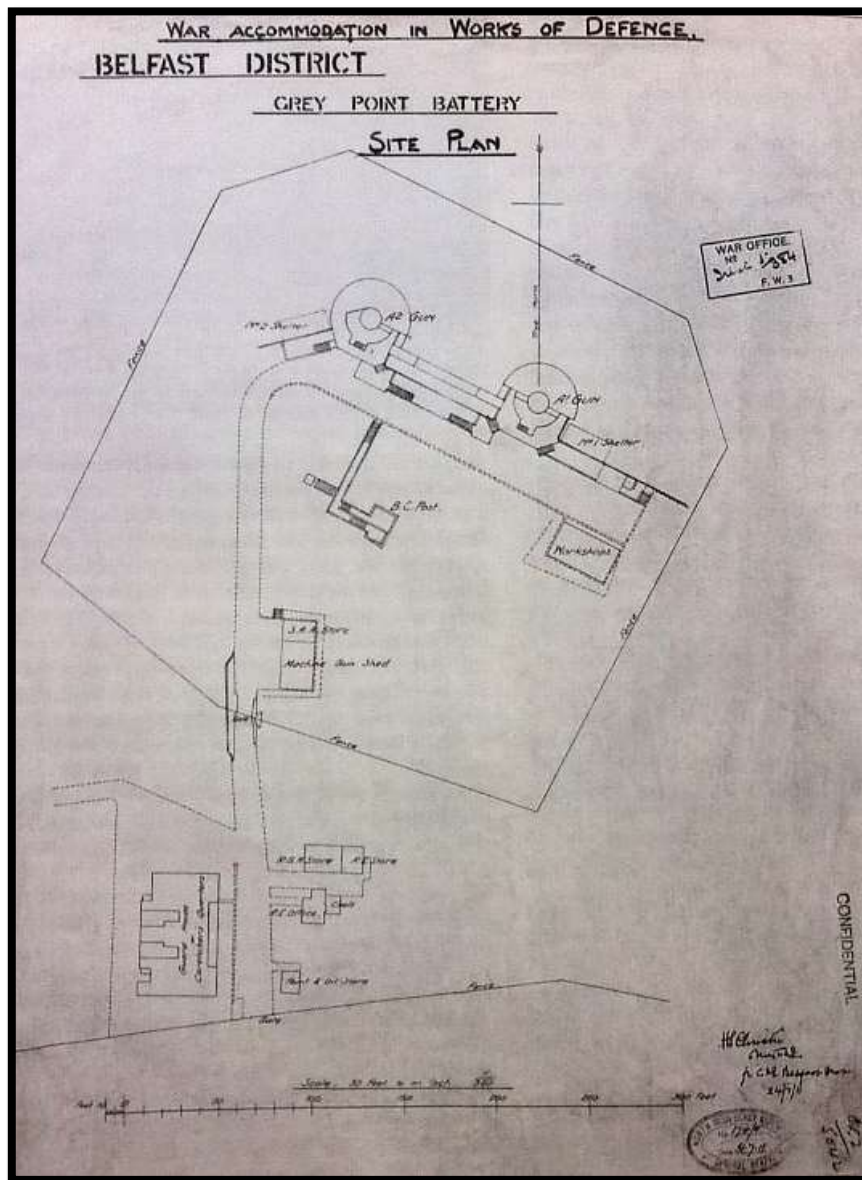

**Plate 1. 1907 Plan of War Office Lands and Encroachments at Grey Point, Helen's Bay, County Down (KEW WO 78/4730).**

The Fort was built as a pentagonal-shaped Coast Defence Battery on land bought from Marquess of Dufferin and Ava for £8,400. The first records of construction work at the site, carried out by Messer's W. J. Campbell & Son of Ravenhill Road Belfast, date to 1904 with the Fort becoming operational by 1907 (Plate 1). Two six-inch Mark VII breech-loading guns (made by Vickers & Maxim Ltd) were initially installed in 1907 when the fundamental structure (that is the core elements of the gun battery) of Grey Point was completed. Associated outbuildings were constructed over the next three years providing workshops, shelters, stores facilities and other ancillary buildings prior to the outbreak of the First World War (Clements 2003, 62-68).

In addition to the construction of Grey Point Fort to aid in the defence of Belfast, the recommendations of the Owen Committee, set up in 1905 by the War Office and the Admiralty to report on updating coastal defences, required that a second similar battery be constructed on the opposite/ northern side of Belfast Lough at Kilroot. This second battery would be employed as the 'examination depot' for ships and other vessels making the journey up Belfast Lough, the location at which all crafts had to signal their information and intentions and where they had to register before then being permitted to travel further into the lough.

The Kilroot Battery was not completed until 1910 with the final fortifications recorded as having been similar to Grey Point: both forts contained dual gun emplacements with 'barbette' mountings (protective armour mounting for cannon or heavy artillery gun) and associated magazines, shell stores and shelters constructed below the gun positions. While the archive illustrates that Grey Point Fort was initially pentagonal in shape (Plate 2; PRO WO 78/4748), Kilroot was laid out in a more diamond-shaped fashion.



**Plate 2. Plan of Grey Point Battery in 1911 (PRO WO 78/4784; reproduced in Clements 2003, 66).**

As the various powers in Europe geared up for what became World War I, there were clearly fears of a potential attack on the important shipyards at Belfast. The British War Office document *W. O. 33/601 Ireland's Defence Scheme: North Irish Ports Part II, Belfast Defences (Revised to July 1912)* assessed both the likely landing spots around Belfast Lough that could be used by an enemy and the resources available to counter

any potential threat. The new coastal defences at Grey Point were to be part of this defensive strategy and the document states that *On the southern shore of Belfast Lough The Special Reserve Infantry at Grey Point Battery will provide patrols to watch the shore of the Lough, by day and night between the battery and Ballyholme Bay, both inclusive; and at night, standing patrols at Bangor and Ballyholme Bays (W. O. 33/601, 24). In addition, Patrols furnished by the 4th B[attalio]n Royal Irish Rifles at Holywood will watch the shore of the Lough between Holywood (inclusive) and Grey Point Battery (ibid 25).*

Potential threats to Grey Point Fort were specified in the section of the document covering *Details of the methods proposed for meeting the various forms of Attack (Naval and Military) to which the Port [Belfast] is considered liable.* These are discussed in *Section B- The following forms of landing attack have to be considered and guarded against in the war period:-*

(a) *Attack on Grey Point Battery or Kilroot Battery, or on both batteries.*

*This attack may take the form of-*

(1.) *A landing in the vicinity of the batteries by day.*

(2.) *A landing at night in close vicinity of the batteries, with a view to their assault under the cover of darkness or at dawn.*

(b) *Raiding attacks by light draught vessels or armed launches with landing parties, which might attempt to enter the Victoria Channel by night, with a view to the destruction of dock gates, docks and shipping.*

(c) *Attack on naval war signal and wireless telegraph stations, and cable landing places.*

*The forms of attack (a.), (1.) and (2.) will be considered separately in the case of each battery:- Grey Point Battery.- (a.)...*

*A barbed-wire entanglement has been erected around the battery. In the war period trenches and machine-gun emplacements will be constructed, commanding Helen's Bay and the land approaches; and an outer line of wire entanglements will be constructed, enclosing the land defences*

*The arrangements for cyclist patrols on the southern shore of the Lough are detailed in Chapter II., C.2.*

*In addition, picquets furnished by the Special reserve infantry at Grey Point Battery will be stationed at night at Bangor and Ballyholme Bay. (ibid 29).*

*...In the event of a landing at night at Bangor or Ballyholme Bays, the picquets will oppose the landing, and if forced to retire, will fall back towards Grey Point Battery.*

*The Holywood battalion will be railed to Helen's Bay Station and will occupy defensive positions which connects with the eastern land defences of Grey Point Battery by trenches along the west edge of the golf links, across which a barbed-wire entanglement and abates will be constructed.*



**Plate 3. Detail of a map contained in the W. O. 33/601 document (*Ireland's Defence Scheme: North Irish Ports Part II, Belfast Defences (Revised to July 1912)*) entitled *North Irish Defended Ports Scheme: Map of Belfast Defences*. The heavy red line indicates *Coast practicable for [enemy] landing* and the lighter dashed red line marks map shows the *General Line of Defence* around the two coastal batteries on either side of Belfast Lough. The map enforces picture of the symbiotic relationship between the Grey Point Fort Battery and the Kilroot Battery and their perceived crucial importance in the defence of Belfast Lough in the years immediately prior to the First World War.**

Proposals were drawn up in 1913 for the installation of concrete blockhouses at Grey Point Fort, intended to provide protection for from attack from the land (Clements 2003, 67-68). However, the existing fort records indicate that these had not been installed by the start of the First World War but later as a consequence of the hostilities in Europe with the potential threat from sea in addition to the current political unrest in Ireland at the time. Three diamond-shaped blockhouses were raised with the intention they would reinforce land-front earthworks at the promontory, constructed at both the East and West corners of the Fort wall and in the centre of the northern wall.

Plans from the early 20th century indicate that the Fort was additionally fortified by wide barbed-wire entanglements with the blockhouses acting as caponiers, a type of fortification structure serving as a covered

means of access to outworks while enabling protected rifle fire to be better directed against the possibility of any breach in defences by the enemy.

The Orlock Port War Signal Station was established further around the Co. Down coast at Donaghadee and was employed in the identification of warships on their approach to Belfast Lough, informing naval headquarters and in turn the garrison commander at Grey Point by telephone of any approaching vessels. By 1916 the Battery Command Post was established at Grey Point Fort and oversaw operations at Kilroot, Orlock Point, East Twin Island and the Carrickfergus Garrison Artillery.

In 1914 mobilization for war necessitated the construction of supplementary housing for the officers and men of the permanent garrison from the Royal Artillery. Lands acquired by the war office to the south-west of the main Fort (Plates 4 and 5), were developed and construction of Armstrong hutting began. A Royal Engineers' Plan of the Fort, c.1915 provides reference to these structures, they comprised Barrack huts, Sergeant's mess, canteen, cook house and dining area, guard house and regimental office, ablutions shed and latrines, drying room, coal store and harness room, affording accommodation for six Officers and 172 Other Ranks of the Royal Garrison Artillery (Plate 5).

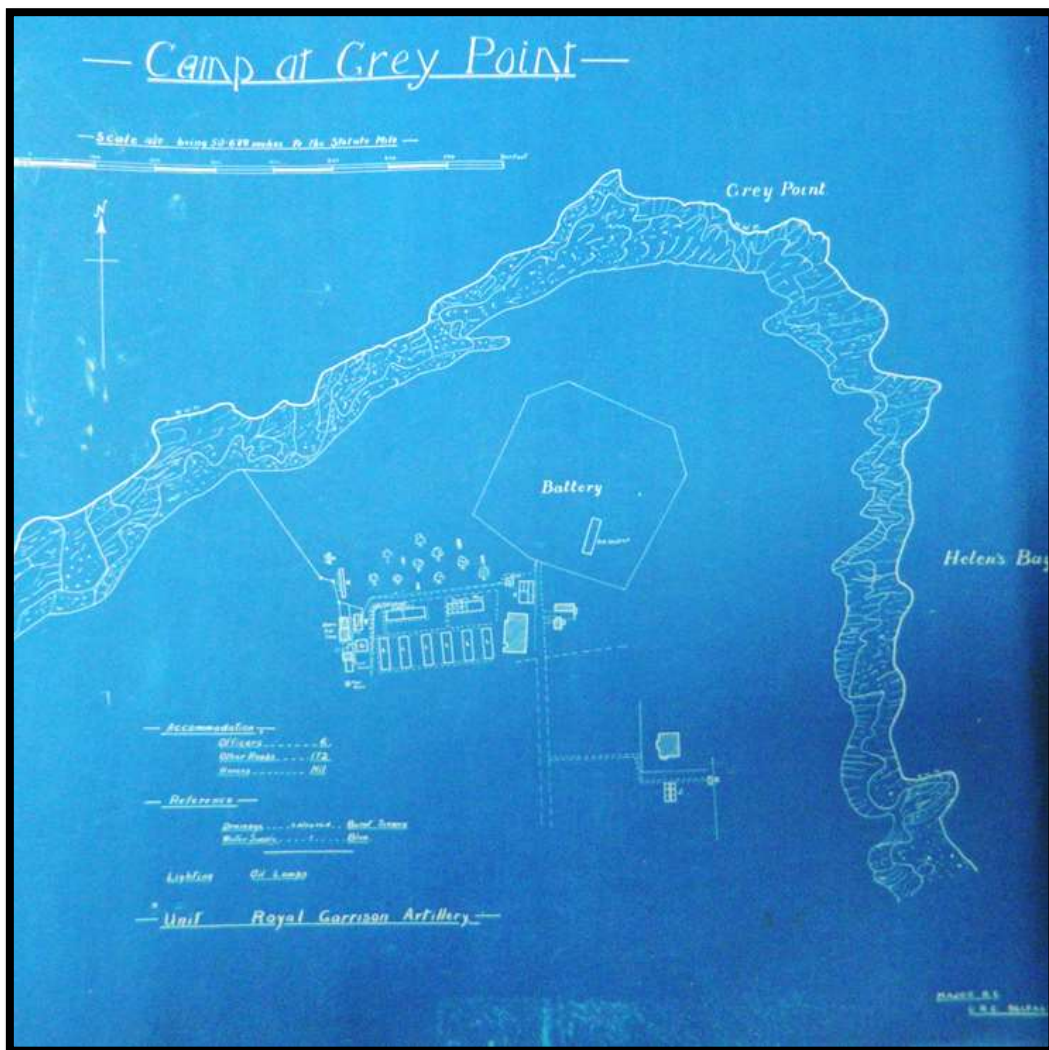
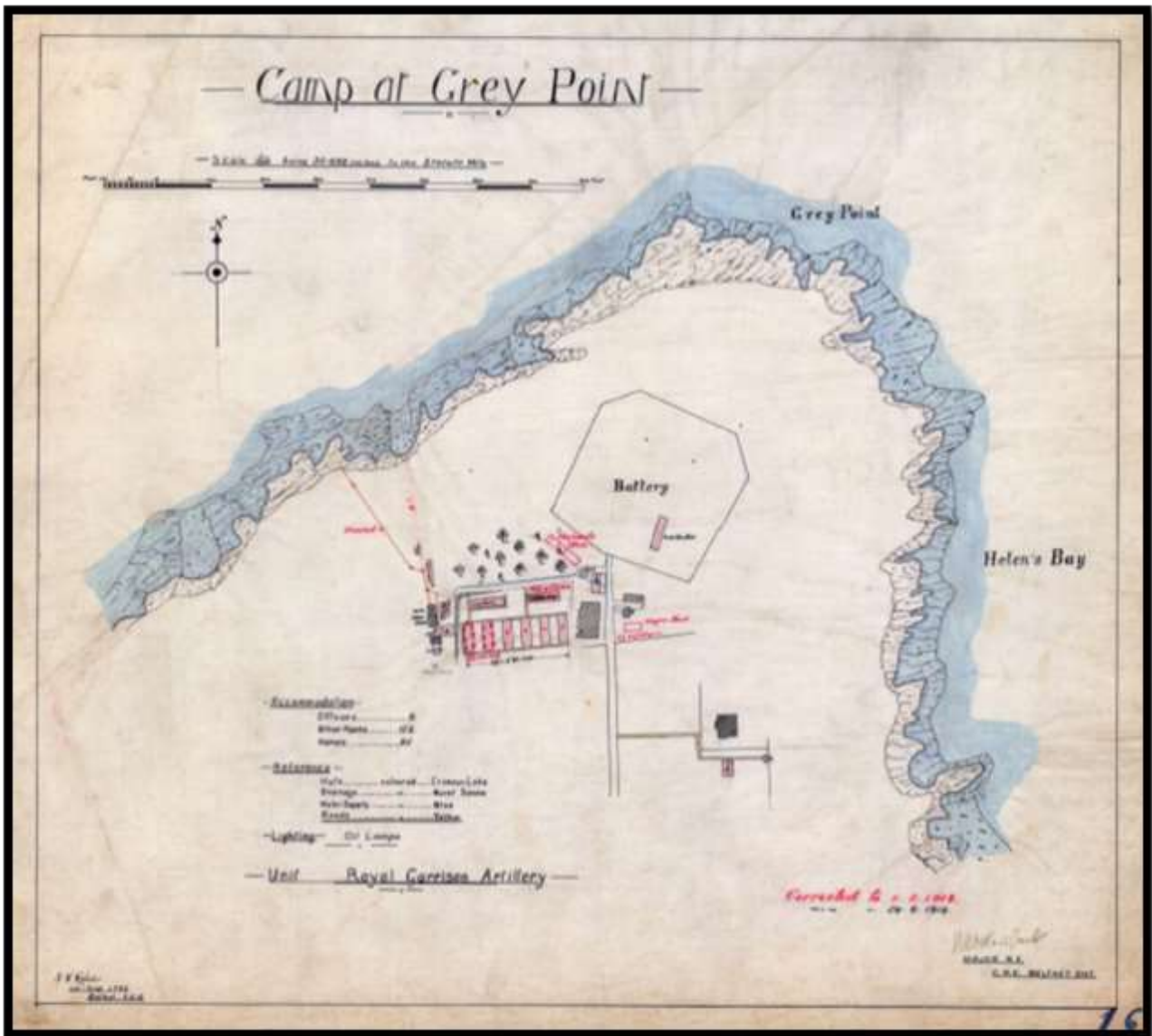

Plate 4. Blue Print of Grey Point Fort Camp circa 1914/15 (KEW WO 78/4730).



**Plate 5. Royal Engineers' Plan, Grey Point Fort Camp, 1915 (IE/MA/MPD/AD119287-008)**  
**([www.militaryarchives.ie](http://www.militaryarchives.ie))**

As the war progressed an additional building was acquired to the south-east of the battery for an Officer's mess; furthermore changes were made in the use of some of the temporary hutting most notably the re-assignment of the sergeant's mess for use as a Machine Gun Office.

Historical investigations have found reference to the use of the Battery by training battalions of the 36th Division of Kitchener's New Army, in particular the 13th Battalion of the Royal Irish Rifles who were billeted at the nearby Clondeboye Training Camp and regularly marched across to the Fort for instruction in the use of Machine Guns, 1914 -18 (Ulster Rifles Museum, Waring Street, Belfast, 2316 a/b/c).

Although the Fort never saw action during the First World War, the defence battery was maintained after the war as part of the permanent coastal defence of Belfast and Belfast Lough. Further amendments were made

to the camp and the main Fort during this period, including the installation of two large coastal search lights in 1936.

On the 24th August 1939, Grey Point Fort became fully operational again as the outbreak of the Second World War loomed. Construction of the concrete gun houses began in 1939 as defence against the threat from the air became the primary concern requiring the coastal defence guns to be safeguarded. Rectangular concrete concealments were established to shelter the guns with additional accommodation erected during the summer of 1939. The Battery was also armed with one 3 inch anti-aircraft gun as well as a single Lewis gun position and by 1941 there were two 6 inch guns in place at the Fort.

Grey Point Fort was 'down-graded' in August 1943, along with the structural remains of the main battery the Fort was then used only as the HQ for the 525th Antrim Coastal Regiment of the Royal Artillery as a Naval Station. This was in view of the fact that the coast defence at Orlock, Co. Down, took over the protective role at the entrance at Belfast Lough.

At the end of the Second World War Grey Point Fort continued to be maintained. In 1954 a mobile radar (AA No.3 Mark 2/7) was installed. Grey Point Fort ceased operations as a coastal defence battery in February 1956 leading to the eventual abandonment of the Fort in a formal military fortification apart from occasional use by the OTC from Queen's University, as a training ground. Grey Point Fort was incorporated into Crawfordsburn Country Park in 1971. The Fort has been used since 2008 by the Grey Point Amateur Radio society who have permission from the NIEA to occupy and maintain the Fort. Members of the society have provided access to their private collections of WW1 and WW2 military memorabilia, presenting a small museum to the visitor experience.

Although a range of documentary evidence relating to the history of the Fort and its various phases of use exists there is much that is still unknown about how precisely the fortification actually developed throughout the 20th century. A number of military plans exist for the battery illustrating various stages of the Fort's development. These include the *Mapping of War Office Boundaries and Encroachments for the lands at Grey Point*, c.1907 (KEW WO78 4730); a plan indicating earthworks, trenches, barbed wire entanglements and locations of various ancillary buildings, c.1911 (KEW WO78 5208); a Royal Engineers plan of the Fort c.1915 (IE/MA/MPD/AD119287-008) as well as plans dating c.1931-32 which appear to document later modifications leading up to the Second World War. These documents shed faint light on the early construction phase of the Fort. One of the purposes of the 2014 excavation is to try and fill in some of the gaps in information that currently exists regarding the fort.



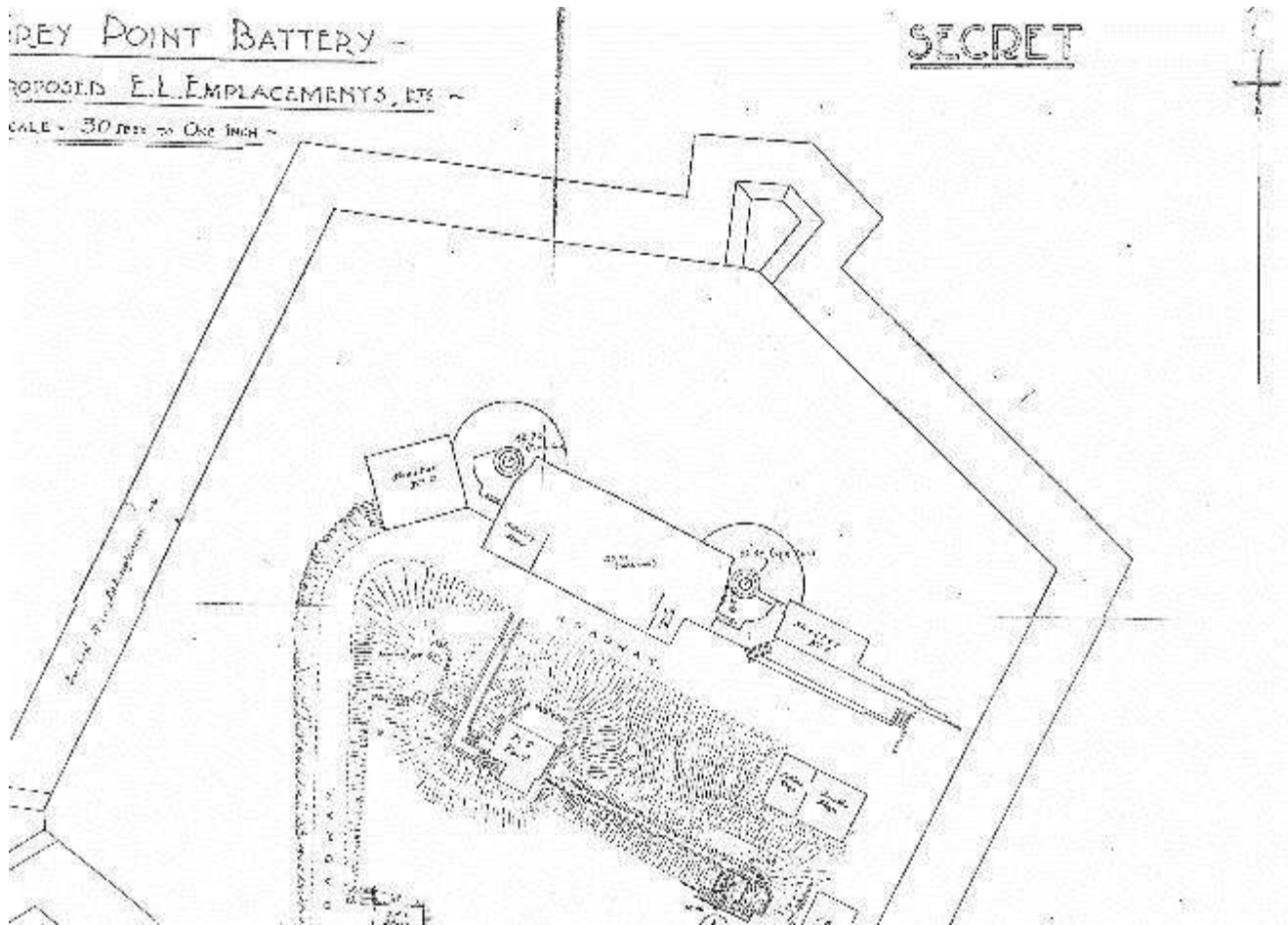

Figure 3. Detail of the 1931-32 plan of Grey point Fort showing the northern Blockhouse excavated in 2014.

### 2.3 Grey Point Fort today (Figure 4)

The restored Grey Point Fort coastal artillery site currently consists of a perimeter wall within which a number of military features are contained.

The Fort is a State Care monument. It is listed in the NIEA Defence Heritage database as monument No. 315. The three coastal artillery searchlights associated with the Fort are also recorded in this database (Nos. 316-318). There are also a number of earthen shoreline defences including trenches, dugouts and machine gun emplacements between the Fort proper and the shore.

The main components of the Fort, marked on the plan below are:

1. Quarters/ Guard house.
2. The Engine House.
3. The Entrance.
4. The Gun Store.
5. The Battery.
6. The Magazine.

7. Shelters.
8. The battery observation Post.
9. The Fire Command Post.
10. The Radar Platform.
11. The Searchlight Emplacements.

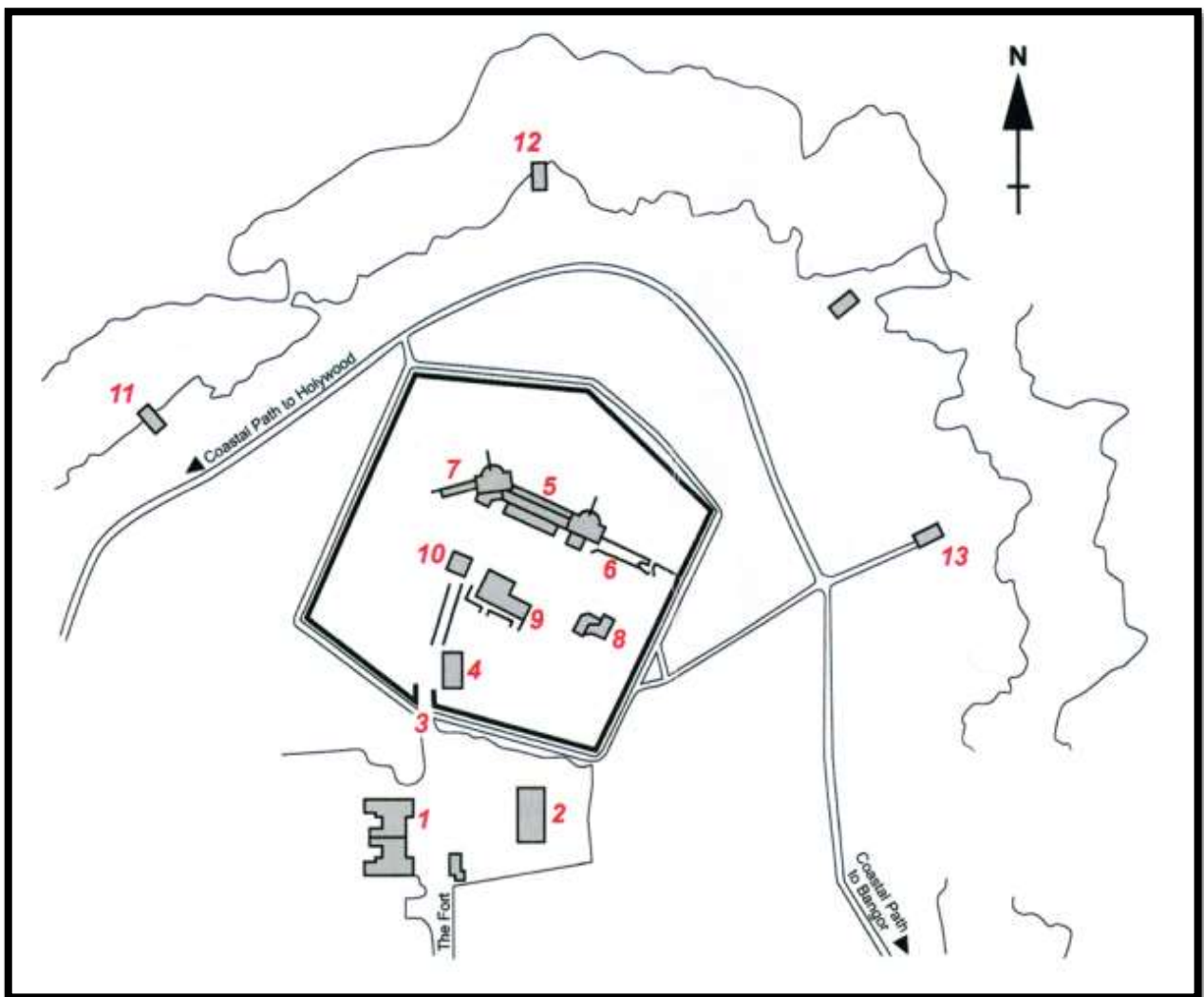

Figure 4. Plan of Grey Point Fort today (after NIEA guide, ndg).

## 2.4 Archaeological Background

The proposed 2014 excavation was the first archaeological investigation undertaken at Grey Point Fort and of any WW1 Coastal Defence location in Ireland. The Fort lies within Ballygrot townland and there are a number of other known archaeological sites within the townland recorded in the Northern Ireland Sites and Monuments Record (NISMR). These include a Mesolithic occupation site (close to the Fort), an Early Christian rath, a water mill, a church, a holy well and a variety of miscellaneous enclosures (Table 1.)

<b>NISMR No.</b>	<b>Site Type</b>
<b>DOW 001:012</b>	<b>Rath</b>
<b>DOW 001:014</b>	<b>Enclosure</b>
<b>DOW 001:015</b>	<b>Church and Holy Well</b>
<b>DOW 001:016</b>	<b>Enclosure</b>
<b>DOW 001:017</b>	<b>Tree Ring ('Tennyson's Clump')</b>
<b>DOW 001:030</b>	<b>Mesolithic occupation site (Grey Point)</b>
<b>DOW 001:037</b>	<b>Triangular enclosure</b>
<b>DOW 001:039</b>	<b>Water Mill</b>
<b>DOW 001:040</b>	<b>A.P. Site - tree ring?</b>
<b>DOW 001:041</b>	<b>A.P. Site - enclosure</b>

**Table 1. Archaeological sites in Ballygrot townland (from NISMR).**

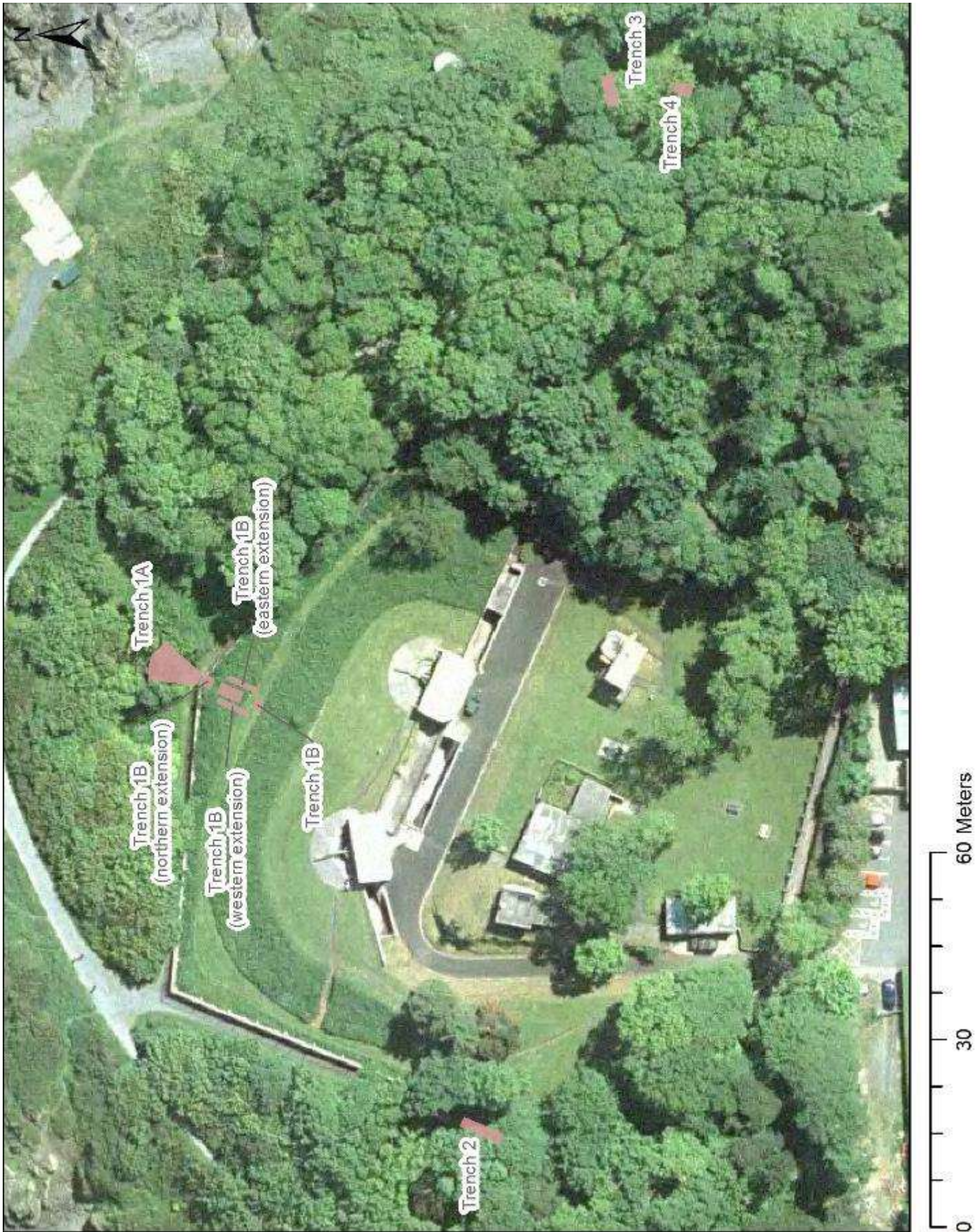

Plate 6. Aerial photograph of Grey Point Fort showing the location of the trenches excavated in 2014.

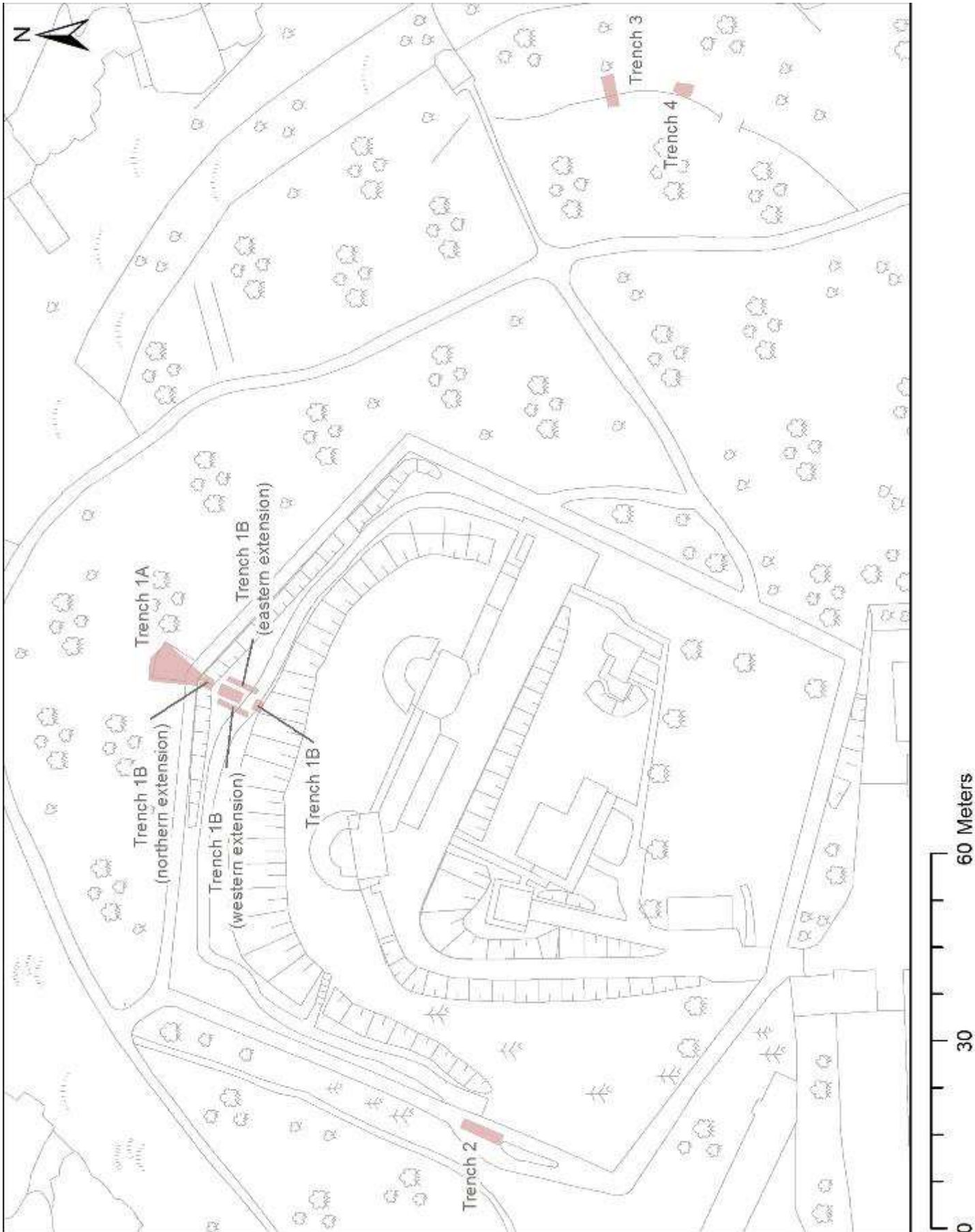

Figure 5. Map of Grey Point Fort showing the location of the trenches excavated in 2014.

### **3. The 2014 Excavation**

#### **3.1 Circumstances of the Excavations**

Between 6th October and 11th November 2014 archaeological investigations were carried out at Grey Point Fort by the Centre for Archaeological Fieldwork, School of Geography, Archaeology and Palaeoecology, Queen's University Belfast under the co-direction of Ruairí Ó Baoill and Heather Montgomery. The work was carried out on behalf of the NIEA. A total of five trenches were investigated in and around Grey Point Fort. The trenches were excavated to uncover new information about Grey Point Fort Coastal Battery, Co. Down, to assess the level of survival of both structures and the external earthen coastal defences in the landscape around the Fort and to enhance the visitor experience at the monument. The excavations mostly focused on the outer areas at the Fort including the northern Blockhouse (bastion), the western side of the perimeter wall and the frontal shore defences in the environs of the east searchlight emplacement. The archaeological investigations uncovered much useful and exciting information about the sequence and techniques of construction and activity at the Fort, as well as informing about the level of survival of the more ephemeral earthen shoreline defences around the coastal battery.

#### **3.2 Methodology.**

##### *3.2.1 General*

All of the five trenches were excavated manually. All but Trench 4 were fully excavated to bedrock or subsoil level and three broad sequences of 20th century activity were identified across the site (see Appendix 1: The Harris Matrix and Section 4 of this report).

##### *3.2.2 Recording Methodology*

The context records for the excavation were created using the standard context recording method: all built features and deposits were assigned a unique context number and pro-forma (Context sheet) was completed for each. All features were photographed prior to and following excavation and a series of plans and sections were completed throughout the excavation at scales of 1:10 or 1:20, as appropriate. A field notebook was also maintained.

The Harris Matrix is presented in Appendix 1 and the Context Register is detailed in Appendix 2. The Field Drawing Register is presented in Appendix 3 and the Photographic Register is catalogued in Appendix 4. The Small Finds Register is contained in Appendix 5.

##### *3.2.3 Archiving*

Copies of this report have been deposited with the NIEA. All site records and finds are temporarily archived with the School of Geography, Archaeology and Palaeoecology, Queen's University Belfast.

### 3.3 Acknowledgements

The Directors would like to thank the following persons and institutions:

The Northern Ireland Environment agency who commissioned and funded both the archaeological excavation and the ongoing post-excavation work to bring the excavation to publication.

**CAF:** The CAF archaeologists who worked on the excavation were Dr Harry Welsh, Ruth Logue, Dermot Redmond, Stuart Alexander, Naomi Carver and Sapphire Mussen.

Dr Siobhán McDermot was most helpful with regard to the Lidar and other surveys of the Fort.

**NIEA:** Especially Emma McBride, also John Murphy, Dr John O' Keeffe, Dr Vicky Ginn, James Patience, Gail Pollock, and Tony Corey.

There were NIEA personnel on site daily during the excavation and these included Emma McBride, Fearghal Adams, Gail Howell, Gina Baban, Jackie McDowell, Kara Ward, Thomas Kerr and John Murphy.

Barry Millar, CPD structural engineer.

**School of Geography, Archaeology and Palaeoecology, Queen's University Belfast:** Dr Alistair Ruffell

A number of Volunteers participated on the excavation during the first and third weeks of the excavation:

Robin Masefield, Kate Todd, Deanna Montgomery-Shields, Simon Kane, Aidan Keane, Johnny McNee, Billy Phair and Karine Wright.

The Ulster Archaeology Society Survey Group, especially Dr Harry Welsh and Lee Gordon, who spent Saturday 25th October carrying out a complete internal survey of the walls and buildings of the Fort, the first ever compiled, tied into base points established by NIEA surveyors.

Police Service of Northern Ireland: Glynn, Ordnance expert.

Grey Point Fort Radio volunteers: Thomas, Philip, Stephen, Jimmy, Jackie, Eddie, Charlie, Billy and all other members who helped during the excavation.

David Craig at Irishsights (<http://www.irishsights.com>)

Duncan Berryman

#### **Outreach during the excavation**

During the second week of the excavation almost 200 school children from local schools visited the excavation, were given a tour of the Fort and excavated trenches, and were allowed to participate in the excavation. The schools included Towerview Primary School, Bangor Central School, Grange Primary School and Rockport Primary School,

Two public Open Days were held at Grey Point Fort on the 11th and 18th October 2014. Hundreds of people visited the Fort and the excavation on these days. Both CAF archaeologists and NIEA personnel were on site for both of these Open Days. On the second Open Day Scouts from the Jamboree at Crawfordsburn Scout Camp and Defence Heritage Project volunteers were among the visitors to the site as well as Belfast Young Archaeologists Club members (who also got a chance to do a little supervised excavation).

### **3.4 Account of the 2014 excavation** (Fig. 5; Plate 6)

A total of five trenches (Trench 1A, Trench 1B and Trenches 2-4) were excavated between 6th October and 11th November 2014. The proposed excavations focused on the outer areas at the Fort including at the north Blockhouse (bastion), the western side of the perimeter wall and at the frontal shore defence area in the location of the east searchlight emplacement. All investigations were carried out by hand and trenches were backfilled on completion of excavation. Trenches 1A and 1B were separate trenches but in line with one another either side of the apex of northern stone perimeter wall of the Fort.

#### **3.4.1 Trench 1A** (Figures 6-10; Plates 7-10)

Trench 1A was located in the interior of the concrete Blockhouse immediately adjacent to the apex. Excavation of the trench identified the layout of the Blockhouse, any internal features and how it related to the perimeter wall, providing evidence about the phases of construction at the fort as well as defining the depth of infill and stratigraphy. The trench was initially 4m wide, east-west, x 2m long, north-south, and located within the southern half of the Blockhouse immediately north of the apex of the northern perimeter wall of the fort. Excavation progressed so efficiently that the whole of the interior was archaeologically excavated during the 2014 excavation. No internal features were identified.

Bedrock was uncovered at a high level within the Blockhouse and no evidence of flooring or other internal features were recorded. The walls of the Blockhouse were founded directly on this bedrock which had been deliberately lowered to facilitate construction. The southern ends of the eastern and western walls of the Blockhouse were exposed below the northern perimeter wall, sitting on a concrete base directly on bedrock, informing the sequence of construction at this part of the Fort. The creation of the modern gravel path that runs along the outside of the northern perimeter wall of the Fort involved the removal of a large section of both the eastern and western walls of the Blockhouse. Finds were few but include both green and brown bottle glass and metal. An internal foundation trench for the northern and western walls of the Blockhouse, cut from close to modern ground level and down to the level of bedrock, was uncovered. The foundation regime of the building was investigated and imprints of the shuttering used to facilitate the pouring of the concrete for the walls were noted in the lower of the two fills that were contained within the foundation trench. A compact brown clay located at various points to level up the uneven bedrock was found to contain struck flint.

#### *The Blockhouse*

The Blockhouse was constructed of poured concrete blocks that were 0.30m thick. The building is pentagonal-shaped, a maximum of 8m long across the long, north-south, axis and a maximum of 6m wide



across the longest of its short, east-west, axis where the and eastern and western walls flared. At its short southern end, below the northern perimeter wall of the fort the blockhouse was 1.50 wide, east-west. The build appears to have been constructed in one episode and the wall was given a single context number (Context 5). Large sections of the western, northern and eastern walls survive above ground level. The walls of the Blockhouse survive to an internal maximum height of 1.8m. At the southern end of the Blockhouse, where the later northern stone perimeter wall of Grey Point Fort had been built over them, the walls of the building only survive as small stumps. No southern wall of the Blockhouse was observed either in Trench 1 A or in Trench 1B Northern Extension located directly in line with Trench 1A on the internal side of the stone perimeter wall of the Fort.

The underlying geology was basalt bedrock (Context 4) onto which the Blockhouse walls had been directly founded. The bedrock rose high within the Blockhouse but portions had, in fact, been cut away especially in the areas of the western and eastern walls of the Blockhouse were founded and possibly again when the modern path along the outside of the perimeter wall of the Fort had been created. The bedrock was irregularly shelved sloping down both to the north and south within the Blockhouse from its greatest height in the middle of the building. In the northern half of the Block house, and in patches of the southern half, a deposit of compact orange-brown clay (Context 3) had been laid down in what seems to have been an attempt to level up the surface perhaps prior to the construction of the Blockhouse. The clay contained large beach-rolled stones, that average 0.20-0.40m in diameter and several pieces of flint, some of which were struck and which may be prehistoric.

The foundations of the 20th century Blockhouse were cut through the redeposited clay onto the bedrock. The foundation cut (Context 7) for the walls of the Blockhouse was a recorded maximum depth of 0.50m and width of 0.42m. Internally the foundation cut had very steep straight sides and a flat bottom. No excavation took place external to the walls of the Blockhouse but the foundation cut would appear to have originally U-shaped in profile. The basal fill of the foundation cut was a thin layer of grey concrete (Context 9) which was a maximum recorded depth of 0.08m and lay against the inside face of the Blockhouse wall. It appears to be a spill over from the pouring of the concrete wall. The upper fill within the foundation cut was a deposit of grey-brown mortar dust and gravel stones up to 0.50m deep in places. Flint was recovered from this foundation fill. The imprint of the wooden shuttering used to pour the concrete for the Blockhouse walls was visible at various points along the top of foundation fill (Context 8).

No internal features or artefacts relating to the blockhouse were uncovered during the excavation. What might have been expected to have been uncovered would have been floor surfaces and small finds- either military materiel or personal items- dropped or discarded by the soldiers using the building.

#### *Other strata and features within Trench 1A*

Above the fills of the foundation trench, the orange-brown clay and bedrock was a layer of soil up to 0.20m deep that consisted of brown clay loam containing moderate quantities of small and medium-sized stones

many roots (Context 6). Presumably this was the old topsoil layer after the Blockhouse went out of use. Amongst the finds from topsoil were 20th century glass bottles and the end of a shotgun cartridge.

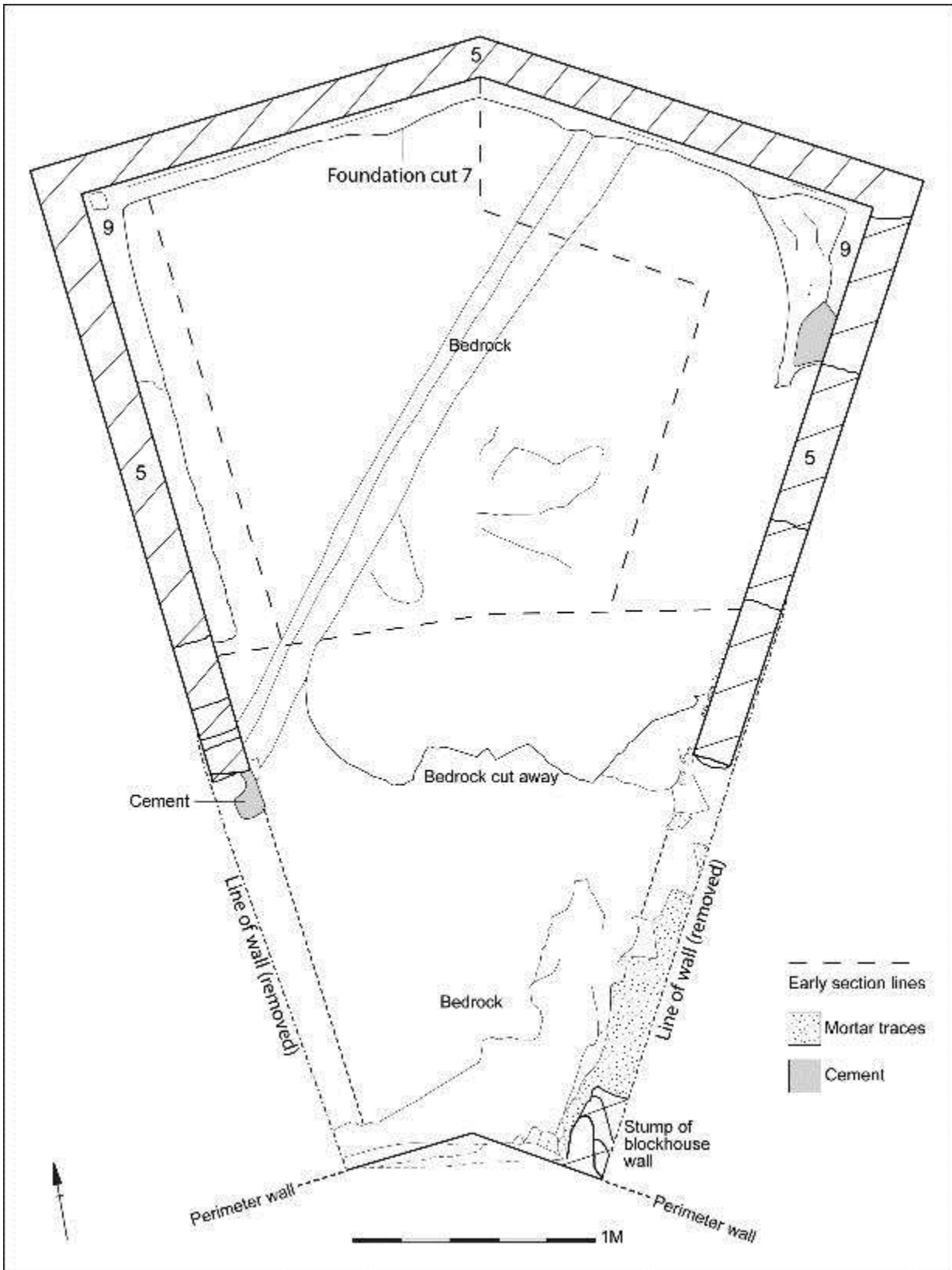

Figure 6. Trench 1A. Plan of the fully excavated Blockhouse.

Information about the construction of the northern perimeter wall of the Fort and the extra-mural path around it, both of which ran across and through the southern end of the Blockhouse, was uncovered during the excavation. Only the stumps of the western and eastern walls of the Blockhouse, lying directly underneath the base of the northern perimeter wall (Context 1029), survived the later episodes of activity at the southern end of the Blockhouse. Where the later stone perimeter wall of the Fort was built over the southern end of the two main walls of the Blockhouse no southern wall of the Blockhouse was visible or identified during the excavation. Two deposits of poured concrete, the lower one a maximum of 0.40m thick, the upper one 0.15m thick, had been deposited over the underlying uneven bedrock between the stumps of the Blockhouse walls to create a level surface. On top of these two poured deposits and between the stumps of the Blockhouse wall a concrete lintel that was 1.50m long and 0.20m high had been inserted, and this was the level base on which the northern stone perimeter wall of the Fort was founded. The external face of the perimeter wall at the south of Trench 1A was 1.15m high on top of which metal railings are now inserted. Directly in line with the southern end of Trench 1A on the other side of the stone perimeter wall of the Fort was the location of Trench 1B Northern Extension.

At the southern end of the Trench 1A an approximately 3m stretch of both the eastern and western wall of the Blockhouse had been removed to facilitate the construction of the extra-mural path. This construction also involved the lowering of the underlying bedrock to the required level of the path and much chipped bedrock was found directly over bedrock proper in the south of the site. The path consisted of a layer of compact grey gravel (Context 2) up to 0.30m deep and was laid directly over the old topsoil layer (Context 6) in the area of the path. Above this was the modern topsoil layer (Context 1) that was a dark brown silty loam with occasional small to medium angular stones and frequent roots.



**Plate 7. Trench 1A. The internal area of the Blockhouse excavated to the level of bedrock. From the south.**



**Plate 8. Trench 1A. The internal area of the Blockhouse excavated to the level of bedrock. From the north. At the top of the photograph the stumps of the eastern and western walls of the blockhouse are visible below the later northern stone perimeter wall of the Fort.**



**Plate 9. Trench 1A. The southern end of trench showing the stumps of the western and eastern walls of the Blockhouse and the later northern stone perimeter wall (C.1029) of the Fort built over these. Between the Blockhouse walls layers of poured concrete and a concrete lintel were used to level up the uneven bedrock and provide a firm base for the perimeter wall.**



**Plate 10. Trench 1A. The fully excavated Blockhouse from the south-west. At the far left of the shot the later northern stone perimeter wall of the Fort is visible. Also visible are the modern gravel path and the section of bedrock and the sections of the western and eastern walls of the Blockhouse which had been removed to facilitate the creation of the path.**

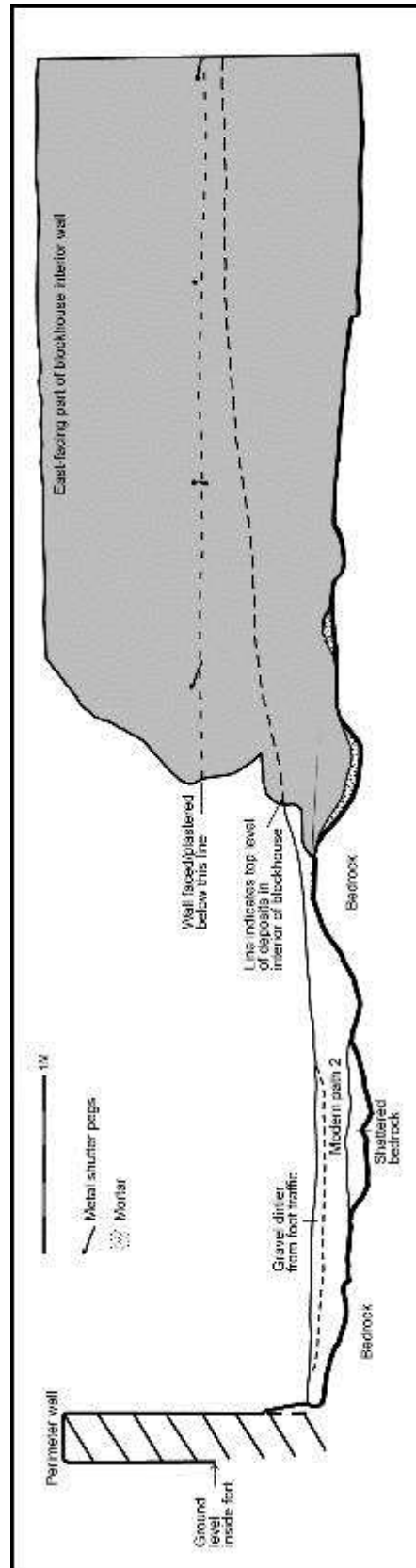

Figure 7. Trench 1A. East-facing profile of the Blockhouse, showing the western wall of the building and the later northern stone perimeter wall of the Fort and the associated extra-mural gravel path. Note the drop in the level of the bedrock, where it had been deliberately removed, in the area of the path.

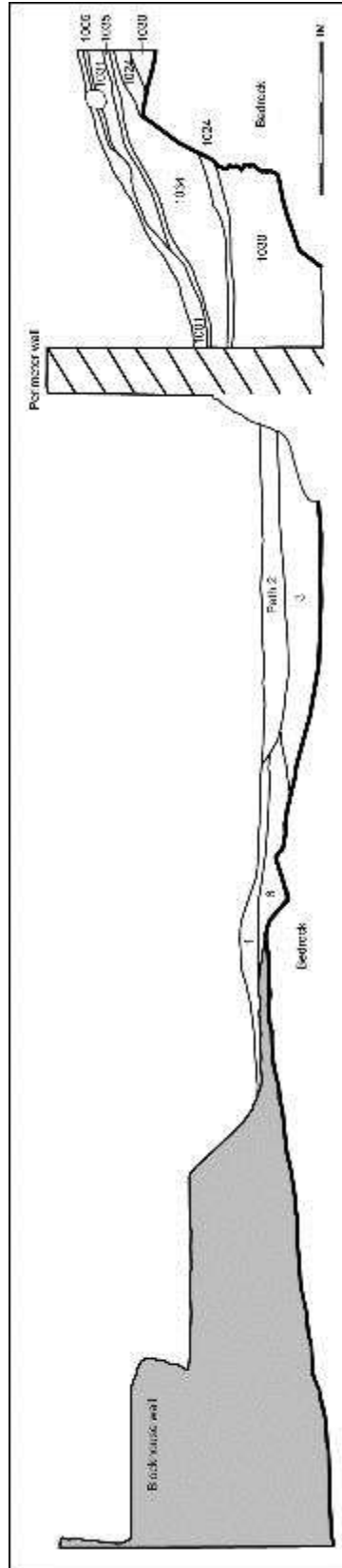

Figure 8. West facing profile through Trenches 1A and 1B Northern Extension showing the eastern wall of the Blockhouse, the later northern stone perimeter wall of the Fort and the associated extra-mural gravel path. Note the drop in the level of the bedrock, where it had been removed in the area of the path and also immediately south of the perimeter wall.

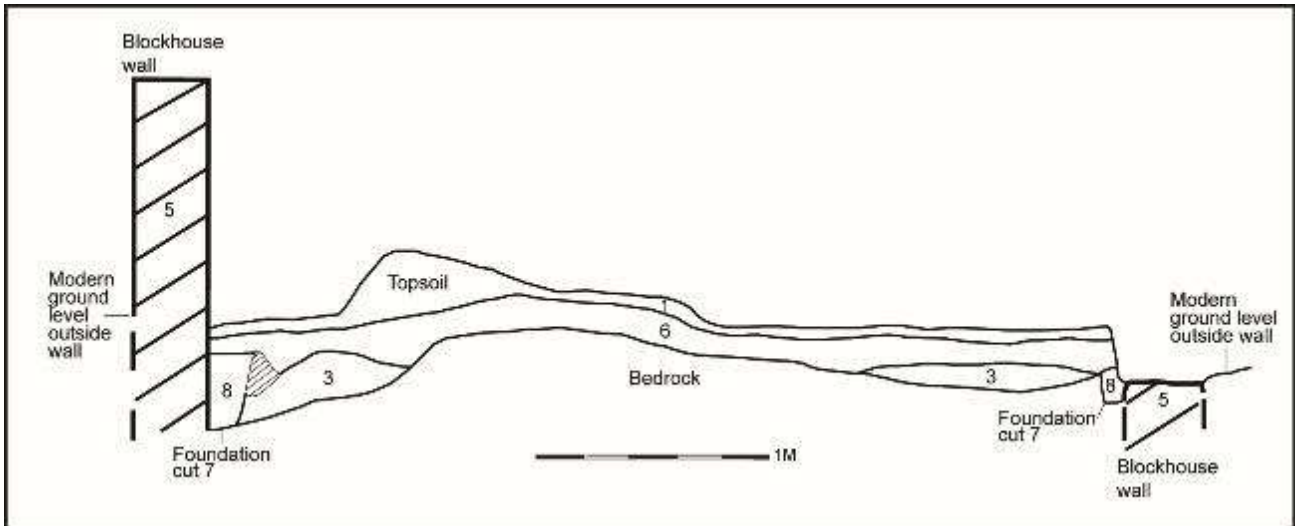

Figure 9. Trench 1A. South-facing section across the middle of the Blockhouse.

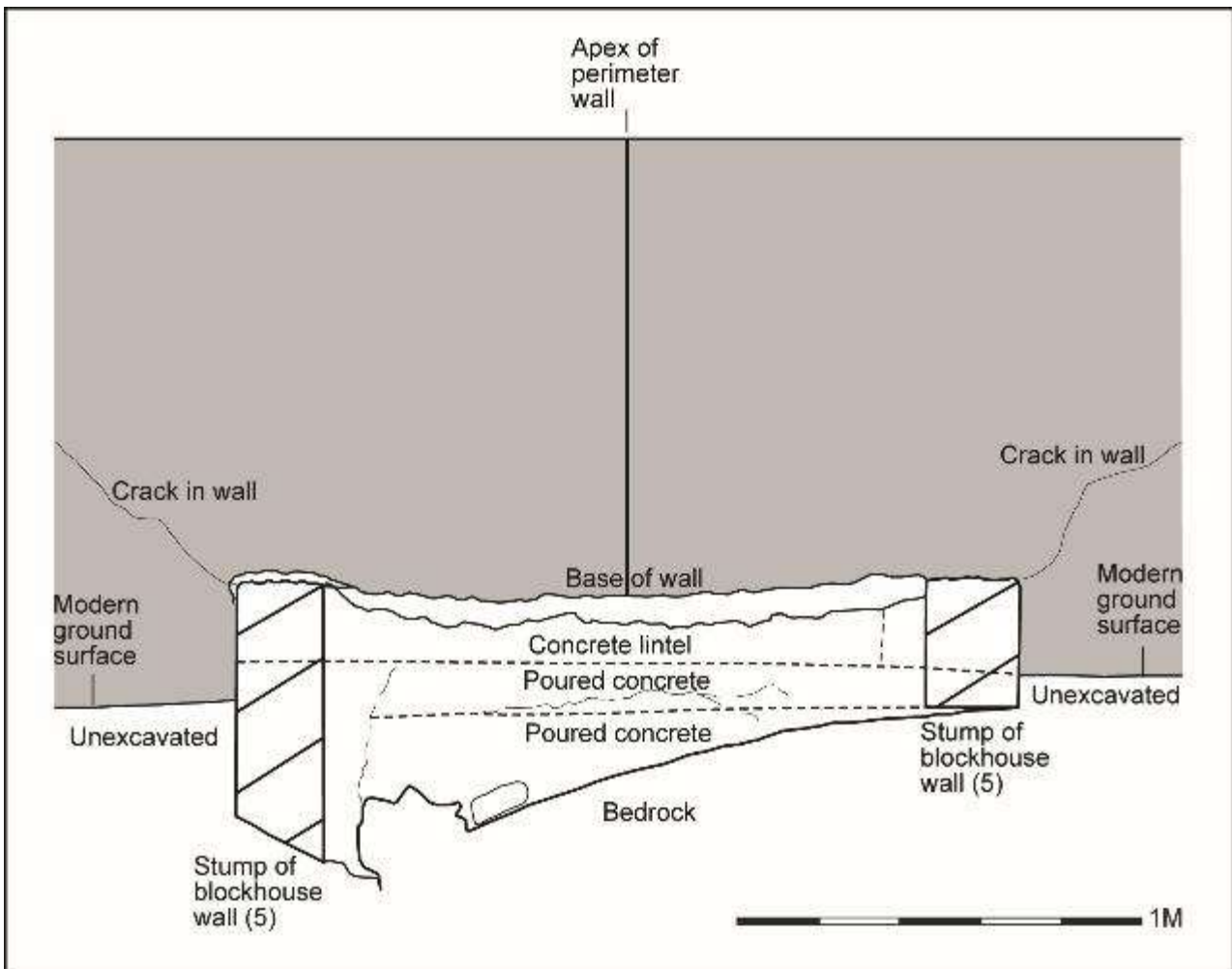

Figure 10. Trench 1A. North-facing section at the southern end of trench showing the stumps of the western and eastern walls of the Blockhouse and the later northern stone perimeter wall of the Fort built over these. Between the blockhouse walls layers of poured concrete and a concrete lintel were used to level up the uneven bedrock and provide a firm base for the perimeter wall.



### 3.4.2 Trench 1B

Trench 1B was a segmented trench located immediately south of the internal apex of the northern stone perimeter wall of the Fort, on the grassed area adjacent to the slope below the gun emplacements. It was also in line with Trench 1A on the other side of the perimeter wall. The central main trench was roughly 4m long, north-south, x 2m, east-west. It was later extended to the north (Trench 1B Northern Extension) and Trench 1B (Southern Extension) with baulks left between all three trenches for health and safety reasons and to facilitate access around this part of the Fort.

The Northern Extension was excavated to investigate the presence or absence of structural features relating to the earlier Blockhouse in the environs of the later Fort perimeter wall. The purpose of the Southern Extension was to investigate the potential location of an earlier perimeter wall of the Fort.

#### **Trench 1B main trench** (Figures 11-14; Plates 11-13)

There was a maximum of 0.95m of stratigraphy encountered in the main Trench 1B. The underlying geology in the trench was uneven and shattered bedrock. Directly above this in the north of the trench was a layer of dark grey-brown silty loam (Context 1019) that was up to 0.20m thick. It appears to reflect the natural silting up of the northern end of the trench and it was here that most of the water accumulated after rainfall. Above bedrock in the southern end of the trench was a similar grey-brown clay loam (Context 1020). However, this layer also contained fragments of red brick and concrete and it may represent the deliberate infilling and levelling of the uneven surface of the bedrock with material that included building rubble.

Above these two layers were, at the northern end of the trench, a layer of redeposited orange subsoil clay along with fragments of concrete, lumps of burnt clay and sub-rounded stones (Context 1021). This localised layer was up to 0.18m thick appears to have been another dumped layer. Above this, and encountered across the whole trench was a more substantial layer of dumped material (Context 1017) that was up to 0.40m deep. The deposit was mottled and a loose mixture of clay, sand, silt and loam. It contained large fragments of reinforced concrete blocks, angular stones, red brick, coal, glass and slag. The deposit seems to be a concerted effort to raise the ground level in this part of the Fort, possibly to create a level surface as part of the works associated with the creation of the pre-WW1 coastal battery. It was into this level that two iron trench pickets (Contexts 1013A & 1013B), discussed below, had been driven. In fact one of the fragments of concrete had an impression in it that perfectly fitted the dimensions of the fence pickets and may be the base of such a defensive structure.

Above these, at the southern end of the trench, was a localised dumped deposit up to 0.35m deep of re-deposited keuper marl subsoil clay containing some concrete and small sub-angular stones (Context 1009). This, in turn, underlay a layer of orange-brown mix of sandy silt and clay (Context 1016), up to 0.20m thick, which contained flint and sub-rounded stones. Above this was another thick deposit of orange-brown sandy loam (Context 1011) containing fragments of reinforced concrete, corroded iron and medium-sized angular stones. It was up to 0.30m deep. It could reflect a deliberately laid down surface to stabilise the two iron fence pickets (Contexts 1013A & 1013B) when they had been inserted into Context 1017.

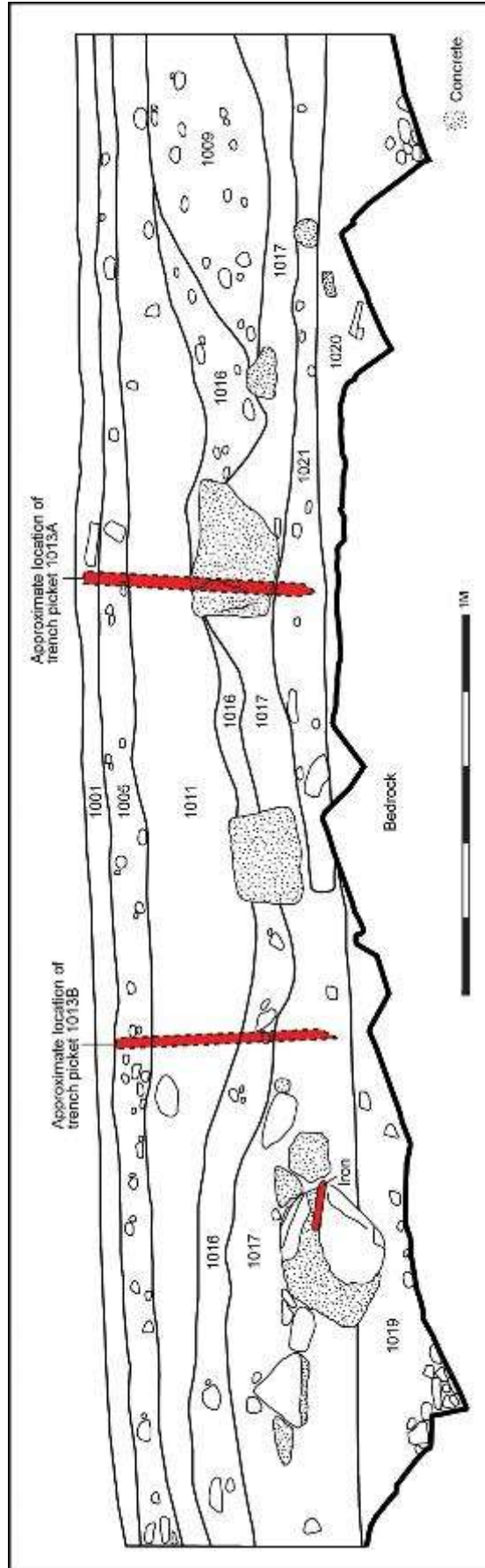

Figure 11. Trench 1B, main trench. West-facing section.

The two trench pickets were 1.34m apart. They were both roughly 0.70m long, L-shaped in section with both sides measuring 0.045m. The trench pickets were exposed in topsoil (Context 1001) just centimetres below the grass that now constitutes modern ground level on the terrace below the Fort guns. It is probable that the tops of the fence pickets were cropped (sawn) after the barbed wire defensive fence around the Fort, of which they were a part, was dismantled and replaced by the stone perimeter wall. Topsoil (Context 1005) below the grass and above the stabilising layer (Context 1011) was a mid-brown loam out of which were recovered struck flint, fragments of barbed wire, corroded iron objects and butchered animal bone.

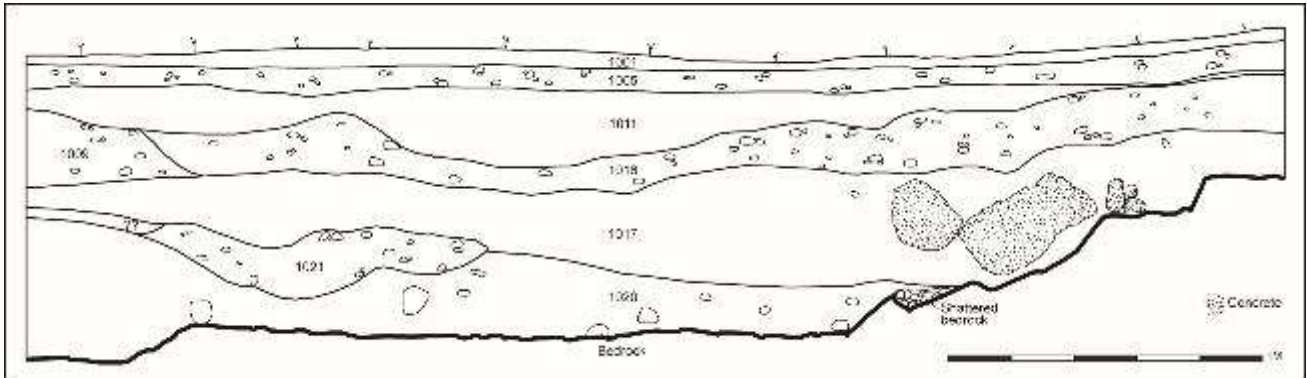

Figure 12. Trench 1B, main trench. East-facing section.

Two further parallel trenches either side (east and west) of the main Trench 1B, 1m wide and with a 0.50m baulk between them and the main trench, were used for supervised excavation experience by a variety of schools that visited the excavation in the second week. Neither trench was excavated below the topsoil horizon but two further iron trench pickets, in line with those uncovered in the main Trench 1B, were exposed in the western one. Again, these would also appear to have been cropped to ground level after the barbed wire defences were replaced by the stone perimeter wall.

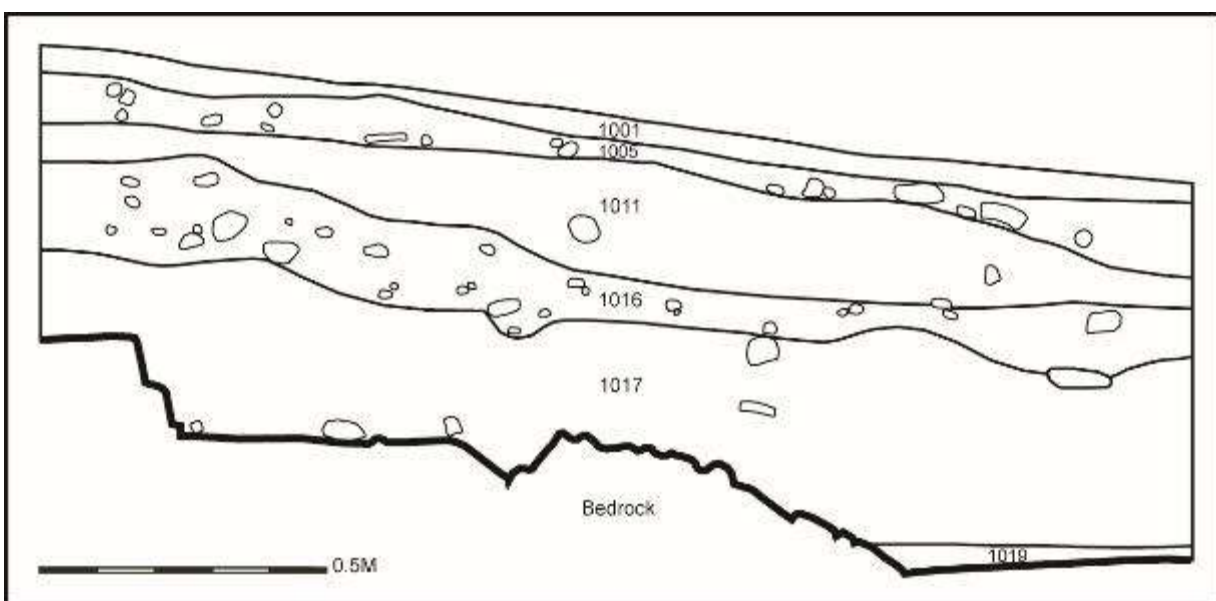

Figure 13. Trench 1B, main trench. North-facing section.

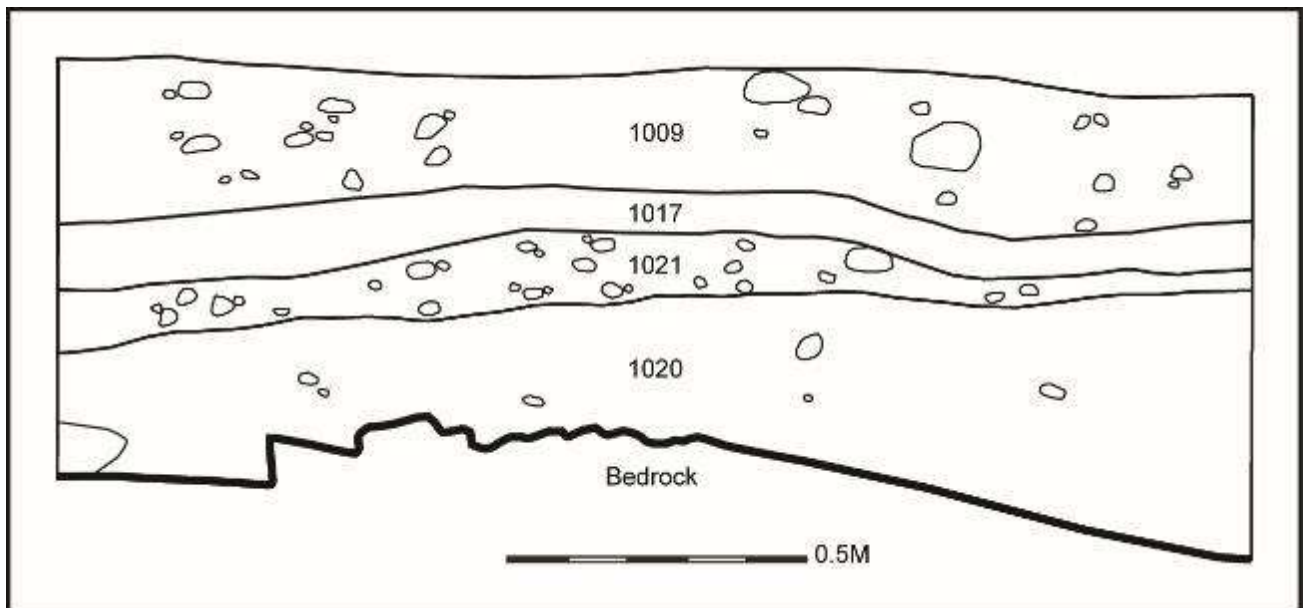

Figure 14. Trench 1B, main trench. South-facing section.



**Plate 11. Trench 1B, main trench. Iron fence pickets C.1013A and C.1013B, to right of shot, during excavation. From the South.**



**Plate 12. Trench 1B, main trench fully excavated to the level of bedrock. From the South.**



**Plate 13. Trench 1B, main trench. North-east corner. Detail of fragment of concrete in C. 1017 with an impression and portion of iron fitting that matches the dimensions of the excavated fence pickets and which may have been a base of such a defensive structure.**

**Trench 1B Northern Extension** (Figures 15-16; Plates 14-15)

Trench 1B Northern Extension was the extension of main Trench 1B to the north, separated by the main trench by a 1m wide baulk. The trench was 2m by 2m. The northern limit of the trench was the inner face of the apex of the northern stone perimeter wall of the Fort which also separated it from the southern end of Trench 1A.

As elsewhere in this part of the Fort, the underlying geology was bedrock (Context 1018). It is clear from the excavation that the original level of the bedrock and the subsoil above it (Context 1027) had been lowered at the northern end of the trench to create a foundation trench in preparation for the construction of the northern stone perimeter wall (Context 1029) that replaced the barbed wire emplacements further south as the primary line of defence for the complex of buildings that make up Grey Point Fort.

The construction regime of the northern stone perimeter wall involved a number of facets. At the apex of the northern perimeter wall an internal stone buttress (Context 1037) was incorporated into the build, as elsewhere along various points on the perimeter wall circuit. The buttress took the form of a stone column that projected out from the main wall but was also an integral part of it.

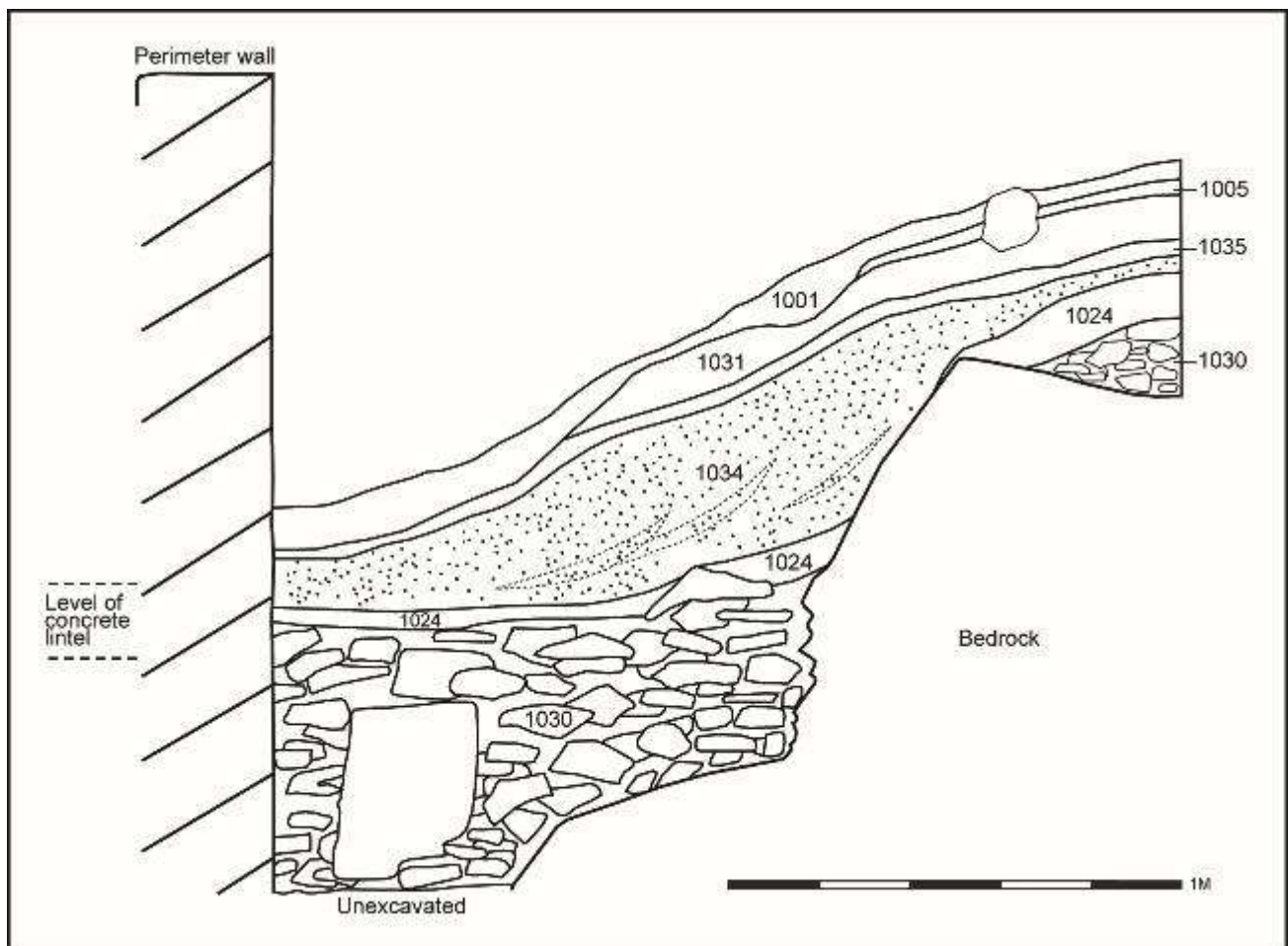

Figure 15. Trench 1B, Northern Extension. West-facing section.

*The northern stone Perimeter Wall of the Fort in Trench 1B Northern Extension*

Where the buttress projects out from the internal apex of the perimeter wall a stone lintel had been laid and where the buttress abuts the apex of the perimeter wall both the wall and internal buttress sit upon this lintel. Beyond (south) of the surface of the lintel a thick layer of concrete, up to 0.25m deep, had been laid over the bedrock and the southern end of the buttress sits on this surface. The build-up of concrete may also have been necessary to create a level surface for the construction of the perimeter wall as the bedrock on this part of the Fort had already been lowered to facilitate the construction of the Blockhouse. On either side of the buttress the bedrock had been cut into and lowered, and the stone perimeter wall to the east and west are founded deeper than at the apex. Many of these same construction facets were visible on the external face of the wall and were also recorded in Trench 1A (see above).

If the construction regime used for the apex of the stone perimeter wall had been chosen to deal with the removal of an earlier southern wall of the Blockhouse investigated in Trench 1A, no evidence of that building was found within Trench 1B Northern Extension. Nor was any evidence uncovered within the trench that the Blockhouse had been originally been open to the south and access to it was by means of some sort of stairs or egress from the terrace below the Fort guns.

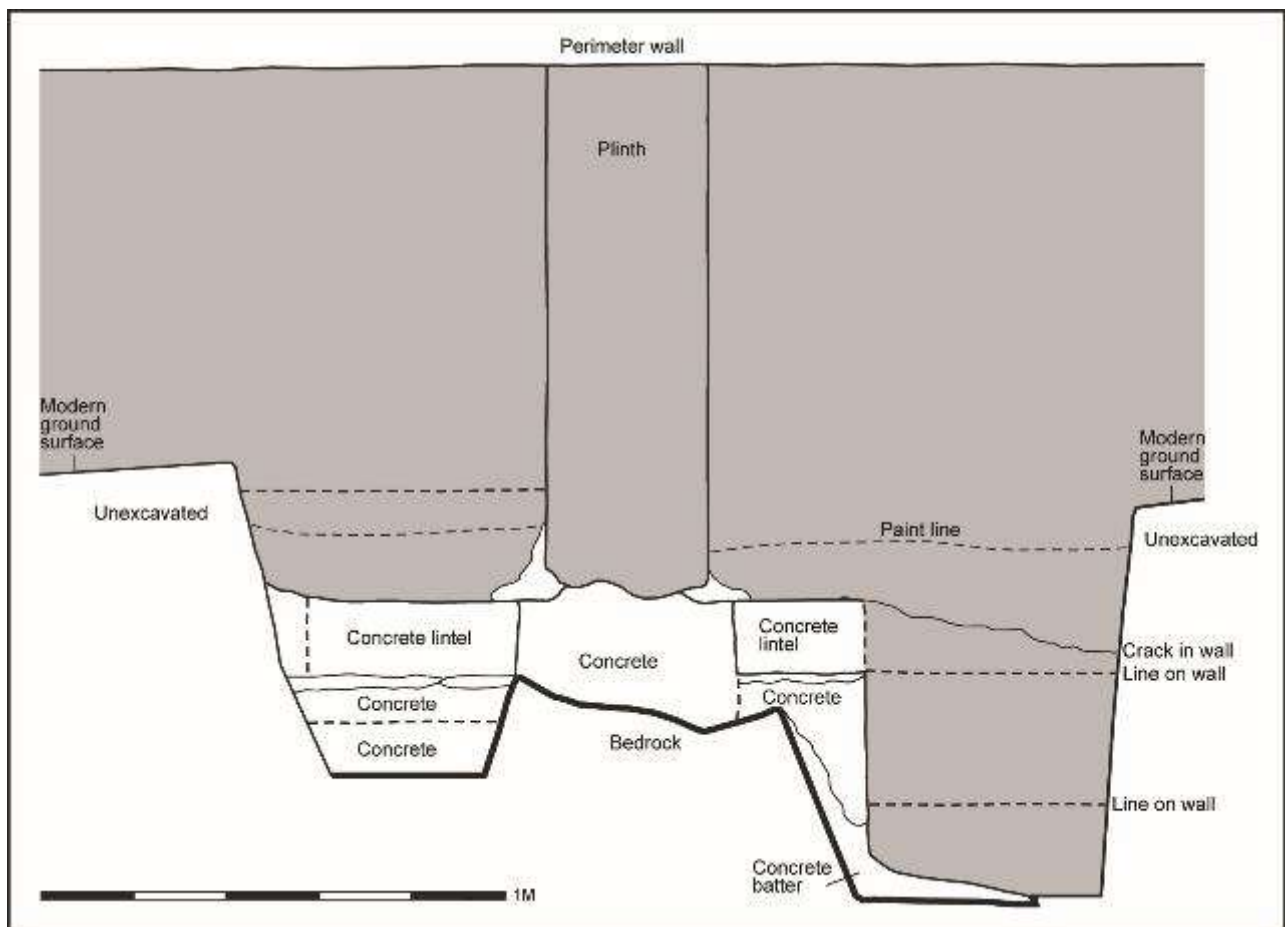

Figure 16. Trench 1B, Northern Extension. West facing section.



Elsewhere in the trench directly above bedrock was a deep layer of shattered bedrock and loam (Context 1030), up to 0.60m thick that was the primary fill of the foundation trench. It had been deposited from the west and was deeper in the eastern half of the trench. The fill was a mixture of small, medium and very large broken bedrock and was presumably the material that had been removed during the digging of the foundation trench for the perimeter wall, stored close by and thrown back in after the wall had been inserted.



**Plate 14. Trench 1B, Northern Extension. South-facing section, showing the later stone perimeter wall of the Fort founded on the concrete lintel and layers of poured concrete and the drop in bedrock where this has been removed. In the background of the shot is Trench 1A/ the concrete Blockhouse over which the stone perimeter wall had been built.**

Above was a thin layer of brown loamy clay (Context 1024) which may reflect a layer of relict topsoil which accumulated after the northern perimeter wall was constructed. This, in turn was covered by layers of sand, loam and gravel (Contexts 1023, 1031, 1033 and 1034), perhaps material left over from works at the Fort, including the creation of the modern gravel path (Context 1002) uncovered in Trench 1B southern extension (see below) dating to the 1970s or 1980s.



**Plate 15. Trench 1B, Northern Extension. West-facing section showing the later stone perimeter wall of the Fort founded on the concrete lintel and layers of poured concrete. The drop in bedrock where this has been removed is very visible as are the later dumped layers of gravel and sand.**

#### **Trench 1B Southern Extension** (Figure 17; Plates 16-17)

Trench 1B Southern Extension was the southern extension of Trench 1B, separated from the main trench by a 2m wide baulk. The trench was 2m long, east-west, x 1.5m long, north-south. There was a maximum depth of 1.15m of stratigraphy within the trench above bedrock (as elsewhere Context 1018).

As in the main trench, the earliest strata appear to relate to early 20th century attempts to level up the bedrock as part of the preparation of the ground for the erection of the Fort. This took the form of a dumped mixture of shattered bedrock, stones and lumps of concrete of various sizes. This was especially visible in the western

half of the trench. Above bedrock in the west of the trench was a mottled layer made up of lenses of grey-brown sandy loam and orange clay (Context 1026) and in the south-west corner a dump of large stones and fragments of concrete. Above this was a deep dumped deposit of brown loam (Context 1025), up to 0.55m thick, the primary stratum within the trench. This may be the same stratum as Context 1017 in the main Trench 1B.

Above it were a series of smaller dumped deposits including a mottled orange clay (Context 1038 = Context 1009 in main Trench 1B), and a modern gravel path (Context 1002) oriented east-west and within a cut (Context 1006) which had been inserted through (?1970s) topsoil (Context 1005). The path either relates to when the Fort was included in Crawfordsburn Country Park in 1971 or else, like in Trench 2, when works were carried out at the Fort in the 1980s. The path allowed safe access along the grass terrace below the Fort guns.

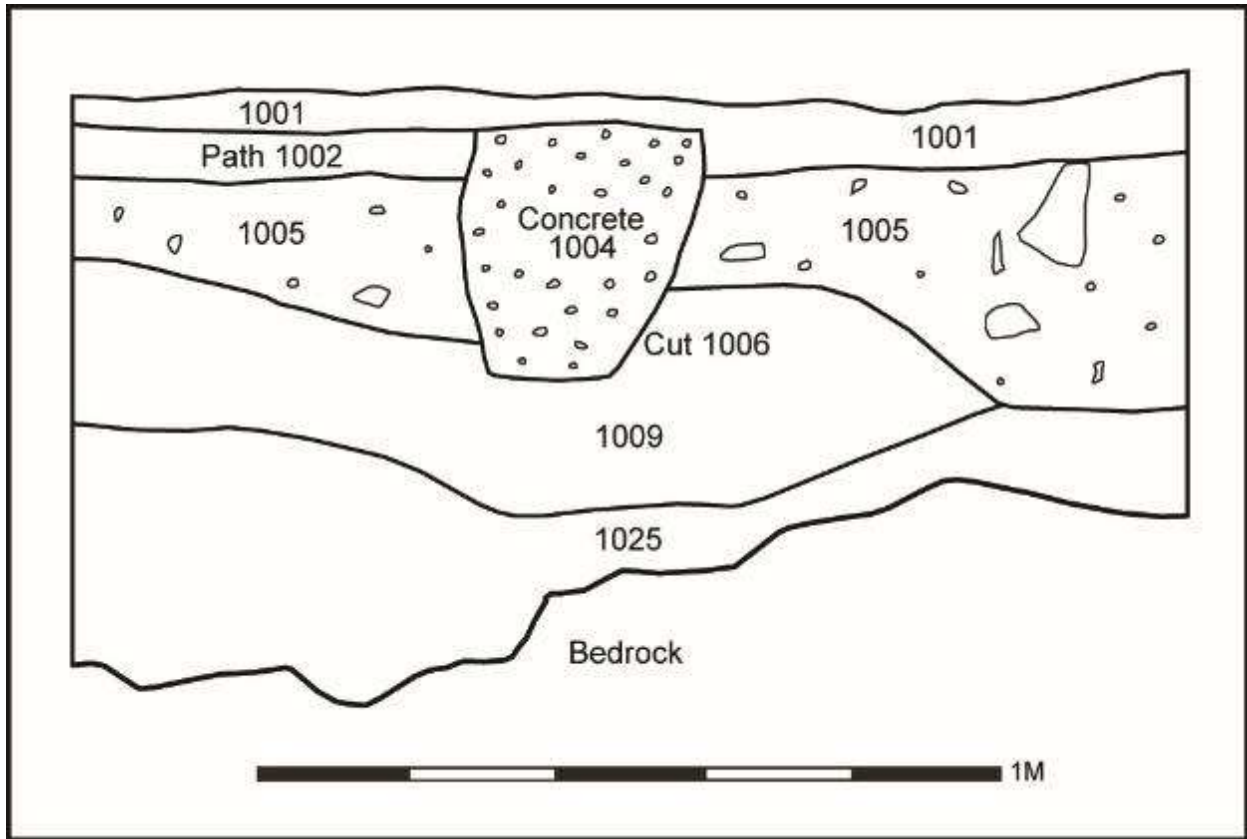

Figure 17. Trench 1B, Southern Extension. West-facing section.



**Plate 16. Trench 1B, Southern Extension. West-facing section.**



**Plate 17. Trench 1B, Southern Extension. South-facing section.**

### 3.4.3 Trench 2 (Figures 18-20; Plates 18-19)

Trench 2 was located parallel and outside (2.5m west of) the line of the western stone perimeter wall of the Fort, 33m north of its south-west corner. It measured 7m long, north-south, x 2m wide, east-west. On the advice of a NIEA structural engineer the trench was excavated in two halves to reduce the potential hazard of undermining the perimeter wall. To this end, the adjacent perimeter wall was shored up and the trench enclosed in scaffolding for the duration of the excavation. The underlying geology in the trench was basalt bedrock covered by sandy orange-yellow keuper marl subsoil clay (Context 210). Directly above this was a layer of mid-brown sandy and silty loam with a moderate quantity of small-medium sized stones and frequent roots (Context 205) and it may represent a relict topsoil horizon.

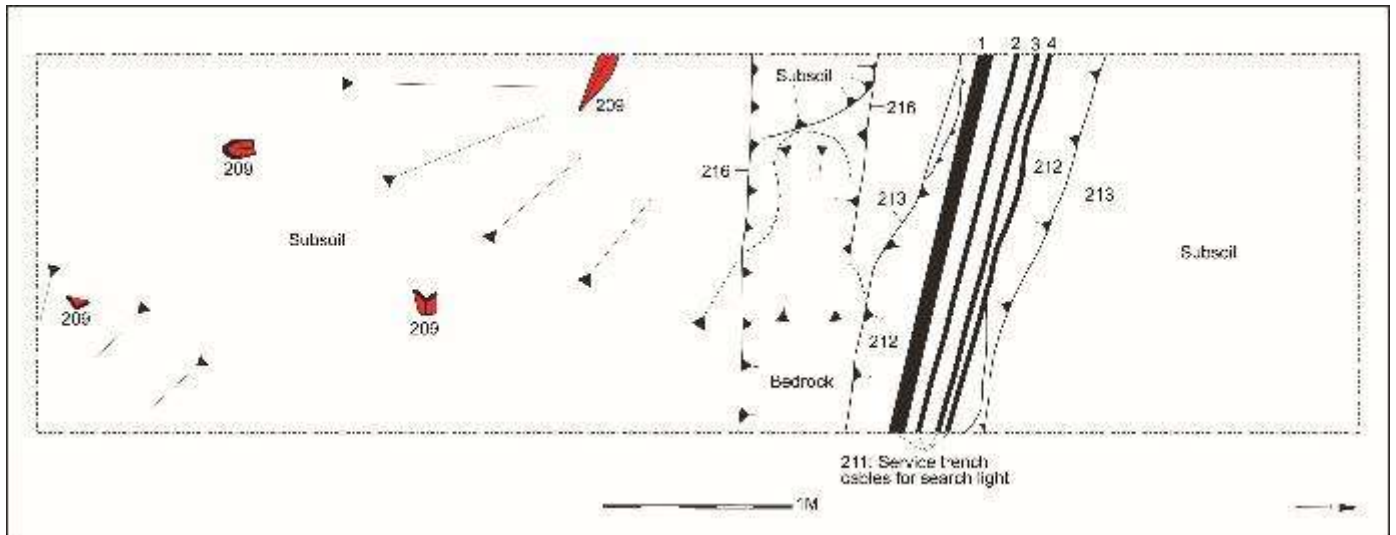

Figure 18. Trench 2. Plan of main features- the remains of the iron fence pickets (in red) and the later electricity cables that ran in the direction of the most westerly of the coastal searchlight emplacements.

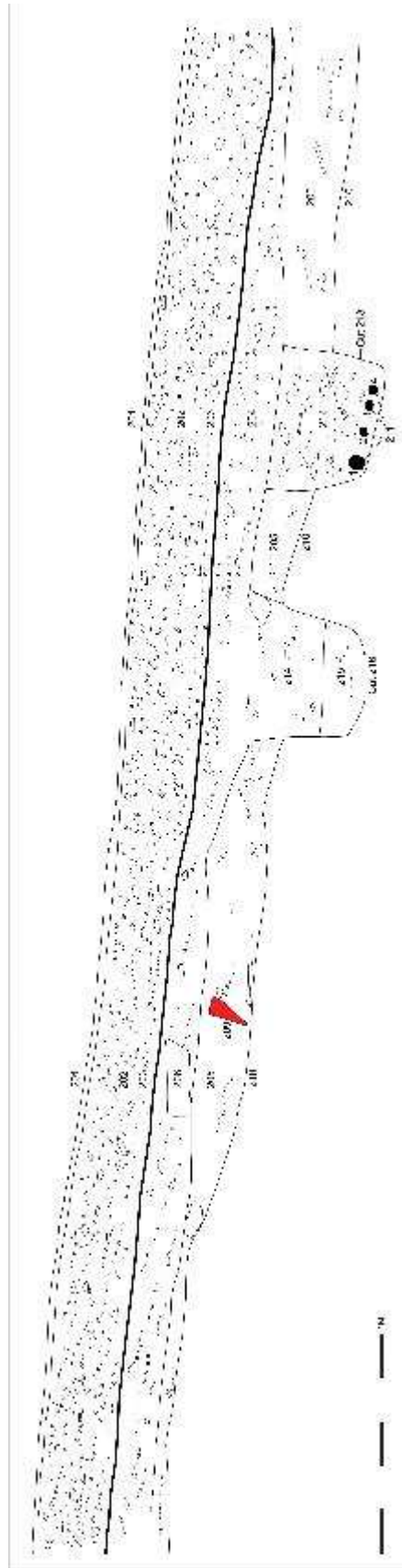

Figure 19. Trench 2. East-facing section showing one of the iron trench pickets (C.209), the cuts for the service cables to the most westerly of the coastal searchlight emplacements (C.213 and C.216) and the later gravel paths (C.202 and 204).

Cut through the silty loam into subsoil were a number of features relating to the Fort when it was active. The first of these were two parallel cuts (Contexts 213 and 216) oriented roughly east-west that ran across the trench towards its northern limits. The most southerly of the cuts (Context 216) was 0.63m wide and varied in depth from 0.15m-0.46m. The basal fill (Context 215) was a mid-brown silty loam up to 0.20m deep. The upper fill (Context 214) was a mottled orange-brown clay loam.

The more northerly of the two cuts (Context 213) was located immediately adjacent to the first. It was 0.80m wide. The basal fill of the cut (Context 212) was a mid-brown silty loam with a very high content of medium-sized angular stones. The main fill of the cut was five metal cables (Context 211) which varied in diameter from 0.05m to 0.02m. Because of the presence of the cables the feature was not fully excavated.

Both of the cut features were electricity service trenches and the cables in the most northerly one were a section emanating from Grey Point Fort to the most westerly of the three coastal searchlight emplacements (Defence Heritage Record No. 316) positioned close to the fortification. It may be that the more southerly of the two cuts (Context 216) may have been a first, failed, attempt to facilitate the cables in a service trench and the adjacent cut (Context 213) was a second, successful, one.

Also inserted through Context 205 into subsoil were four iron fence pickets (Context 209) located in the southern half of the trench. These were 0.04m square in section and varied in length between 0.23m and 0.35m. The fence pickets were sited roughly 1.20m apart and they seem to represent a zigzag alignment of posts which would have held barbed wire entanglements and would have constituted one of the early peripheral defensive fortifications around the Fort. Like those in Trench 1B, the trench pickets appear to have been cropped to ground level after the barbed wire was replaced by the stone perimeter wall.

Above these was a layer of broken concrete slabs (Context 206) sitting on the old topsoil surface (Context 205). This rubble horizon may represent a phase of abandonment when the Fort went out of use.

A number of other later features were uncovered in the trench that probably also date to after the Fort was decommissioned in 1956. These include two separate compacted gravel paths (Contexts 202 and 204), alongside the western fort perimeter wall, and a drain (Cut Context 207; fill Context 208). The earlier path (Context 204) was composed of coarse gravelly stones and was 2m wide. The drain cut was roughly 0.70m wide and was filled with small loose gravel. It was presumably inserted to facilitate the drainage of the path. Both the path and drain may date to when Grey Point Fort was incorporated into Crawfordsburn Country Park in 1971.

Above the drain and path was a layer of industrial textile (terram) which was the base for the current path (Context 202) around the outside of the Fort along its western perimeter. The path, again constructed of gravel and quarry dust, was 2m wide and between 0.09-0.33m thick. It probably dates to works carried out at the Fort in the 1980s.

Finds from Trench 2 included barbed wire, iron nails and metal objects, and Post-Medieval pottery (Creamware and Brown and Red Glazed Earthenware). Residual prehistoric struck flint was also uncovered from the modern contexts.

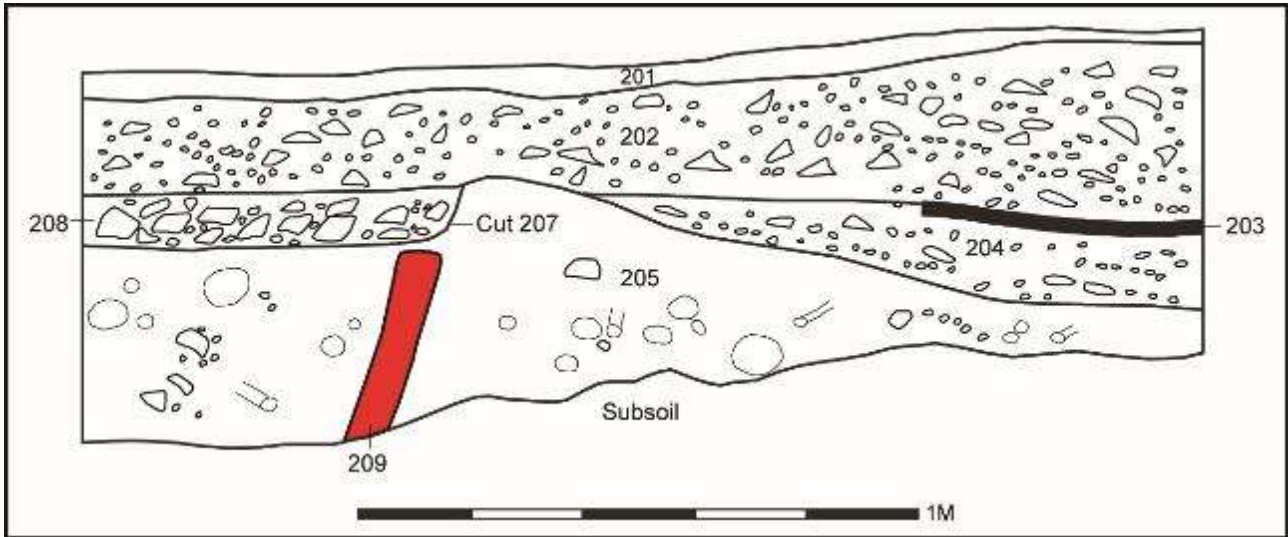

Figure 20. Trench 2. North-facing section showing one of the iron trench pickets (C.209) and the two later gravel paths (C. 202 and C. 204).



Plate 18. Trench 2 from the East. Detail of the two service trenches (C. 216 and C. 213) and the service cables (C. 211).





**Plate 19. Trench 2 from the North. Trench excavated to subsoil level with the stumps of four iron fence pickets in the foreground and the later service trench with the service cables in the background.**

#### **3.4.4 Introduction to Trenches 3 and 4**

Trenches 3 and 4 were excavated to investigate aspects of the earthen fortifications that make up the early 20th century shoreline defences outside the Fort. Some of these may have been also used as practice trenches to get troops used to trench warfare before they were sent off to fight in mainland Europe in 1914-1918. The aim of the two investigations was to assess the level survival of the features, to determine their original dimensions and to try to obtain dating evidence for their construction and use. The two trenches were excavated in extremely inclement weather in late October and November 2014.

#### **3.4.5 Trench 3 (Figures 21-25; Plates 20-23)**

Trench 3 was located across a section of one of the early 20th century earthen shoreline defences, 35m south of the concrete path that led to the 1936 eastern searchlight emplacement (Defence Heritage Record No. 317). This modern path dissected the most forward of the earthen shoreline earthen trench defences around Grey Point Fort. The research design here was to remove modern vegetation and overburden to uncover the original dimensions of this section of the fortification and gather internal details about construction and layout.

The excavated portion of the earthen shoreline defensive trench was 5m long, east-west by 2m wide, north-south section. The earthen trench was found to be a maximum of 1.30m high on its western side and 1m wide, internally. The landscape drops away to the east down to the shore and this is reflected in the drop of the differing levels of subsoil on either side of the trench. The section excavated overlooked an inlet on the shore. The subsoil in the western bank is 0.40m higher than under the eastern bank. The fortification was cut into the subsoil, which in this area of the site was orange-brown keuper marl clay. Above subsoil on the western bank of the trench was a light brown clay (Context 305), up to 0.30m thick, with many roots and some small stones. Above subsoil in the eastern bank was a layer of light brown clay (Context 304) also with a high root content, up to 0.25m thick.

The earliest feature encountered within the trench was a roughly-cut drain (Context 309) that was uncovered running down the middle of the base of the trench almost to the northern limit of excavation. The drain was 0.20m wide and 0.10m deep. It was filled with a dark brown silty clay (Context 310) that contained moderate amounts of small stones.

Close to the northern limit of the excavation the drain widened and it curved to the north-east before feeding into a larger, irregularly shaped, dry stone drain (Context 303) which had been cut into the eastern bank of the defensive trench. This larger drain was 1m high and between 0.50-0.60m wide.

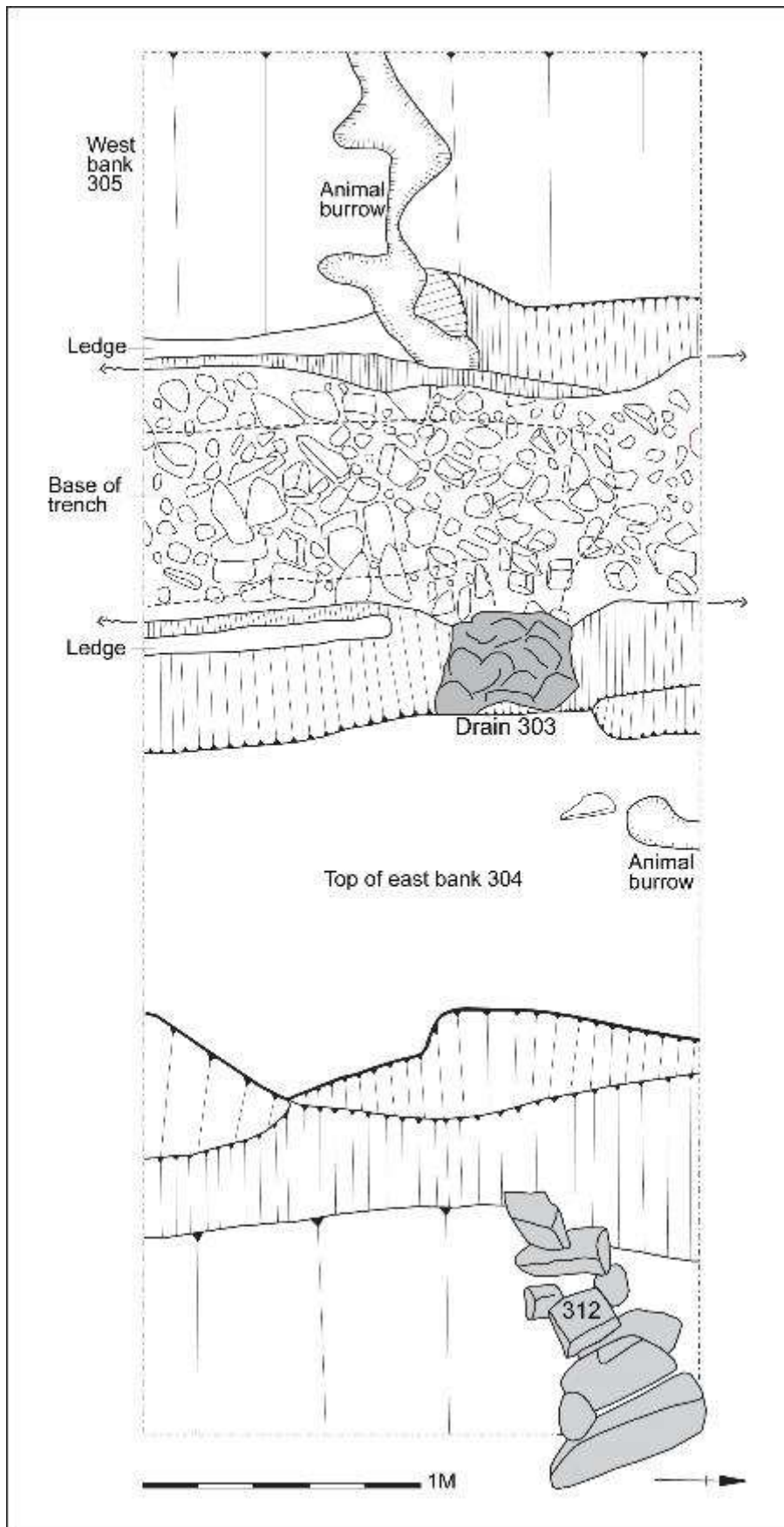

Figure 21. Trench 3. Plan of earthen shoreline defensive trench showing the stone surface (C.306/307) in the base of the trench and the drain (C.303/312) built into the eastern bank.

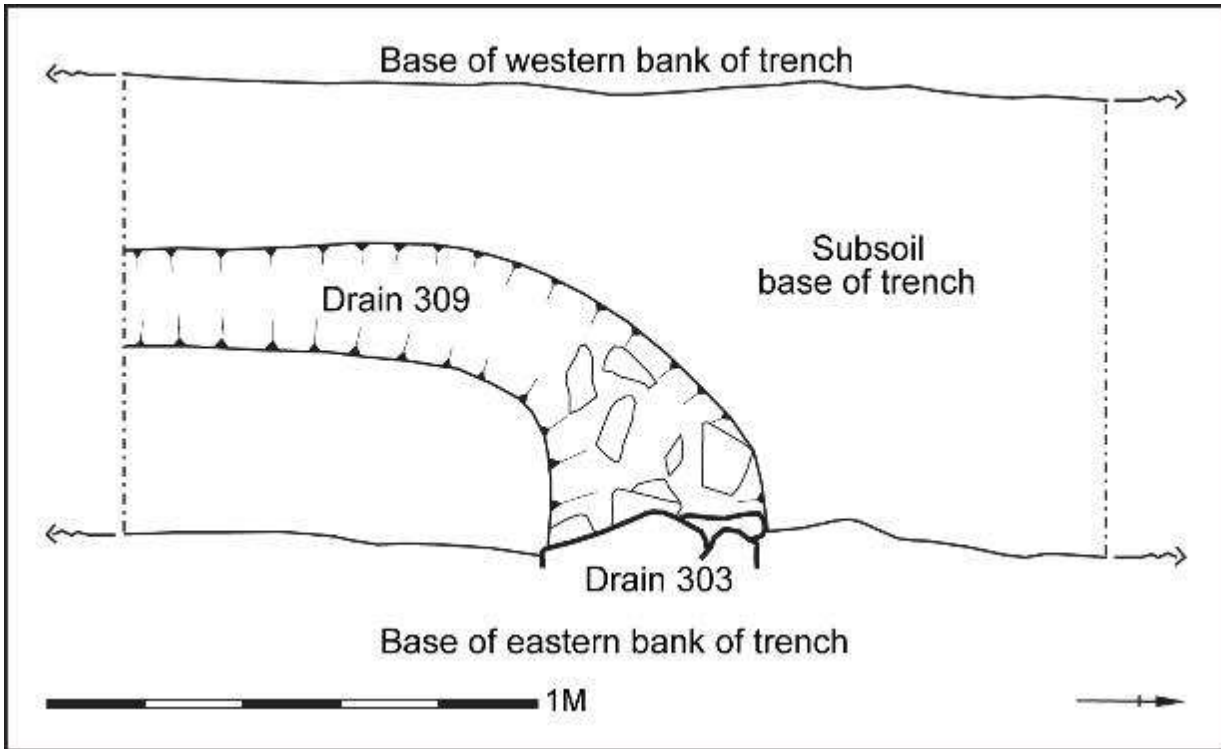

Figure 22. Trench 3. Plan of subsoil-cut drain (C.309) in the base of the earthen shoreline defensive trench and the larger drain (C.303) built into the eastern bank of the defence.

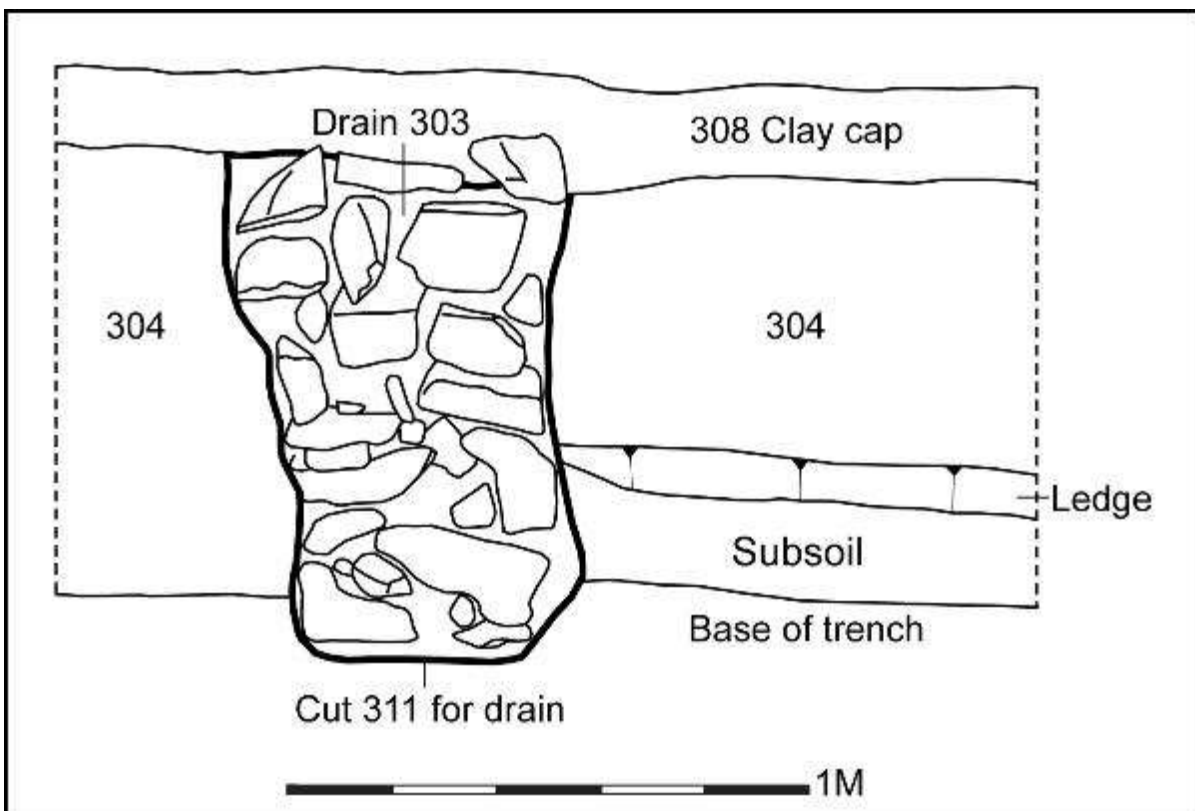

Figure 23. Trench 3. West-facing section across the eastern bank of the earthen shoreline defensive trench showing the drain (C.303) built into the bank and which linked up with the smaller subsoil-cut drain (C.309) in the base of the trench.

It was constructed of a mixture of large and medium-sized stones with no clearly definably coursing evident in the build. The drain and top of the eastern bank of the trench were capped with a layer of mottled orange-brown clay (Context 308) that appears to have been a mixture of re-deposited subsoil and soil, and it was up to 0.20m thick. This was the top of the bank on this side of the trench. Water was conveyed out of the base of the trench through the eastern side of the eastern bank of the trench via a smaller dry stone drain (Context 312), composed of large and medium-sized stones, which was uncovered for a distance of 1m east of the fortification. This section of the drain was recorded (Figures 20, 24; Plate 23) but as it lay beyond the limits of excavation no further archaeological investigation was carried out.

The drain was clearly necessary to remove water from this section of the trench which seems to have been prone to flooding due to its low-lying location. Why it did not continue along the whole length of the base of the earthen shoreline defensive trench/ practice trench base is uncertain. It could be that there were further drains at various points along the whole length of the fortification beyond that portion archaeologically investigated in 2014. Once the drain was exposed during the excavation and modern silting removed it was found that the feature was still functioning efficiently a century after it has been constructed and the water that had gathered in the base of the trench because of the heavy rain that fell during the period of the 2014 excavation was conveyed out of the trench through the eastern bank and down slope beyond.

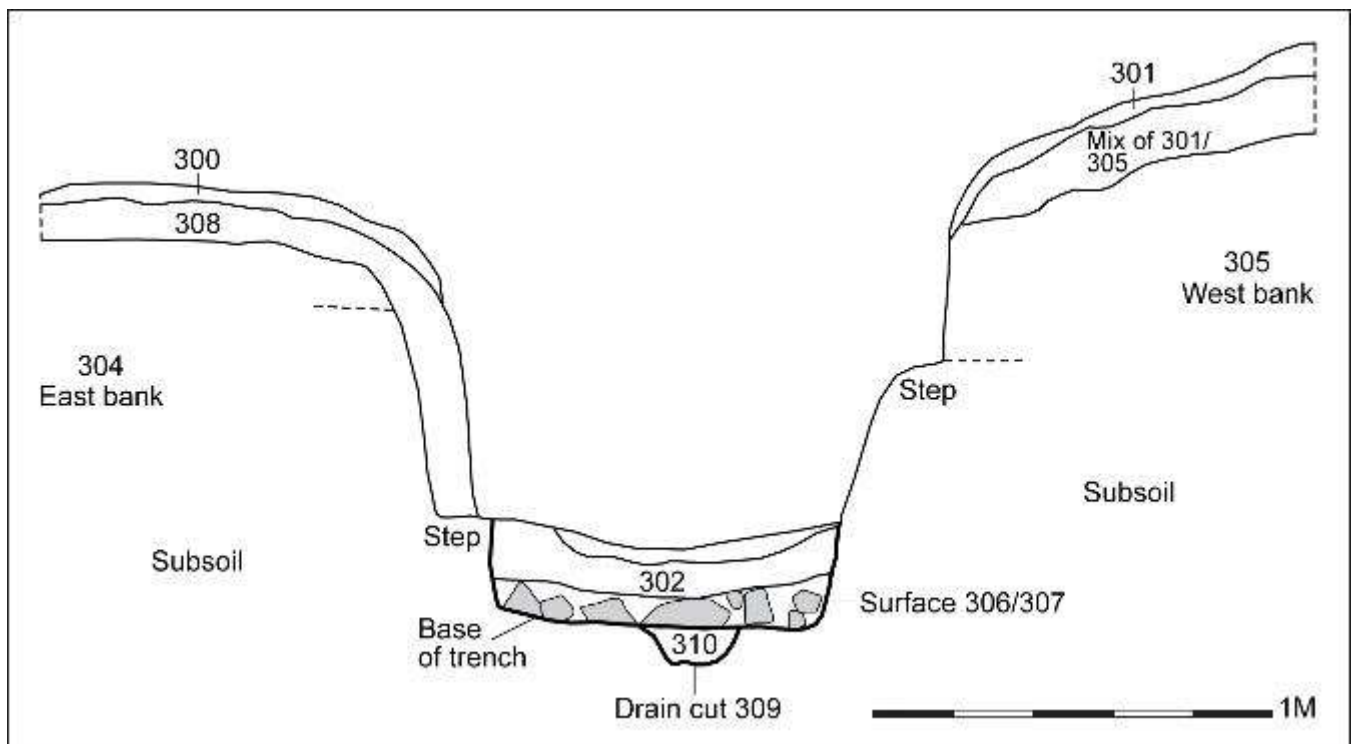

Figure 24. Trench 3. North-facing section through earthen shoreline defensive trench.

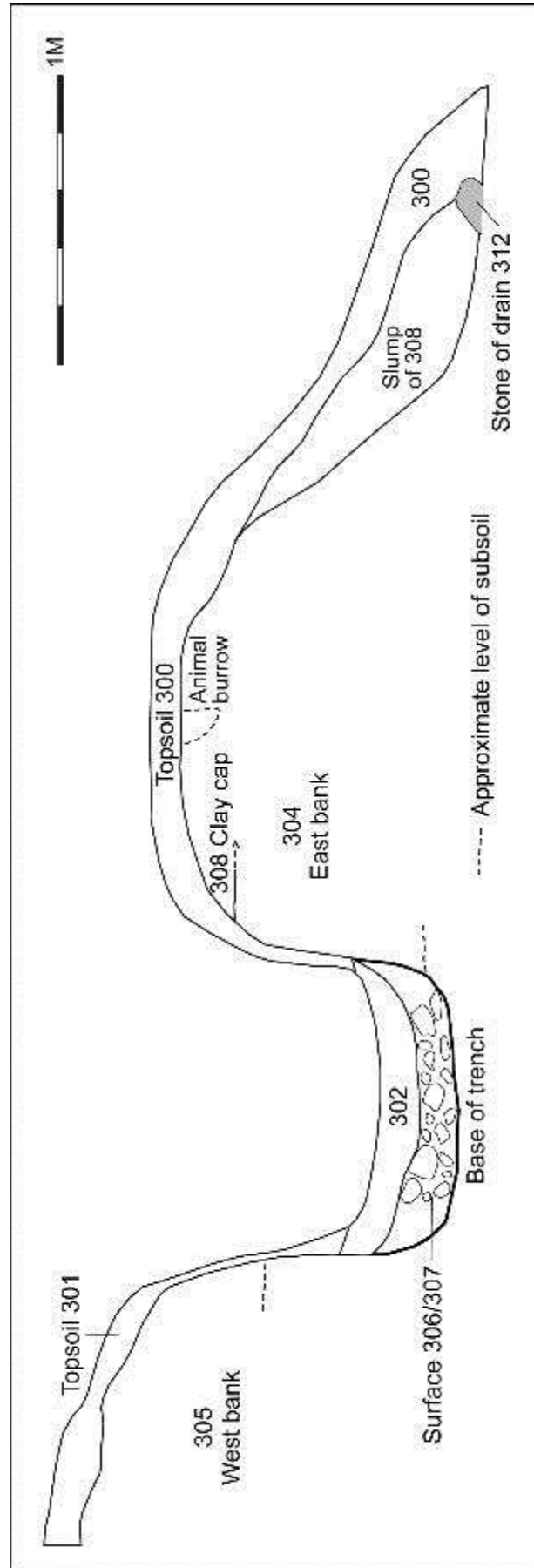

Figure 25. Trench 3. South-facing section through the earthen shoreline defensive trench.

Above the drain in the base of the trench was a layer of small and medium-sized stones and clay (Contexts 306 and 307) that was the deliberately laid floor surface within the trench when it was in use. This horizon was approximately 0.10m deep. A piece of flint, presumably residual, was recovered from the clay matrix of the floor. Over the past 100 years a layer of silt, clay and vegetation (Context 302) had accumulated over the floor of the trench. This was a maximum of 0.15m deep and it constituted topsoil within the trench. From this layer were recovered a glass milk bottle, metal and flint (again, presumably residual). The same material, but not as thickly, covered the western bank of the trench (Context 301) and eastern bank (Context 300).



**Plate 20. Trench 3. Stone surface (C.306/ 307) in the base of the trench and the drain (C.303/ C.312) built into the eastern bank. From North.**



**Plate 21. Trench 3. The subsoil-cut drain (C.309) in the base of the earthen shoreline defensive trench and the larger drain (C.303) built into the eastern bank of the defence. From North.**



**Plate 22. Trench 3. As Plate 21 but from the West.**



**Plate 23. Trench 3, post-excavation, with subsoil-cut drain (C.309) in the base of the earthen shoreline defensive trench and larger drain (C.303). Visible at the extreme right of shot are the stones (C.312) of the drain emerging from the outer face of the bank where water in the base of the trench was diverted downslope and out of the trench.**



#### 3.4.6 Trench 4 (Figure 26; Plates 24-29)

Trench 4 investigated a portion of an earthen machine gun dugout close by and part of the same stretch of coastal shore trench defences as Trench 3. Trench 4 was located 16m south of Trench 3. The dugout was a roughly rectangular-shaped structure that was mostly constructed of earth and wiggly tin. It was accessed from the same earthen shoreline defensive trench that was investigated in Trench 3. A badger set had caused some damage at the internal junction of the northern and eastern walls of the building and a tree is growing on top of the middle of the eastern wall.

During the 2014 excavation vegetation was removed from around the dugout to expose the original clay build and a portion of the northern half of the dugout was investigated. Internally the dugout was approximately 2.8m long, north-south, by 1.60m wide, east-west. Due to time constraints the original floor level of the structure was not uncovered. The earthen walls of the dugout were of varying heights. The eastern wall was exposed to a height of at least 1.1m, while the western wall (bank) that also constituted the eastern bank of the earthen shoreline defensive trench/ practice trench was uncovered to a height of 0.75m. The entrance was located in the north-west wall of the building. A line of four medium-sized stones along the eastern wall, close to the south-east corner of the structure, and others close to the north-west corner suggested that sections of the walls of the dugout were revetted.

Orange-brown keuper marl clay subsoil was located close to the remains of the entrance. In the northern half of the dugout the inner faces of the northern and eastern walls were found to be revetted with sheets of wiggly tin (Context 403) which had slumped on to the base of the dugout due to the degradation of the earthen walls, and in the case of the eastern wall tree root action, behind them. These sheets were left *in situ* within the dugout because of the limited scope of the 2014 excavation. No mettled stone surface, similar to that uncovered in the base of Trench 3, was observed during the excavation as the base of the dugout was not bottomed during the 2014 investigation. Future excavation might clarify this aspect of the dugout.

There were three main horizons encountered within the dugout above the wiggly tin in the northern portion investigated. Directly above the slumped wiggly tin was a thick layer of orange-brown clay loam (Context 404), between 0.40-0.50m thick, which probably represents slump from the dugout walls. This was below a thin and patchy layer of fragmented and corroded wiggly tin (Context 402), possibly representing either a portion of collapsed roof or else later slump of the wiggly tin that revetted the sides of the dugout. The latest horizon was a deposit of humic-rich silt (Context 401) that constituted topsoil and which had accumulated within the dugout after it had gone out of use. It was a maximum of 0.05m thick and contained many roots. Wiggly tin uncovered against the inside face of the southern wall of the dugout when modern vegetation was removed also suggests that the tin revetting was used against all of the four dugout walls.

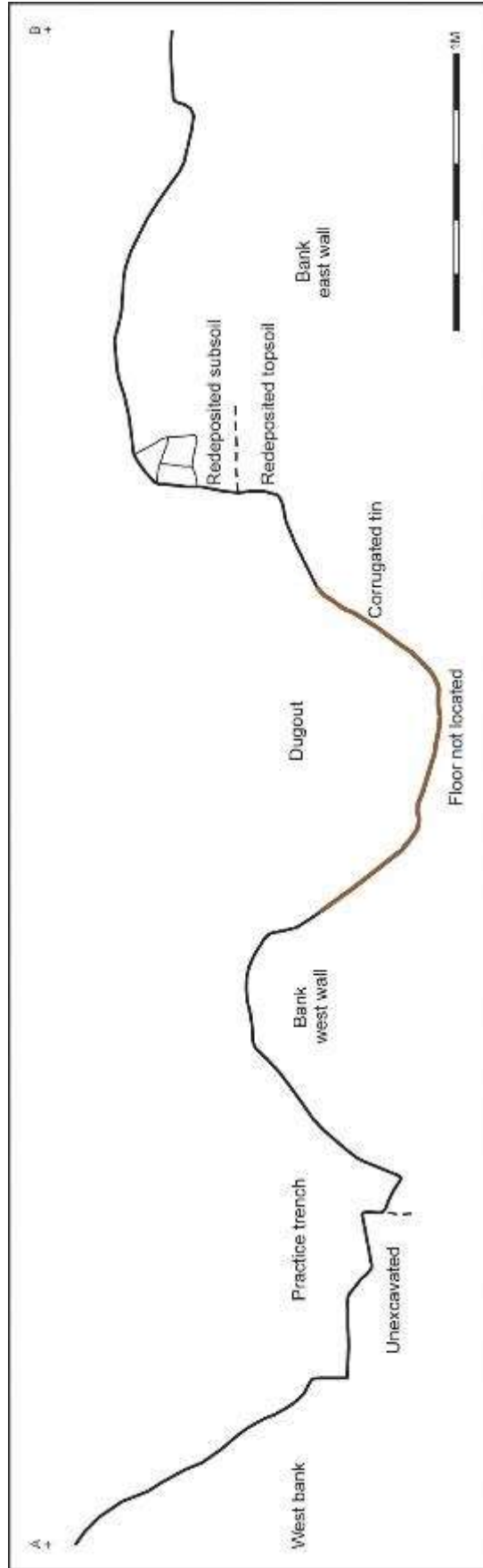

Figure 26. Trench 4. East-west profile across the entrance of the dugout and earthen shoreline defensive trench.

If the level of the natural keuper marl clay uncovered at the entrance to the dugout and in the base of the shoreline defensive trench continued within the interior of the dugout it would mean that the walls would not have extended above chest height for soldiers manning it. It is possible that more detailed future excavation of the interior of the dugout might uncover evidence of a rough roof or shelter above the dugout but during this phase of excavation no obvious roofing material was observed nor were any boards or posts uncovered around the outside of the dugout that such a roof could have been attached to. Although some of the portions of wiggly tin along the inside face of the eastern wall were observed to contain small nail holes it is very possible that the wiggly tin within the dugout was re-used from other structures within Grey Point Fort. Eight spent .22 bullet casings were recovered from Context 404 but little else was found during the limited excavation that shed light on activities that took place within the dugout and how long it was operational.



**Plate 24. Trench 4. The dugout pre-excavation, October 2014. From West.**



**Plate 25. Trench 4. The dugout mid-excavation. Note also the base and western bank of the adjacent earthen shoreline defensive trench. From North.**



**Plate 26. Trench 4. The wiggly tin uncovered in the northern half of the dugout. Note also the stone revetment in the northern, eastern and south-western banks of the dugout. From West.**



**Plate 27. Trench 4. Detail of the wiggly tin in the northern half of the dugout. The tin in the middle of the shot (below the larger ranging rod) probably represents collapsed roofing. That to the left of the shot, along the inner face of the northern is probably revetting of the walls of the structure. From West.**



**Plate 28. Trench 4. As Plate 27, but from South. Note post-abandonment badger set in the north-east corner of the dugout and the tree growing on the eastern wall.**



**Plate 29. Trench 4. The dugout when excavation ceased in November 2014. The exposed wiggly tin is in the foreground covered by the thick layer of slump (C.404) from the dugout banks which has accumulated post-abandonment. From North.**

#### 4. Discussion

Based on the documentary evidence for Grey Point Fort there would appear to have been three broad phases of activity at the Fort, all dating to the 20th century. These phases are:

1. The initial construction of the Fort between 1904-1907 with additional strengthening of the defences round the Fort prior to and during the First World War of 1914-18.
2. A second phase of defensive construction in the 1930s in the years immediately prior to the outbreak of the Second World War in 1939.
3. A final period which commenced when the Fort began to be down-graded in military importance in August 1943, leading to its abandonment as a military fortification after 1956 and its eventual incorporation into Crawfordsburn Country Park in 1971 and its protection as a State Care monument.

The 2014 excavation uncovered evidence of all three main phases of activity at the Fort and helped work out the sequence of some of the defensive construction at the monument.

##### 4.1 Evidence of Pre-Fort activity

Flint, both struck and un-struck, was recovered from most of the excavated trenches. No other early artefacts or features were identified during the excavation. However, given the great location of the Fort overlooking the mouth of Belfast Lough and the Co. Down and Co. Antrim coastlines, as well as the known archaeological sites in the environs of the Fort, it should not be surprising that prehistoric people may have been active in this part of County Down.

##### 4.2 Evidence for Phase One

The section in *Ireland's Defence Scheme. North Irish defended ports Part II, Belfast Defences. Revised to July 1912.* (W.O.33/601, 28) that describes how *A barbed-wire entanglement has been erected around the battery. In the war period trenches and machine-gun emplacements will be constructed, commanding Helen's Bay and the land approaches; and an outer line of wire entanglements will be constructed, enclosing the land defences* is most useful. It suggests that the barbed wire entanglements uncovered in Trenches 1B and Trench 2 pre-date the earthen defences investigated in Trenches 3 and 4 and these all date to Phase One.

It is very possible that that the iron fence pickets uncovered in Trenches 1B and 2 were the remains of the *barbed wire entanglements around the battery completed in January 1911 (Grey Point Fort: Fort Record Book; noted as fence on the plan of Grey Point Battery in 1911, PRO WO 78/4784;)*

Much of the archaeological strata in Trench 1B appear to reflect the deliberate infilling of the bedrock and building up of a level terrace below the Fort guns. Four iron trench pickets (posts), representing the remains of an early barbed wire defensive boundary for the fort were also uncovered in Trench 1B and the practice trench immediately west of it. The pickets were 1.35m apart and would appear to represent a section of a defensive perimeter at the front of the original Fort. Finds from the trench included barbed wire and iron nails. Fragments of struck flint in some of the strata hint at the earlier archaeology that may exist in the environs of the fort.

The earthen trenches and dugouts constructed beyond the boundaries of the Fort proper were well-sited to keep an eye on any potential shore landings by enemy troops. The 2014 excavation showed that some consideration and effort had been put into the construction of these external fortifications. It also showed that these ephemeral defences still survive significantly intact.

The dugout investigated in Trench 4 was probably constructed at the same time as the shoreline/ practice trenches investigated in Trench 3, probably in the first decade of the 20th century, when additional Fort defences were erected in the period of the First World War. It is uncertain how long the dugout was in use. The fortification overlooks a beach and probably housed a machine gun crew that kept watch on this potential landing spot. The .22 shell casings recovered may represent its use for training as higher calibre bullets would have been issued to troops for use in the event of actual hostilities breaking out.

The concrete Blockhouse investigated in Trench 1A possibly also belongs to Phase One. Why no internal features were uncovered within Trench 1A/ the Blockhouse is uncertain. It is possible that the walls of the Blockhouse were actually constructed but that the building was never occupied. It is hard to believe that if the building had been active that all internal features and artefacts relating to its use would have been so clinically removed after it became obsolete.

Large fragments of masonry from the northern wall of the blockhouse were observed in the undergrowth immediately north of the blockhouse and it may be that these were removed to improve the line of sight for soldiers guarding the newly created and later stone perimeter wall of Grey Point Fort dating to Phase Two.

#### **4.3 Evidence for Phase Two**

The stone perimeter wall of the Fort, investigated in Trench 1A and Trench 1B Northern Extension, probably dates to the second main phase of activity at the Fort and it would have replaced the barbed wire entanglements (uncovered in Trenches 1B main trench and Trench 2) that originally surrounded the Fort. This new building work probably took place in the years preceding World War 2 as the defences were strengthened with a more substantial defended perimeter. Although it would appear that the Blockhouse dates to the Phase One defences of Grey Point Fort, the fact that so few internal features were found within the Blockhouse during the 2014 excavation may imply that the stone perimeter wall was built not too long after the Blockhouse and that this earlier concrete defensive structure became obsolete perhaps within less than 20 years after it had been constructed. It may even be that the blockhouse was built as a temporary defensive post while the perimeter wall of the Fort was being erected.

The service cables leading to the most westerly of the coastal searchlight emplacements that was constructed in 1936, and which were uncovered in Trench 2, clearly date to the 1930s and may be contemporary with the building of the stone perimeter wall around the Fort.



Existing oral testimony also recounts that the outlying earthen defensive features in the environs of the Fort were also used extensively during the Second World War (Masefield 2011) but evidence for this was not uncovered in Trenches 3 and 4 during the 2014 excavation.

#### **4.4 Evidence for Phase Three**

Evidence of activity at the Fort after it was decommissioned in 1956 was found in many of the 2014 excavated trenches. These included gravel paths in Trenches 1A, 1B and 2, as well as dumped masonry and concrete, a drain and modern geotextile (terram) all found in Trench 2. Most of this evidence relates to the change in use of Grey Point Fort from a military installation to a visitor attraction within Crawfordsburn Country Park. In recent times a greater appreciation of the quantity and quality of surviving features at the Fort has confirmed the Defence Heritage significance of the fortification leading to its protected status as a State Care monument.

#### **4.5 Evidence of different types of activity at the Fort**

The 2014 archaeological investigations identified a variety of construction techniques used for the defence of the Fort in the first half of the 20th century. Iron was used for the fence pickets of the early barbed wire entanglements, concrete was used to construct the Blockhouse, earth and re-deposited subsoil for the shoreline defences and stone for the later perimeter wall around the Fort. The erection of the defences also involved altering the existing landscape around the Fort and included dumping material to level the terraces below the guns for the insertion of the barbed wire entanglements (Trench 1B), lowering the underlying bedrock (Trenches 1B northern extension and Trench 1A) and the digging into subsoil for construction of the forward shoreline defences (Trenches 3 and 4).

### **5. Conclusions**

The 2014 research excavation at Grey Point Fort, Co. Down, was the first at any such monument in Ireland. Although the investigation did not involve excavation within the core of the complex of buildings of the Fort, much useful and exciting information about the sequence and techniques of construction and activity at the Fort was uncovered from the excavation. The superb survival of the earthen shoreline defensive trenches and dugouts in the area beyond the Fort proper also reinforces the picture that the defences at Grey Point Fort extend beyond the stone buildings within the perimeter walls. As such, any future consideration about the Fort as a monument must also include the more ephemeral defences, most of which still survive in this larger landscape around the Fort proper.

There is great potential for further archaeological work at Grey Point Fort and this will assist in the enhanced presentation of information about this most interesting of fortifications to the public.

## 6. References

- Board of Ordnance & Defence Committees: *The Owens committee – PRO WO, 55/835*.
- Clements, B. (2003). *Defending the North: The Fortifications of Ulster 1796-1956*.
- Gailey, I., & Dixon, H. (1987) *Grey Point Fort, Co. Down*. DOENI guide card.
- Masefield, R. (2011) 'Twixt Bay and Burn'. A History of Helen's Bay and Crawfordsburn. Bayburn Historical Society.
- Montgomery, H. (*in prep*), PhD. *Training Kitchener's New Army, 1914-1916: Archaeological Perspectives on the Irish Experience*.
- Northern Ireland Environment Agency (ndg) *Grey Point Fort: A short guide to the fort complex*.
- Royal Ulster Rifles Museum, Waring Street, Belfast; *Battalion War Diary: Historical Records of the 13<sup>th</sup> Service Battalion Royal Irish Rifles*, Accession No. 2316c.
- Ruffell, A. (2014) *Geophysical Survey for Unexploded Ordnance, Trench 1, Grey Point Fort, Helen's Bay, N. Ireland*. Report prepared for the Centre for Archaeological Fieldwork, Queen's University Belfast and the Northern Ireland Environment Agency. October 2014.
- Schofield, J. (2005) *Combat Archaeology: Material Culture and Modern Conflict*. UK: Gerald Duckworth & Co. Ltd.
- Simkins, P. (2007) *Kitchener's Army: The Raising of the New Armies 1914-1916*. UK: Pen & Sword Military.
- Skinner, R. (2011) *Kitchener's Camp at Seaford: A First World War Landscape on Aerial Photographs*. UK: English Heritage.
- W.O.33/601 *Ireland's Defence Scheme. North Irish defended ports Part II, Belfast Defences. Revised to July 1912*.

<http://www.internationalfortresscouncil.org>

<http://www.militaryarchives.ie>

<http://www.nationalarchives.gov.uk/>

<http://www.proni.gov.uk/>

<http://www.doeni.gov.uk/niea/defence-heritage-record.htm>

## 7. Appendices

Appendix 1. Harris Matrix for site

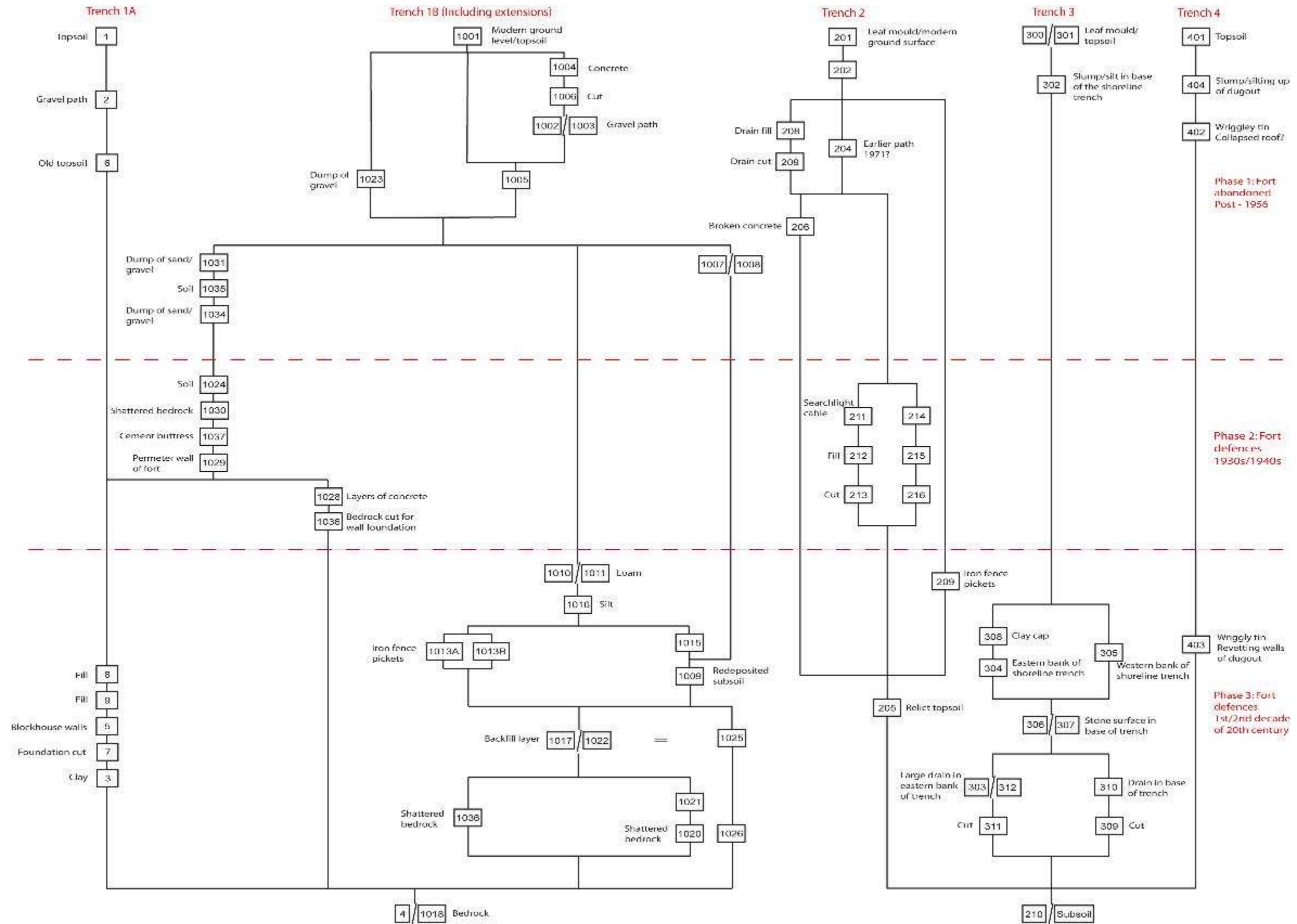

## Appendix 2. Context Register

Trench No.	Context No.	Type	Description
1A	1	Layer	Dark brown humic surface layer
1A	2	Layer	Gravel path around perimeter wall
1A	3	Layer	Orange-brown clay, likely redeposited subsoil
1A	4	Layer	Natural bedrock
1A	5	Wall	Blockhouse wall
1A	6	Layer	Mid brown clay loam topsoil
1A	7	Cut	Foundation cut for blockhouse wall
1A	8	Fill	Grey-brown mortar dust and stones, upper fill of cut c7
1A	9	Fill	Grey cement/concrete, basal fill of cut c7
1B	1001	Layer	Sod layer
1B	1002	Fill	Gravel pathway running NNW-SSE through the trench
1B	1003	Layer	Spread from gravel path, same as c1002
1B	1004	Layer	Concrete block in southern corner of the trench
1B	1005	Layer	Mid-brown loamy topsoil, north-east of c1002
1B	1006	Cut	Cut for gravel pathway c1002
1B	1007	Layer	Brown loamy clay, possibly hill-wash, same as c1008
1B	1008	Layer	Brown loamy clay, possibly hill-wash, same as c1007
1B	1009	Layer	Compact silty clay surface, in south-west of trench
1B	1010	Layer	Mid-brown stony loam below c1005
1B	1011	Fill	Orange-brown sandy loam, upper fill of trench c1015
1B	1012	VOID	VOID
1B	1013	Trench pickets	4 trench pickets within central area of the trench
1B	1014	Layer	Bitumen within c1011
1B	1015	Cut	Possible cut for trench in the south-west of the trench
1B	1016	Layer	Orange-brown clay and sandy silt mottled deposit in north-east end of trench
1B	1017	Layer	Brown sandy silt below c1016
1B	1018	Layer	Shattered/cut bedrock surface
1B	1019	Layer	Dark grey-brown silty loam overlying c1018
1B	1020	Layer	Grey-brown clay loam overlying c1018 in the centre of the trench
1B	1021	Layer	Redeposited orange clay, overlying c1020
1B (SW)	1022	Layer	Brown loam in south-west extension to trench, below c1009
1B (NE)	1023	Layer	Sandy gravel mottled layer in north-east extension to trench
1B (NE)	1024	Layer	Brown loamy clay below c1023
1B (SW)	1025	Layer	Brown loamy silty loam below c1009
1B (SW)	1026	Layer	Orange-mid brown sandy soil below c1025
1B (NE)	1027	Layer	Redeposited orange clay overlying bedrock c1018
1B (NE)	1028	Layer	Concrete batter at base of perimeter wall c1029
1B (NE)	1029	Wall	Upstanding perimeter wall of the fort
1B (NE)	1030	Layer	Dark brown loamy clay overlying c1027
1B (NE)	1031	Layer	Lower layer of mixed up gravelly deposit
1B	1032		
1B	1033		
1B (NE)	1034	Layer	Upper layer of grey gravel
1B (NE)	1035	Layer	Dark brown, compost like loam, possible relict topsoil
1B (NE)	1036	Discontinuity	Episode of clearance/cutting of bedrock
1B (NE)	1037	Layer	Concrete "plinth" below c1029, above c1028
2	201	Layer	Dark brown humic layer of leaf mould
2	202	Layer	Gravel path around perimeter wall
2	203	Layer	Plastic sheeting (Terram)
2	204	Layer	Second gravel path around perimeter wall
2	205	Layer	Mid-brown sandy, silty loam, likely a relict topsoil

2	206	Layer	Broken concrete slabs
2	207	Cut	Shallow gully, likely a drain
2	208	Fill	Mid-grey gravel fill for cut c207
2	209	Trench pickets	Remains of four metal trench pickets, likely for supporting barbed wire entanglements
2	210	Layer	Orange/yellow sandy clay, natural subsoil
2	211	Cables	5 cables, likely for supplying power to the searchlight situated to the north-west
2	212	Fill	Mid-brown sandy loam, fill of cut c213
2	213	Cut	Cut for service cables c211
2	214	Fill	Orange-brown clay loam, upper fill of cut c216
2	215	Fill	Mid-brown silty loam, basal fill of cut c216
2	216	Cut	Cut into relict topsoil c205
3	300	Layer	Mid-grey/brown loam, topsoil over eastern bank
3	301	Layer	Mid-grey/brown loam, topsoil over western bank
3	302	Layer	Dark brown humic layer, topsoil over base of trench
3	303	Layer	Drain feature in east bank
3	304	Layer	Upper deposit of the east bank
3	305	Layer	Upper deposit of the west bank
3	306	Layer	Stone layer in base of practise trench
3	307	Layer	Soil matrix around stones c306
3	308	Layer	Subsoil "cap" on top of the eastern bank
3	309	Cut	Cut for drain feature in the base of the practise trench
3	310	Fill	Fill of cut for drain feature in the base of the practise trench
3	311	Layer	Orange clay, natural subsoil
4	401	Layer	Dark brown humic surface layer
4	402	Layer	Iron layer within interior of dug out
4	403	Layer	Sheets of corrugated "wiggly" tin, likely to be the collapsed roof of the dug out
4	404	Layer	Orange-brown redeposited subsoil, slump from the sides of the dug out
4	405	Layer	Orange clay, natural subsoil

**Appendix 3. Field Drawing Register.**

<b>DRAWING NO.</b>	<b>TRENCH NO.</b>	<b>TYPE</b>	<b>SCALE</b>	<b>DESCRIPTION</b>
1	1B	Plan	1:20	Mid-excavation plan of surface of c1002, following removal of c1001
2	1B	Plan	1:20	Mid-excavation plan following removal of c1002 and c1005
3	1A	Section	1:10	South facing section of Trench 1A
4	2 (South)	Plan	1:20	Mid-excavation plan with surface of feature c206
5	2 (South)	Plan	1:20	Post-excavation plan following removal of c208
6	2 (South)	Plan	1:20	Post-excavation plan following removal of c207
7	2 (South)	Plan	1:20	Post-excavation plan following removal of c205 and c206
8	2 (South)	Section	1:10	North facing section of Trench 2 (South)
9	2 (South)	Section	1:10	West facing section of Trench 2 (South)
10	2 (South)	Section	1:10	East facing section of Trench 2 (South)
11	1A	Plan	1:20	Plan of trench and blockhouse
12	1A	Plan	1:20	Plan showing the foundation cut for the blockhouse wall, cut c107, and fill c108
13	1A	Section	1:10	East facing section through northern half of trench (short end of "L" shaped extension)
14	1A	Section	1:10	East facing section through northern half of trench (long end of "L" shaped extension)
15	1A	Section and elevation	1:20	West facing section through trench and elevation of blockhouse wall
16	1B	Plan	1:20	Mid-excavation plan, following the removal of c1011
17	1B	Plan	1:20	Post-excavation plan of the north-east end of the trench, showing the bedrock c1018
18	1B	Section	1:10	South-west facing section of north-east end of Trench 1B
19	1B	Section	1:10	North-east facing section of north-east end of Trench 1B
20	1B	Section	1:10	
21	1A	Section and elevation	1:20	East facing section through trench and west facing elevation of blockhouse wall
22	1A	Elevation	1:20	East facing elevation of blockhouse wall
23				
24	1B	Section	1:10	North-West facing section of Trench 1B
25	2 (North)	Plan	1:20	Mid-excavation plan following removal of c203
26	2 (North)	Plan	1:20	Mid-excavation plan following removal of c208
27	2 (North)	Plan	1:20	Mid-excavation plan following removal of c204
28	1A	Section and elevation	1:20	West facing section through trench and east facing elevation of blockhouse wall
29	1A	Elevation	1:20	West facing elevation of blockhouse wall (Interior)
30	1B	Plan	1:20	Mid-excavation plan of surface of c1009 (South extension of trench)
31	1A	Elevation	1:10	Elevation of perimeter wall apex (Exterior)
32	1B (NE ext)	Elevation	1:10	Elevation of perimeter wall apex (Interior)
33	1B (NE ext)	Plan	1:20	Post-excavation plan of Trench 1B (North-east extension)

34	2	Plan	1:20	Post-excavation plan of Trench 2
35	VOID	VOID	VOID	VOID
36	1B (NE ext)	Section	1:10	North-east facing section of Trench 1B (North-east extension)
37	1B (NE ext)	Section	1:10	South-east facing section of Trench 1B (North-east extension)
38	1B (NE ext)	Section	1:10	North-west facing section of Trench 1B (North-east extension)
39	3	Plan	1:20	Mid-excavation plan of Trench 3, prior to extension
40	3	Section	1:20	South facing section of Trench 3
41	3	Elevation	1:20	West-facing side of east bank and drain (c303) elevation
42	4	Plan	1:20	Mid-excavation plan of Trench 4, following removal of c401
43	4	Plan	1:20	Mid-excavation plan of Trench 4, following removal of c404
44	4	Profile	1:10	North/south profile across middle of dug out
45	4	Profile	1:10	North/south profile across entrance of dug out
46	4	Profile	1:10	East/west profile across entrance of dug out
47	4	Profile	1:10	East/west profile across middle of dug out
48	1B (SW ext)	Section	1:10	North-west facing section of Trench 1B (South-west extension)
49	1B (SW ext)	Section	1:10	South-east facing section of Trench 1B (South-west extension)
50	1B (SW ext)	Section	1:10	North-east facing section of Trench 1B (South-west extension)
51	1B (SW ext)	Section	1:10	South-west facing section of Trench 1B (South-west extension)
52	3	Plan	1:20	Post-excavation plan of the base of the practise trench through Trench 3, following excavation of stones (c306) and drain (c303)
53	3	Plan	1:20	Post-excavation plan of Trench 3 following extension of trench
54	3	Section	1:20	North facing section through the practise trench



#### Appendix 4. Photographic Register

Photo	Trench	Description	Looking
2948	1A	Working shot following removal of surface vegetation	NW
2949	1A	Working shot following removal of surface vegetation	N
2950	1A	Working shot following removal of surface vegetation	SW
2951	1A	Working shot following removal of surface vegetation	S
2952	2	Mid-excavation shot during removal of quarry dust	N
2953	2	Mid-excavation shot during removal of quarry dust	NW
2954	2	Mid-excavation shot during removal of quarry dust	N
2955	2	Mid-excavation shot during removal of quarry dust	S
2556	1B	Trench following removal of sod layer	N
2957	1B	Trench following removal of sod layer	N
2958	1B	View of trench pickets	W
2959	1B	Trench following removal of sod layer	S
2960	1B	Working shot during removal of path c1002	E
2961	1B	Working shot during removal of path c1002	W
2962	1A	Working shot during removal of c2 and c3	SW
2963	1A	Working shot during removal of c2 and c3	SW
2964	2	Mid-excavation working shot following the removal of c201 and c202	S
2965	2	Mid-excavation working shot following the removal of c201 and c202	S
2966	2	Mid-excavation working shot following the removal of c201 and c202	N
2967	1A	Post-excavation shot of the northern half of the initial trench	N
2968	1A	Post-excavation shot of the northern half of the initial trench	NE
2969	1A	Post-excavation shot of the northern half of the initial trench	W
2970	1A	Post-excavation shot of the northern half of the initial trench	S
2971	1A	Post-excavation shot of the northern half of the initial trench	S
2972	1B	Pre-excavation shot of c1007 and c1008	NW
2973	1B	Pre-excavation shot of possible feature within c1008	NE
2974	1B	Working shot of the trench at the end of the day	N
2975	1B	Working shot of north-eastern end of the trench at the end of the day	N
2976	1B	Post-excavation shot following excavation of a section through c1007 and c1008	NE
2977	1B	Post-excavation shot following excavation of a section through c1007 and c1008	NE
2978	1B	Post-excavation shot following excavation of a section through c1007 and c1008	SW
2979	1A	Post-excavation shot of the northern half of the trench, showing bedrock c4 and blockhouse wall c5	E
2980	1A	Post-excavation shot of the northern half of the trench, showing bedrock c4 and blockhouse wall c5	E
2981	1A	Post-excavation shot of the northern half of the trench, showing bedrock c4 and blockhouse wall c5	E
2982	1A	Post-excavation shot of the northern half of the trench, showing bedrock c4 and blockhouse wall c5	SE
2983	1A	Post-excavation shot of the northern half of the trench, showing bedrock c4 and blockhouse wall c5	SE
2984	2	Mid-excavation shot of c205, c206 and c207 following removal of modern path	S
2985	2	Mid-excavation shot of c205, c206 and c207 following removal of modern path	S
2986	2	Mid-excavation shot of c205, c206 and c207 following removal of modern path	SW
2987	2	Mid-excavation shot of c205, c206 and c207 following removal of	SW

		modern path	
2988	2	Mid-excavation detail shot of rubble c206	In plan
2989	2	Mid-excavation detail shot of rubble c206	In plan
2990	1B	Shot showing reinstating of the path in the southern end of the trench	W
2991	1B	Working shot of excavations in the trench	E
2992	1B	Working shot of excavations in the trench	E
2993	1B	Working shot of excavations in the trench	S
2994	2	Mid-excavation shot following removal of c208	S
2995	2	Mid-excavation shot following removal of c208	S
2996	2	Mid-excavation shot following removal of c208	SE
2997	2	Mid-excavation shot following removal of c208	E
2998	2	Mid-excavation shot following removal of c208, showing c207	S
2999	2	Mid-excavation shot following removal of c208, showing c206	E
3000	2	Mid-excavation shot following removal of c208, showing c206	S
3001	2	Mid-excavation shot of c205 and c206	S
3002	2	Mid-excavation shot of c205 and c206	S
3003	2	Mid-excavation shot of c205 and c206	N
3004	2	Mid-excavation shot of c205 and c206	N
3005	2	Mid-excavation shot of c205 and c206	E
3006	1B	Mid-excavation shot following desodding of trenches for primary school children and removal of c1010 from the central trench	NE
3007	1B	Mid-excavation shot following desodding of trenches for primary school children and removal of c1010 from the central trench	NE
3008	1B	Mid-excavation shot following removal of c1010 from the central trench	NE
3009	1B	Mid-excavation shot following removal of c1010 from the central trench	SW
3010	1B	Pre-excavation shot of possible posthole c1012	E
3011	1B	Mid-excavation shot showing trench pickets	NW
3012	1B		NE
3013	1B	Mid-excavation shot of c1014, bitumen within c1011	SE
3014	1B	Mid-excavation shot of c1014, bitumen within c1011	SE
3015	1B	Mid-excavation shot of north-eastern end of trench, following removal of c1010	NW
3016	1B	Pre-excavation shot of possible south-western edge for trench c1015	NW
3017	1B	Pre-excavation shot of possible south-western edge for trench c1015	NW
3018	1B	Working shot of excavations within this trench	E
3019	1B	Working shot of excavations within this trench	E
3020	1B	Working shot of excavations within this trench	W
3021	1B	Working shot of excavations within this trench	W
3022	1B	Working shot of excavations within this trench	W
3023	1A/1B	Working shot of excavations within these trenches	N
3024	1A/1B	Working shot of excavations within these trenches	N
3025	2	Concrete fragment found within trench	In plan
3026	2	Concrete fragment found within trench	In plan
3027	2	Working shot of excavations within this trench, showing trench pickets	E
3028	2	Working shot of excavations within this trench, showing trench pickets	E
3029	2	Working shot of excavations within this trench, showing trench pickets	E
3030	2	Working shot of excavations within this trench, showing trench pickets	E
3031	1A	Post-excavation shot of the initial trench, showing the surface of the bedrock c4 and the blockhouse wall c5	S

3032	1A	Post-excavation shot of the initial trench, showing the surface of the bedrock c4 and the blockhouse wall c5	S
3033	1A	Post-excavation shot of the initial trench, showing the surface of the bedrock c4 and the blockhouse wall c5	SW
3034	1A	Post-excavation shot of the initial trench, showing the surface of the bedrock c4 and the blockhouse wall c5	SW
3035	1A	Post-excavation shot to show detail of under the perimeter wall of the fort and the back wall of the blockhouse, c5	S
3036	1A	Post-excavation shot to show detail of under the perimeter wall of the fort and the back wall of the blockhouse, c5	S
3037	1A	Post-excavation shot to show detail of under the perimeter wall of the fort and the back wall of the blockhouse, c5	S
3038	1A	Post-excavation shot to show detail of under the perimeter wall of the fort and the back wall of the blockhouse, c5	S
3039	1A	Post-excavation shot of the initial trench, showing the surface of the bedrock c4 and the blockhouse wall c5	S
3040	1A	Post-excavation shot of the initial trench, showing the surface of the bedrock c4 and the blockhouse wall c5	S
3041	1A	Post-excavation shot of the initial trench, showing the surface of the bedrock c4 and the blockhouse wall c5, and working shot of Trench 1B	S
3042	1A	Post-excavation shot of the initial trench, showing the surface of the bedrock c4 and the blockhouse wall c5, and working shot of Trench 1B	S
3057	1A	Post-excavation shot of the initial trench, showing the surface of the bedrock c4 and the blockhouse wall c5	S
3058	1A	Post-excavation shot of the initial trench, showing the surface of the bedrock c4 and the blockhouse wall c5	S
3059	1A	Post-excavation shot of the initial trench, showing the surface of the bedrock c4 and the blockhouse wall c5	S
3060	1A	Post-excavation shot of the initial trench, showing the surface of the bedrock c4 and the blockhouse wall c5	S
3061	1A	Post-excavation shot of the initial trench, showing the surface of the bedrock c4 and the blockhouse wall c5	SW
3062	1A	Post-excavation shot of the initial trench, showing the surface of the bedrock c4 and the blockhouse wall c5	SW
3063	1A	Post-excavation shot of north facing section of trench	S
3064	1A	Post-excavation shot of north facing section of trench	S
3065	1A	Post-excavation shot of the line of the wall in the eastern side of the trench	S
3066	1A	Post-excavation shot of the line of the wall in the eastern side of the trench	S
3067	1A	Post-excavation shot of the line of the wall in the western side of the trench	S
3068	1A	Post-excavation shot of the line of the wall in the western side of the trench	S
3069	1A	Post-excavation shot of the east facing section of the trench	W
3070	1A	Post-excavation shot of the east facing section of the trench	W
3071	1A	Post-excavation shot of the east facing section of the trench	W
3072	1A	Post-excavation shot of the west facing section of the trench	E
3073	1A	Post-excavation shot of the west facing section of the trench	E
3074	1A	Post-excavation shot of the west facing section of the trench	E
3075	1A	Post-excavation shot of the west facing section of the trench	E
3076	1A	Post-excavation shot of the west facing section of the trench	E
3077	1A	Post-excavation shot of the initial trench, showing the surface of the bedrock c4 and the blockhouse wall c5	NE
3078	1A	Post-excavation shot of the initial trench, showing the surface of the bedrock c4 and the blockhouse wall c5	NE
3079	1A	Post-excavation shot of the initial trench, showing the surface of	NE

		the bedrock c4 and the blockhouse wall c5	
3080	1A	Post-excavation shot of the initial trench, showing the surface of the bedrock c4 and the blockhouse wall c5	NE
3081	1A	Post-excavation shot of the south facing section of the trench	N
3082	1A	Post-excavation shot of the south facing section of the trench	N
3083	1B	Mid-excavation shot of trench following removal of c1011	NE
3084	1B	Mid-excavation shot of trench following removal of c1011	NE
3085	1B	Mid-excavation shot of trench following removal of c1011	SW
3086	1B	Mid-excavation shot of trench showing trench pickets c1013a and c1013b and the surface of c1016	SE
3087	1B	Mid-excavation shot of trench showing trench pickets c1013a and c1013b and the surface of c1016	SE
3088	1B	Mid-excavation shot of trench showing trench pickets c1013a and c1013b, cut c1015 and the surface of c1016	N
3089	1B	Mid-excavation shot of trench showing trench pickets c1013a and c1013b, and surfaces c1016 and c1017	NW
3090	1B	Mid-excavation shot of trench following removal of c1011	NE
3091	1B	Mid-excavation shot of trench following removal of c1011	SW
3092	1A	Mid-excavation shot of trench prior to extension to the north	N
3093	1A	Mid-excavation shot of trench prior to extension to the north	N
3094	1A	Post-excavation view of the back wall of the blockhouse c5 and perimeter wall of the fort	S
3095	1A	Post-excavation view of the back wall of the blockhouse c5 and perimeter wall of the fort	S
3096	1A	Post-excavation view of the back wall of the blockhouse c5 and perimeter wall of the fort	S
3097	1A	Post-excavation view of the back wall of the blockhouse c5 and perimeter wall of the fort	S
3098	1B	Mid-excavation shot showing the surface of c1017	NE
3099	1B	Mid-excavation shot showing the surface of c1017	SE
3100	1B	Mid-excavation shot showing the surface of c1017	NE
3101	1B	Mid-excavation shot of the north eastern end of the trench showing the surface of c1017	NE
3102	1B	Mid-excavation shot of surface of c1017, with cleaned up brick present	NW
3103	1B	Mid-excavation shot of trench pickets (c1013a and c1013b) to show their angles	SE
3104	2	Post-excavation shot of the southern half of the trench, showing the surface of the subsoil c210	S
3105	2	Post-excavation shot of the southern half of the trench, showing the surface of the subsoil c210	SE
3106	2	Post-excavation shot of the southern half of the trench, showing the surface of the subsoil c210	E
3107	2	Post-excavation shot of the southern half of the trench, showing the surface of the subsoil c210	W
3108	2	Post-excavation shot of the southern half of the trench, showing the surface of the subsoil c210	W
3109	2	Post-excavation shot of the southern half of the trench, showing the surface of the subsoil c210	NE
3110	2	Post-excavation shot of the southern half of the trench, showing the surface of the subsoil c210	NE
3111	2	Post-excavation shot of the west facing section of the southern half of the trench	E
3112	2	Post-excavation shot of the west facing section of the southern half of the trench	E
3113	2	Post-excavation shot of the north facing section of the southern half of the trench	S
3114	2	Post-excavation shot of the north facing section of the southern half of the trench	S

3115	2	Post-excavation shot of the north facing section of the southern half of the trench	S
3116	2	Post-excavation shot of the east facing section of the southern half of the trench	W
3117	2	Post-excavation shot of the east facing section of the southern half of the trench	W
3118	2	Post-excavation shot of the west facing section of the southern half of the trench	E
3119	2	Post-excavation shot of the west facing section of the southern half of the trench	E
3120	2	Post-excavation show of trench picket c209 in the south of the southern half of the trench	S
3121	2	Post-excavation show of trench picket c209 in the mid-west of the southern half of the trench	S
3122	2	Post-excavation show of trench picket c209 in the mid-east of the southern half of the trench	S
3123	2	Post-excavation show of trench picket c209 in the north-west of the southern half of the trench	W
3124	1B	Mid-excavation shot showing trench pickets c1013a and c1013b, surface c1017 and bedrock c1018	SW
3125	1B	Mid-excavation shot showing trench pickets c1013a and c1013b, surface c1017 and bedrock c1018	W
3126	1B	Mid-excavation shot showing trench pickets c1013a and c1013b, surface c1017 and bedrock c1018	NE
3127	1B	Working shot of one of the trenches opened to facilitate primary school children involvement	E
3128	1B	Working shot of one of the trenches opened to facilitate primary school children involvement	N
3129	1A	Pre-excavation shot of foundation trench c7 in north-eastern extension	N
3130	1A	Pre-excavation shot of foundation trench c7 in north-eastern extension	N
3131	1A	Pre-excavation shot of foundation trench c7 in north-eastern extension	E
3132	1A	Pre-excavation shot of foundation trench c7 in north-eastern extension	E
3133	1B	Working shot of excavations within this trench	S
3134	1A	Pre-excavation shot of foundation trench c7 in north-eastern extension	E
3135	1A	Pre-excavation shot of foundation trench c7 in north-eastern extension	E
3136	1A	Pre-excavation shot of foundation trench c7 in north-eastern extension	E
3137	1A	Pre-excavation shot of foundation trench c7 in north-eastern extension	E
3138	1A	Pre-excavation shot of foundation trench c7 in north-eastern extension	S
3139	1A	Pre-excavation shot of foundation trench c7 in north-eastern extension	S
3140	N/A	Working shot	N/A
3141	1A	Rubble behind the blockhouse following vegetation clearance	W
3142	1A	Rubble behind the blockhouse following vegetation clearance	W
3143	1A	Rubble behind the blockhouse following vegetation clearance	NW
3144	1A	Rubble behind the blockhouse following vegetation clearance	W
3145	1A	Rubble behind the blockhouse following vegetation clearance	E
3146	1A	Rubble behind the blockhouse following vegetation clearance	E
3147	1A	Mid-excavation shot of foundation trench c7 following the removal of fill c8 in north-eastern extension	N
3148	1A	Mid-excavation shot of foundation trench c7 following the removal	N

		of fill c8 in north-eastern extension	
3149	1A	Mid-excavation shot of foundation trench c7 following the removal of fill c8 in north-eastern extension	E
3150	1A	Mid-excavation shot of foundation trench c7 following the removal of fill c8 in north-eastern extension	S
3151	1A	Mid-excavation shot of foundation trench c7 following the removal of fill c8 in north-eastern extension	S
3152	1A	Mid-excavation shot of foundation trench c7 following the removal of fill c8 in north-eastern extension	SE
3153	1A	Mid-excavation shot of foundation trench c7 following the removal of fill c8 in north-eastern extension	SE
3154	2	Post-excavation shot of the south facing section between the north and south halves of this trench prior to removal	NE
3155	2	Post-excavation shot of the south facing section between the north and south halves of this trench prior to removal	NE
3156	2	Post-excavation shot of the south facing section between the north and south halves of this trench prior to removal	NE
3157	1B	Working shot of excavations within this trench	NE
3158	1B	Working shot of excavations within this trench	NE
3159	1B	Working shot of excavations within this trench	NE
3160	1B	Working shot of excavations within this trench	NE
3161	1B	Working shot of excavations within this trench	NE
3162	1A	Working shot of the mechanical digger removing the topsoil across the remainder of the blockhouse interior	W
3163	1A	Working shot of the mechanical digger removing the topsoil across the remainder of the blockhouse interior	N
3164	1A	Working shot of the mechanical digger removing the topsoil across the remainder of the blockhouse interior	N
3165	2	Mid-excavation shot showing the surface of c203 in the northern half of the trench	SE
3166	2	Mid-excavation shot showing the surface of c203 in the northern half of the trench	S
3167	2	Mid-excavation shot showing the surface of c203 in the northern half of the trench	NE
3168	1B	Working shot of excavations within this trench	S
3169	1B	Working shot of excavations within this trench	S
3170	1B	Working shot of excavations within this trench	N
3171	1B	Working shot of excavations within this trench	N
3172	2	Mid-excavation shot following the removal of c203, showing the surfaces of c204, c205, c206, c208 and cut c207 in the northern half of this trench	SE
3173	2	Mid-excavation shot following the removal of c203, showing the surfaces of c204, c205, c206, c208 and cut c207 in the northern half of this trench	S
3174	2	Mid-excavation shot following the removal of c203, showing the surfaces of c204, c205, c206, c208 and cut c207 in the northern half of this trench	NE
3175	2	Mid-excavation shot following the removal of c203, showing the surfaces of c204, c205, c206, c208 and cut c207 in the northern half of this trench	N
3176	2	In situ metalwork on the surface of c204	W
3177	2	In situ metalwork on the surface of c204	W
3178	2	Mid-excavation shot of drain cut c207	S
3179	2	Mid-excavation shot of drain cut c207	S
3180	2	Mid-excavation shot of drain cut c207	W
3181	1B	Mid-excavation shot of the surface of bedrock c1018 in the north-eastern end of the trench	NE
3182	1B	Mid-excavation shot of the surface of bedrock c1018 in the north-eastern end of the trench	NE

3183	1B	Mid-excavation shot of the surface of bedrock c1018 in the north-eastern end of the trench	SW
3184	1B	Mid-excavation shot of the surface of bedrock c1018 in the north-eastern end of the trench	SW
3185	1B	Post-excavation shot of the south-east facing section of the north-eastern end of the trench	NW
3186	1B	Post-excavation shot of the south-east facing section of the north-eastern end of the trench	NW
3187	1B	Post-excavation shot of the south-east facing section of the north-eastern end of the trench	NW
3188	1B	Post-excavation shot of the south-east facing section of the north-eastern end of the trench	NW
3189	1B	Post-excavation shot of the south-east facing section of the north-eastern end of the trench	NW
3190	1B	Post-excavation shot of the south-east facing section of the north-eastern end of the trench	NW
3191	1B	Post-excavation shot of the north-west facing section of the north-eastern end of the trench	SE
3192	1B	Post-excavation shot of the north-west facing section of the north-eastern end of the trench	SE
3193	1B	Post-excavation shot of the north-west facing section of the north-eastern end of the trench	SE
3194	1B	Post-excavation shot of the north-west facing section of the north-eastern end of the trench	SE
3195	1B	Post-excavation shot of the north-west facing section of the north-eastern end of the trench	SE
3196	1B	Post-excavation shot of the north-west facing section of the north-eastern end of the trench	SE
3197	1B	Post-excavation shot of the south-west facing section of the north-eastern end of the trench	NE
3198	1B	Post-excavation shot of the south-west facing section of the north-eastern end of the trench	NE
3199	1B	Post-excavation shot of the south-west facing section of the north-eastern end of the trench	NE
3200	1B	Post-excavation shot of the south-east facing section of the north-eastern end of the trench	NW
3201	1B	Post-excavation shot of the south-east facing section of the north-eastern end of the trench	NW
3202	1B	Post-excavation shot of the north-east facing section of the north-eastern end of the trench	SW
3203	1B	Post-excavation shot of the north-east facing section of the north-eastern end of the trench	SW
3204	1B	Post-excavation shot of the north-west facing section of the north-eastern end of the trench	SE
3205	1B	Post-excavation shot of the north-west facing section of the north-eastern end of the trench	SE
3206	1B	Concrete with c1017 in the north-west facing section of the north-eastern end of the trench	SE
3207	1B	Concrete with c1017 in the north-west facing section of the north-eastern end of the trench	SE
3208	1B	Concrete with c1017 in the north-west facing section of the north-eastern end of the trench	In plan
3209	1B	Concrete with c1017 in the north-west facing section of the north-eastern end of the trench	In plan
3210	1A	Working shot of excavations within this trench	NE
3211	1B	Concrete with c1017 in the north-west facing section of the north-eastern end of the trench	SW
3212	1B	Concrete with c1017 in the north-west facing section of the north-eastern end of the trench	SW

3213	1B	Corroded iron adhering to the surface of the bedrock c1018	NW
3214	1B	Corroded iron adhering to the surface of the bedrock c1018	NW
3215	1B	Post-excavation shot of the whole trench following the clean-up of bedrock c1018 in the north-eastern end of the trench	NE
3216	1B	Post-excavation shot of the whole trench following the clean-up of bedrock c1018 in the north-eastern end of the trench	NE
3217	1B	Post-excavation shot of the whole trench following the clean-up of bedrock c1018 in the north-eastern end of the trench	NE
3218	1B	Post-excavation shot of the whole trench following the clean-up of bedrock c1018 in the north-eastern end of the trench	N
3219	1B	Mid-excavation of the south-western end of the trench, following the removal of the reinstated gravel path	SE
3220	1B	Mid-excavation of the south-western end of the trench, following the removal of the reinstated gravel path	NE
3221	1B	Mid-excavation of the south-western end of the trench, following the removal of the reinstated gravel path	NW
3222	1A	Working shot of excavations within this trench	NW
3223	1A	Working shot of excavations within this trench	NW
3224	1A	Working shot of excavations within this trench	W
3225	1B	Working shot of excavations within this trench	SW
3226	1A	Working shot of excavations within this trench	W
3227	2	Mid-excavation shot showing the surface of c205 in the northern half of this trench	SE
3228	2	Mid-excavation shot showing the surface of c205 in the northern half of this trench	NE
3229	2	Mid-excavation shot showing the surface of c205 in the northern half of this trench	S
3230	2	Mid-excavation shot showing c206 on the surface of c205 in the northern half of this trench	S
3231	2	Mid-excavation shot showing c206 on the surface of c205 in the northern half of this trench	S
3234	1A	Post-excavation shot of the blockhouse	NW
3235	1A	Post-excavation shot of the blockhouse	NW
3236	1A	Post-excavation shot of the blockhouse, showing detail of the southern half of the trench	NW
3237	1A	Post-excavation shot of the blockhouse	NW
3238	1A	Post-excavation shot of the blockhouse	N
3239	1A	Post-excavation shot of the blockhouse	NE
3240	1A	Post-excavation shot of the blockhouse	NE
3241	1A	Post-excavation shot of the blockhouse, showing detail of the southern half of the trench	NE
3242	1A	Post-excavation shot of the blockhouse	NE
3243	1A	Post-excavation shot of the blockhouse, showing detail of the north and west walls	NW
3244	1A	Post-excavation shot of the blockhouse, showing detail of the north and west walls	NW
3245	1A	Post-excavation shot of the blockhouse	SE
3246	1A	Post-excavation shot of the blockhouse, showing detail of the west wall	W
3247	1A	Post-excavation shot of the blockhouse	SW
3248	1A	Post-excavation shot of the blockhouse, showing detail of the northern half of the trench	S
3249	1A	Post-excavation shot of the blockhouse, showing detail of the north-west corner of the trench	S
3250	1A	Post-excavation shot of the blockhouse, showing detail of the northern part of the trench beside the apex	NW
3251	1A	Post-excavation shot of the blockhouse	SW
3252	1A	Post-excavation shot of the blockhouse, showing detail of the eastern half of trench	SW



3253	1A	Post-excavation shot of the blockhouse, showing detail of the western half of trench	SW
3254	1A	Post-excavation shot of the blockhouse, showing detail of the north-west corner of the trench	SW
3255	1A	Post-excavation shot of the blockhouse, showing detail of the north-west corner of the trench	SW
3256	1A	Post-excavation shot of the blockhouse, showing detail of the north-west corner of the trench	W
3257	1A	Post-excavation shot of the blockhouse, showing detail of the north-east corner of the trench	E
3258	1A	Post-excavation shot of the blockhouse, showing detail of the north-east corner of the trench	E
3259	1A	Post-excavation shot of the blockhouse, showing detail on the apex of the wall	NE
3260	1A	Post-excavation shot of the blockhouse, showing detail on the southern half of the trench	E
3261	1A	Post-excavation shot of the blockhouse, showing detail on the southern half of the trench	NE
3262	1A	Post-excavation shot of the blockhouse, showing detail on the northern half of the trench	N
3263	1A	Post-excavation shot of the blockhouse, showing detail on the southern half of the trench	N
3264	1A	Post-excavation shot of the blockhouse, showing detail on the northern half of the trench	N
3265	1A	Post-excavation shot of the blockhouse, showing detail on the northern half of the trench	N
3266	1A	Post-excavation shot of the blockhouse	NE
3267	1A	Post-excavation shot of the blockhouse	NE
3268	1A	Post-excavation shot of the blockhouse	NE
3269	1A	Post-excavation shot of the blockhouse, showing detail of the middle of the trench	NE
3270	1A	Post-excavation shot of the blockhouse, showing detail on the southern half of the trench	E
3271	1A	Post-excavation shot of the blockhouse, showing detail on the southern half of the trench	SW
3272	1A	Post-excavation shot of the blockhouse, showing detail of the south wall below the perimeter wall of the fort	S
3273	1A	Post-excavation shot of the blockhouse, showing detail of the south wall below the perimeter wall of the fort	S
3274	1A	Post-excavation shot of the blockhouse, showing detail on the southern half of the trench	W
3275	1A	Post-excavation shot of the blockhouse, showing detail on the southern half of the trench	W
3276	1A	Post-excavation shot of the blockhouse, showing detail on the southern half of the trench	W
3277	1A	Post-excavation shot of the blockhouse, showing detail of the north-west corner of the trench	NW
3278	1A	Post-excavation shot of the blockhouse, showing detail of the north-west corner of the trench	NW
3279	1A	Post-excavation shot of the blockhouse, showing detail in the northern half of the trench	NW
3280	1A	Post-excavation shot of the blockhouse, showing detail of the north-east corner of the trench	N
3281	1A	Post-excavation shot of the blockhouse, showing detail of the north-east corner of the trench	N
3282	1A	Post-excavation shot of the blockhouse, showing detail of the north-west corner of the trench	N
3283	1A	Post-excavation shot of the blockhouse	N
3284	1A	Post-excavation shot of the blockhouse, showing detail of the	NE

		north-east corner of the trench	
3285	1A	Post-excavation shot of the blockhouse, showing detail of the north-east corner of the trench	NE
3286	1A	Post-excavation shot of the blockhouse	N
3287	1A	Post-excavation shot of the blockhouse	N
3288	1A	Post-excavation shot of the blockhouse, showing detail of the north-west corner of the trench	NW
3289	1A	Post-excavation shot of the blockhouse, showing detail of the north-west corner of the trench	NW
3290	1A	Post-excavation shot of the blockhouse, showing detail of the north-west corner of the trench	NW
3291	1A	Post-excavation shot of the blockhouse, showing detail of the north-east corner of the trench	NE
3292	1A	Post-excavation shot of the blockhouse, showing detail of the north-east corner of the trench	NE
3293	1A	Post-excavation shot of the blockhouse, showing detail of the north-east corner of the trench	NE
3294	1A	Post-excavation shot of the blockhouse	NE
3295	1A	Post-excavation shot of the blockhouse, showing detail of the south wall below the perimeter wall of the fort	S
3296	1A	Post-excavation shot of the blockhouse, showing detail of the south wall below the perimeter wall of the fort	S
3297	1A	Post-excavation shot of the blockhouse, showing detail of the south wall below the perimeter wall of the fort	S
3298	1A	Post-excavation shot of the blockhouse, showing detail of the south wall below the perimeter wall of the fort	S
3299	1A	Post-excavation shot of the blockhouse, showing detail of the south wall below the perimeter wall of the fort	S
3300	1A	Post-excavation shot of the blockhouse, showing detail of the south-eastern stump of wall	W
3301	1A	Post-excavation shot of the blockhouse, showing detail of the eastern half of the trench	N
3302	1A	Post-excavation shot of the blockhouse, showing detail of the north-western corner	NW
3303	1A	Post-excavation shot of the blockhouse, showing detail of the southern half of the trench	E
3304	1A	Post-excavation shot of the blockhouse, showing detail of the western half of the trench	N
3305	1A	Post-excavation shot of blockhouse, showing detail of foundation trench c7 in north-western corner of trench	N
3306	1A	Post-excavation shot of blockhouse, showing detail of foundation trench c7 along the western wall of the blockhouse	W
3307	1A	Post-excavation shot of blockhouse, showing detail of foundation trench c7 in north-eastern corner of trench	N
3308	1A	Post-excavation shot of blockhouse, showing detail of foundation trench c7 in north-eastern corner of trench	N
3309	1A	Post-excavation shot of blockhouse, showing detail of foundation trench c7 along the north-western and north walls of the blockhouse	NW
3310	1A	Post-excavation shot of blockhouse, showing detail of foundation trench c7 along the north-eastern and north walls of the blockhouse	E
3311	1A	Post-excavation shot of blockhouse, showing detail of foundation trench c7 along the western wall of the blockhouse	S
3312	1A	Post-excavation shot of blockhouse, showing detail of foundation trench c7 in north-eastern corner of trench	E
3313	1A	Post-excavation shot of blockhouse, showing detail of foundation trench c7 in north-eastern corner of trench	S
3314	1A	Post-excavation shot of the blockhouse, showing detail of the	SW

		southern half of the trench	
3315	1A	Post-excavation shot of blockhouse, showing detail of foundation trench c7 in south-eastern corner of trench	S
3316	1A	Post-excavation shot of the blockhouse	NW
3317	1A	Post-excavation shot of the blockhouse	NW
3318	1A	Post-excavation shot of the blockhouse	NW
3319	1A	Post-excavation shot of blockhouse, showing detail of foundation trench c7 in south-eastern corner of trench	S
3320	1A	Post-excavation shot of blockhouse, showing detail of foundation trench c7 in south-eastern corner of trench	S
3321	1A	Post-excavation shot of blockhouse, showing detail of foundation trench c7 in south-eastern corner of trench	S
3322	1A	Post-excavation shot of blockhouse, showing detail of foundation trench c7 in south-eastern corner of trench	W
3323	1A	Post-excavation shot of blockhouse, showing detail of foundation trench c7 in south-eastern corner of trench	S
3324	1A	Post-excavation shot of blockhouse, showing detail of foundation trench c7 along the eastern wall of the blockhouse	N
3325	1A	Post-excavation shot of blockhouse, showing detail of foundation trench c7 along the eastern wall of the blockhouse	E
3326	1A	Post-excavation shot of blockhouse, showing detail of foundation trench c7 in north-eastern corner of trench	N
3327	1A	Post-excavation shot of blockhouse, showing detail of foundation trench c7 in south-eastern corner of trench	N
3328	1A	Post-excavation shot of blockhouse, showing detail of foundation trench c7 in south-eastern corner of trench	N
3329	1A	Post-excavation shot of blockhouse, showing detail of foundation trench c7 in south-eastern corner of trench	N
3330	1A	Post-excavation shot of blockhouse, showing detail of foundation trench c7 in south-eastern corner of trench	E
3331	1A	Post-excavation shot of blockhouse, showing detail of foundation trench c7 in south-eastern corner of trench	E
3332	1A	Post-excavation shot of blockhouse, showing detail of foundation trench c7 in south-eastern corner of trench	N
3333	1A	Post-excavation shot of blockhouse, showing detail of foundation trench c7 in south-eastern corner of trench	N
3334	1A	Post-excavation shot of blockhouse, showing detail of foundation trench c7 in south-eastern corner of trench	N
3335	1A	Post-excavation shot of blockhouse, showing detail of foundation trench c7 in south-eastern corner of trench	N
3336	1A	Post-excavation shot of blockhouse, showing detail of foundation trench c7 in south-eastern corner of trench	N
3337	1A	Post-excavation shot of blockhouse, showing detail of foundation trench c7 along the north wall	N
3338	1A	Post-excavation shot of blockhouse, showing detail of foundation trench c7 along the north wall	N
3339	1A	Post-excavation shot of blockhouse, showing detail of foundation trench c7 along the north wall	E
3340	1A	Post-excavation shot of blockhouse, showing detail of foundation trench c7 along the north wall	W
3341	1A	Post-excavation shot of blockhouse, showing detail of foundation trench c7 along the north wall	W
3342	1A	Post-excavation shot of blockhouse, showing detail of foundation trench c7 in north-western corner of trench	N
3343	1A	Post-excavation shot of blockhouse, showing detail of foundation trench c7 in north-western corner of trench	N
3344	1A	Post-excavation shot of blockhouse, showing detail of foundation trench c7 in north-western corner of trench	N
3345	1A	Post-excavation shot of blockhouse, showing detail of foundation	N

		trench c7 in north-western corner of trench	
3346	1A	Post-excavation shot of blockhouse, showing detail of foundation trench c7 in north-western corner of trench	W
3347	1A	Post-excavation shot of blockhouse, showing detail of foundation trench c7 in north-western corner of trench	W
3348	1A	Post-excavation shot of blockhouse, showing detail of foundation trench c7 along the west wall	W
3349	1A	Post-excavation shot of blockhouse, showing detail of foundation trench c7 along the west wall	W
3350	1A	Post-excavation shot of blockhouse, showing detail of foundation trench c7 in north-western corner of trench	N
3351	1A	Post-excavation shot of blockhouse, showing detail of foundation trench c7 in north-western corner of trench	N
3352	1A	Post-excavation shot of blockhouse, showing detail of foundation trench c7 in south-western corner of trench	W
3353	1A	Post-excavation shot of blockhouse, showing detail of foundation trench c7 in south-western corner of trench	W
3354	1A	Post-excavation shot of the blockhouse, showing detail of the western half of the trench	S
3355	1A	Post-excavation shot of the blockhouse, showing detail in the southern half of the trench	S
3356	1A	Post-excavation shot of blockhouse, showing detail of wall c5 in south-western corner of trench	S
3357	1A	Post-excavation shot of blockhouse, showing detail of wall c5 in south-western corner of trench	S
3358	1A	Post-excavation shot of blockhouse, showing detail of wall c5 in south-western corner of trench	S
3359	1A	Post-excavation shot of blockhouse, showing detail of foundation trench c7 along the west wall	E
3360	1A	Post-excavation shot of blockhouse, showing detail of foundation trench c7 along the west wall	N
3361	1B	Pre-excavation shot of the northern extension to the trench	NW
3362	1B	Pre-excavation shot of the northern extension to the trench	W
3363	1B	Pre-excavation shot of the northern extension to the trench	W
3364	1B	Pre-excavation shot of the northern extension to the trench	NE
3365	1B	Pre-excavation shot of the northern extension to the trench	E
3366	1B	Pre-excavation shot of the northern extension to the trench	E
3367	1B	Pre-excavation shot of the northern extension to the trench	N
3368	1A	Post-excavation shot of blockhouse, taken from perimeter wall	N
3369	1A	Post-excavation shot of blockhouse, taken from perimeter wall	N
3370	1A	Post-excavation shot of blockhouse, taken from perimeter wall	N
3371	1A	Post-excavation shot of blockhouse, taken from perimeter wall, showing detail of the southern half of the trench	N
3372	1A	Post-excavation shot of blockhouse, taken from perimeter wall, showing detail of the southern half of the trench	N
3373	1A	Post-excavation shot of blockhouse, taken from perimeter wall	N
3374	1A	Post-excavation shot of blockhouse, taken from perimeter wall	N
3375	1A	Post-excavation shot of blockhouse, taken from perimeter wall, showing detail of the southern half of the trench	N
3376	1A	Post-excavation shot of blockhouse, taken from perimeter wall, showing detail of the southern half of the trench	N
3377	1A	Post-excavation shot of blockhouse, taken from Trench 1B	N
3378	1A	Post-excavation shot of blockhouse, taken from Trench 1B	N
3379	1A	Post-excavation shot of blockhouse, taken from Trench 1B	N
3380	1B	Post-excavation shot of the trench, showing proximity to Trench 1A	NW
3381	1A	External shot of the north-eastern corner of the blockhouse, showing building technique	W
3382	1A	External shot of the north-eastern corner of the blockhouse,	S

		showing building technique	
3383	1A	Internal shot of the north-eastern corner of the blockhouse, showing detail of foundation trench c7 and imprint of shuttering	E
3384	1A	Internal shot of the north-eastern corner of the blockhouse, showing detail of foundation trench c7 and imprint of shuttering	E
3385	1A	General shot of the area around the trench	W
3386	N/A	Shot of shoreline defensive trenches to the north of Trenches 3 and 4	S
3387	N/A	Shot of shoreline defensive trenches to the north of Trenches 3 and 4	S
3388	N/A	Shot of shoreline defensive trenches to the north of Trenches 3 and 4	S
3389	N/A	Shot of shoreline defensive trenches to the north of Trenches 3 and 4	N
3390	N/A	Shot of shoreline defensive trenches to the north of Trenches 3 and 4	N
3391	3	Pre-excavation shot of the trench	S
3392	3	Pre-excavation shot of the trench	S
3393	3	Pre-excavation shot of the trench	S
3394	3	Pre-excavation shot of the trench	S
3395	3	Pre-excavation shot of the trench	S
3396	3	Pre-excavation shot of the trench	N
3397	3	Pre-excavation shot of the trench	N
3398	3	Pre-excavation shot of the trench	N
3399	3	Pre-excavation shot of the trench	N
3400	3	Pre-excavation shot of the trench	N
3401	3	Pre-excavation shot of the trench	N
3402	3	Pre-excavation shot of the trench, showing detail of the eastern side of the trench	NE
3403	3	Pre-excavation shot of the trench, showing detail of the western side of the trench	NW
3404	N/A	Shot of the shoreline defensive trenches between Trenches 3 and 4	S
3405	N/A	Shot of the shoreline defensive trenches between Trenches 3 and 4	S
3406	N/A	Shot of the shoreline defensive trenches between Trenches 3 and 4	S
3407	N/A	Shot of the shoreline defensive trenches between Trenches 3 and 4	S
3408	N/A	Shot of the shoreline defensive trenches between Trenches 3 and 4	S
3409	N/A	Shot of the shoreline defensive trenches between Trenches 3 and 4	S
3410	N/A	Shot of the shoreline defensive trenches between Trenches 3 and 4	S
3411	N/A	Shot of the shoreline defensive trenches between Trenches 3 and 4	S
3412	3	Pre-excavation shot of the trench, showing detail of the western side of the trench	S
3413	3	Pre-excavation shot of the trench, showing detail of the western side of the trench	S
3414	3	Pre-excavation shot of the trench, showing detail of the eastern side of the trench	S
3415	3	Pre-excavation shot of the trench, showing detail of the eastern side of the trench	S
3416	N/A	Shot of the shoreline defensive trenches between Trenches 3 and 4	N
3417	3	Pre-excavation shot of the trench, showing detail of the eastern	NE

		side of the trench	
3418	3	Pre-excavation shot of the trench, showing detail of the western side of the trench	NW
3419	3	Pre-excavation shot of the trench	N
3420	N/A	Shot of the shoreline defensive trenches between Trenches 3 and 4	S
3421	N/A	Shot of the shoreline defensive trenches between Trenches 3 and 4	S
3422	N/A	Shot of the shoreline defensive trenches between Trenches 3 and 4	S
3423	4	Pre-excavation shot of the trench	S
3424	4	Pre-excavation shot of the trench	S
3425	4	Pre-excavation shot of the trench	S
3426	4	Pre-excavation shot of the trench	S
3427	4	Pre-excavation shot of the trench	S
3428	4	Pre-excavation shot of the trench	S
3429	4	Pre-excavation shot of the trench	S
3430	4	Pre-excavation shot of the trench	S
3431	4	Pre-excavation shot of the trench, showing detail of the dugout	E
3432	4	Pre-excavation shot of the trench, showing detail of the dugout	E
3433	4	Pre-excavation shot of the trench, showing detail of the dugout	S
3434	4	Pre-excavation shot of the trench, showing detail of the dugout	S
3435	4	Pre-excavation shot of the trench, showing detail of the dugout	E
3436	4	Pre-excavation shot of the trench, showing detail of the dugout	SE
3437	4	Pre-excavation shot of the trench, showing detail of the dugout	S
3438	4	Pre-excavation shot of the trench, showing detail of the dugout	SE
3439	4	Pre-excavation shot of the trench	NE
3440	4	Pre-excavation shot of the trench	S
3441	4	Pre-excavation shot of the trench	E
3442	4	Pre-excavation shot of the trench	E
3443	4	Pre-excavation shot of the trench	S
3444	4	Pre-excavation shot of the trench	NE
3445	4	Pre-excavation shot of the trench	NE
3446	4	Pre-excavation shot of the trench, showing detail of the south wall of the dugout	S
3447	4	Pre-excavation shot of the trench, showing detail of the south-eastern corner of the dugout	SE
3448	4	Pre-excavation shot of the trench, showing detail of the north-eastern corner of the dugout	NE
3449	4	Pre-excavation shot of the trench, showing detail of the north wall of the dugout	N
3450	4	Pre-excavation shot of the trench, showing detail of the north wall of the dugout	N
3451	4	Pre-excavation shot of the trench	S
3452	4	Pre-excavation shot of the trench	S
3453	4	Pre-excavation shot of the trench, showing detail of the east wall of the dugout	E
3454	4	Pre-excavation shot of the trench, showing detail of the north wall of the dugout	NE
3455	4	Pre-excavation shot of the trench	N
3456	4	Pre-excavation shot of the trench	N
3457	4	Pre-excavation shot of the trench	N
3458	4	Pre-excavation shot of the trench	SE
3459	4	Pre-excavation shot of the trench	SE
3460	4	Pre-excavation shot of the trench	E
3461	N/A	Shot of the shoreline defensive trenches	N
3462	4	Pre-excavation shot of the trench	SE
3463	4	Pre-excavation shot of the trench	E

3464	4	Pre-excavation shot of the trench	E
3465	4	Pre-excavation shot of the trench	NE
3466	4	Pre-excavation shot of the trench	N
3467	4	Pre-excavation shot of the trench	N
3468	4	Pre-excavation shot of the trench	N
3469	4	Pre-excavation shot of the trench	N
3470	1A	Location shot of the trench from the north-eastern perimeter wall	W
3471	1A	Location shot of the trench moving west along the perimeter wall	W
3472	1A	Location shot of the trench moving west along the perimeter wall	W
3473	1A	Location shot of the trench moving west along the perimeter wall	W
3474	1A	Location shot of the trench moving west along the perimeter wall	W
3475	1A	Location shot of the trench moving west along the perimeter wall	W
3476	1A	Location shot of the trench moving west along the perimeter wall	W
3477	1A	Location shot of the trench	E
3478	1A	Location shot of the trench	E
3479	1A	Location shot of the trench	E
3480	1A	Location shot of the trench	E
3481	1A	Location shot of the trench	E
3482	1A	Location shot of the trench from the north-western corner of the perimeter wall	E
3483	1A	Location shot of the trench from the north-western corner of the perimeter wall	E
3484	3	Pre-excavation view of the trench following the removal of the vegetation	S
3485	3	Pre-excavation view of the trench following the removal of the vegetation	SW
3486	4	Working shot of excavations within this trench	S
3487	1B	Mid-excavation shot following removal of c1008	S
3488	1B	Mid-excavation shot following removal of c1008	E
3489	1B	Mid-excavation shot following removal of c1008	W
3490	1B	Mid-excavation shot following removal of c1008	N
3491	1B (NE)	Mid-excavation shot of surfaces of c1027, c1028, and c1029, as well as bedrock c1018	SE
3492	1B (NE)	Mid-excavation shot of surfaces of c1027, c1028, and c1029, as well as bedrock c1018	NE
3493	1B (NE)	Mid-excavation shot of surfaces of c1027, c1028, and c1029, as well as bedrock c1018	NW
3494	1B (NE)	Mid-excavation shot of surfaces of c1027, c1028, and c1029, as well as bedrock c1018	NW
3495	N/A	Carrickfergus Castle viewed from the terrace below the artillery guns	N/A
3496	N/A	Carrickfergus Castle viewed from the terrace below the artillery guns	N/A
3497	N/A	Carrickfergus Castle viewed from the terrace below the artillery guns	N/A
3498	N/A	Carrickfergus Castle viewed from the terrace below the artillery guns	N/A
3504	4	Working shot of excavations within this	N
3505	3	Mid-excavation shot showing surface of c306	N
3506	3	Mid-excavation shot showing surface of c306	N
3507	3	Mid-excavation shot of the full trench	N
3508	3	Mid-excavation shot showing surface of c306	S
3509	3	Mid-excavation shot showing surface of c306	S
3510	3	Mid-excavation shot of the full trench	S
3511	3	Mid-excavation shot showing surface of c306	W
3512	3	Mid-excavation view of the west bank of the trench	W
3513	3	Mid-excavation view of the west bank of the trench	W
3514	3	Mid-excavation shot of the full trench	E

3515	3	Mid-excavation view of the east bank of the trench	E
3516	3	Mid-excavation shot of the full trench	E
3517	3	Mid-excavation shot of drain feature c303 in the east bank of the trench	E
3518	3	Mid-excavation shot of drain feature c303 in the east bank of the trench	E
3519	2	Post-excavation shot of the trench, showing surface of the natural subsoil c210 and services cables c211	S
3520	2	Post-excavation shot of the trench, showing surface of the natural subsoil c210 and services cables c211	S
3521	2	Post-excavation shot of the trench, showing surface of the natural subsoil c210 and services cables c211	S
3522	2	Post-excavation shot of the trench, showing surface of the natural subsoil c210 and services cables c211	S
3523	2	Post-excavation shot of the trench, showing surface of the natural subsoil c210 and services cables c211	S
3524	2	Post-excavation shot of the trench, showing surface of the natural subsoil c210 and services cables c211	S
3525	2	Post-excavation shot of the trench, showing surface of the natural subsoil c210 and services cables c211	S
3526	2	Post-excavation shot of the trench, showing surface of the natural subsoil c210 and services cables c211	N
3527	2	Post-excavation shot of the trench, showing surface of the natural subsoil c210 and services cables c211	N
3528	2	Post-excavation shot of the trench, showing surface of the natural subsoil c210 and services cables c211	N
3529	2	Post-excavation shot of the trench, showing surface of the natural subsoil c210 and services cables c211	N
3530	2	West facing section of the trench	E
3531	2	Post-excavation shot of service cables c211 and associated cut c213	E
3532	2	Post-excavation shot of service cables c211 and associated cut c213	N
3533	2	Post-excavation shot of service cables c211 and associated cut c213	N
3534	2	Post-excavation shot of service cables c211 and associated cut c213	W
3535	2	Post-excavation shot of service cables c211 and associated cut c213	W
3536	2	West facing section of the trench	E
3537	2	West facing section of the trench	E
3538	2	East facing section of the trench	W
3539	2	East facing section of the trench	W
3540	2	East facing section of the trench	W
3541	2	East facing section of the trench	W
3542	2	West facing section of the trench	E
3543	2	West facing section of the trench	E
3544	1B (NE)	South-west facing elevation of the extension	NE
3545	1B (NE)	South-west facing elevation of the extension	NE
3546	1B (NE)	South-west facing elevation of the western half of the extension	ENE
3547	1B (NE)	South-west facing elevation of the western half of the extension	ENE
3548	1B (NE)	South-west facing elevation of the northern half of the extension	NNE
3549	1B (NE)	South-west facing elevation of the northern half of the extension	NNE
3550	1B (NE)	South-east facing section of the trench	NW
3551	1B (NE)	South-east facing section of the trench	NW
3552	1B (NE)	North-west facing section of the trench	SE
3553	1B (NE)	North-west facing section of the trench	SE
3554	1B (NE)	North-west facing section of the trench	SE



3555	1B (NE)	South-east facing section of the trench	NW
3556	1B (NE)	South-east facing section of the trench	NW
3557	1B (NE)	North-east facing section of the trench	WSW
3558	1B (NE)	North-east facing section of the trench	WSW
3559	1B (NE)	Post-excavation shot of the east corner of the extension	NW
3560	1B (NE)	Post-excavation shot of the north corner of the extension	NW
3561	1B (NE)	Post-excavation shot of the north corner of the extension	SE
3562	1B (NE)	Post-excavation shot of the extension	E
3563	1B (NE)	Post-excavation shot of the extension	NE
3564	1B (NE)	Post-excavation shot of the extension	NE
3565	1B (NE)	Post-excavation shot of the extension	N
3566	1B (NE)	Post-excavation shot of the extension	N
3567	1B (NE)	Post-excavation shot of the extension	N
3568	1B (NE)	Post-excavation shot of the extension	N
3569	1B (NE)	Post-excavation shot of the extension	NE
3570	1B (NE)	Post-excavation shot of the extension	NE
3571	1B (NE)	East facing section of the extension	NE
3572	1B (NE)	West facing section of the extension	E
3573	1B (NE)	West facing section of the extension	E
3574	1B (NE)	West and north facing sections of the extension	SW
3575	1B (NE)	East facing section of the extension	SE
3576	1B (NE)	North and east facing sections of the extension	S
3577	1B (NE)	North facing section of the extension	S
3578	1B (NE)	North facing section of the extension	S
3579	1B (NE)	North facing section of the extension	S
3580	1B (NE)	Post-excavation shot of the southern half of the extension	In plan
3581	1B (NE)	Post-excavation shot of the southern half of the extension	In plan
3582	1B (NE)	Post-excavation shot of the northern half of the extension	In plan
3583	1B (NE)	Post-excavation shot of the northern half of the extension	In plan
3584	1B (NE)	Post-excavation shot of the north-west corner of the extension	In plan
3585	1B (NE)	Post-excavation shot of the north-west corner of the extension	In plan
3586	1B (NE)	Post-excavation shot of the north-east corner of the extension	In plan
3587	1B (NE)	Post-excavation shot of the north-east corner of the extension	In plan
3588	N/A	Working shot	N/A
3589	N/A	Working shot	N/A
3590	1B (SW)	South-east facing section of the extension	SW
3591	1B (SW)	South-west facing section of the extension	SE
3592	1B (SW)	North-east facing section of the extension	SW
3593	1B (SW)	South-west facing section of the extension	NE
3594	1B (SW)	Post-excavation shot of the extension	NE
3595	VOID	VOID	VOID
3596	VOID	VOID	VOID
3597	VOID	VOID	VOID
3598	VOID	VOID	VOID
3599	VOID	VOID	VOID
3600	VOID	VOID	VOID
3601	1B	Post-excavation shot of Trench 1B	NE
3602	1B	Post- excavation shot of Trench 1B	NE
3603	1B/ 1B (SW)	East-facing section of Trench 1B and the south-west extension	W
3604	1B/ 1B (SW)	West-facing section of Trench 1B and the south-west extension	E
3605	1B/ 1B (SW)	West-facing section of Trench 1B and the south-west extension	E
3607	1B	Post-excavation shot of trench	S
3607	1B	Post-excavation shot of trench	S
3608	1B	Post-excavation shot of trench	S
3609	1B	Working shot of excavations in Trench 1B	SW

3610	1B	Post-excavation shot of Trench 1B and its extensions to the north-east and south-west	S
3611	1B	Post-excavation shot of Trench 1B and its extensions to the north-east and south-west	S
3612	1B	Post-excavation shot of Trench 1B and its extension to the north-east	S
3613	2	West facing section of the trench	E
3614	2	West facing section of the trench	E
3615	2	West facing section of the trench	E
3616	2	West facing section of the trench	E
3617	2	East facing section of the trench	W
3618	2	East facing section of the trench	W
3619	2	East facing section of the trench	W
3620	2	East facing section of the trench	W
3621	2	East facing section of the trench	W
3622	4	Mid-excavation shot following the removal of c401	S
3623	4	Mid-excavation shot following the removal of c401	S
3624	3	South facing section through the floor of the "trench"	N
3625	3	East bank of the "trench" following the removal of c300	S
3626	3	East bank of the "trench" following the removal of c300	N
3627	3	East bank of the "trench" following the removal of c300, showing the drain c303	W
3628	3	Drain c303 on the sea-side of the east bank of the "trench"	W
3629	3	Drain c303 on the sea-side of the east bank of the "trench"	N
3630	3	Working shot of excavations within the trench	W
3631	3	Working shot of excavations within the trench	W
3632	3	Working shot of excavations within the trench	W
3633	3	Working shot of excavations within the trench	W
3634	3	Working shot of excavations within the trench	W
3635	4	Working shot of excavations within the trench	W
3636	4	Working shot of excavations within the trench	W
3637	3	Working shot of excavations within the trench	W
3638	4	Mid-excavation shot following the removal of c401	S
3639	4	Mid-excavation shot following the removal of c401	S
3640	4	Mid-excavation shot following the removal of c401	N
3641	4	Mid-excavation shot following the removal of c401	N
3642	4	Mid-excavation shot following the removal of c401	N
3643	4	Mid-excavation shot following the removal of c401	N
3644	4	Mid-excavation shot of the dugout interior following the removal of c401	E
3645	4	Mid-excavation shot of the dugout interior following the removal of c401	E
3646	4	Mid-excavation shot of the dugout interior following the removal of c401	E
3647	4	Mid-excavation shot of the dugout interior following the removal of c401	E
3648	4	Mid-excavation shot of the metal/iron on the floor of the dugout	In plan
3649	4	Mid-excavation shot of the metal/iron on the floor of the dugout	In plan
3650	4	Mid-excavation shot of the wriggley tin in the south-west corner of the dugout	In plan
3651	4	Mid-excavation shot of the wriggley tin in the south-west corner of the dugout	In plan
3652	4	Mid-excavation shot of the wriggley tin in the south-east corner of the dugout	In plan
3653	4	Mid-excavation shot of the wriggley tin in the south-east corner of the dugout	In plan
3654	4	Mid-excavation shot of the wriggley tin within the dugout	In plan
3655	4	Mid-excavation shot of the wriggley tin within the dugout	In plan

3656	4	Mid-excavation shot of the wriggley tin within the dugout	In plan
3657	4	Mid-excavation shot of the wriggley tin within the dugout	In plan
3658	4	Mid-excavation shot of the east wall of the dugout, showing the stone revetting and wriggley tin	E
3659	4	Mid-excavation shot of the east wall of the dugout, showing the stone revetting and wriggley tin	E
3660	4	Mid-excavation shot of the entrance of the dugout	E
3661	4	Mid-excavation shot of the entrance of the dugout	E
3662	3	Working shot looking seaward over the top of the east bank	E
3663	3	Working shot looking seaward over the top of the east bank	E
3664	3	Working shot looking seaward over the top of the east bank	E
3665	3	Working shot looking seaward over the top of the east bank	E
3666	4	Working shot of excavations within this trench	E
3667	4	Working shot of excavations within this trench	E
3668	4	Working shot of excavations within this trench	E
3669	3	Working shot of excavations within this trench	N
3670	3	Pre-excavation shot of drain c309 in base of trench with stones emerging from the east bank	W
3671	3	Pre-excavation shot of drain c309 in base of trench with stones emerging from the east bank	W
3672	3	Pre-excavation shot of drain c309 in base of trench with stones emerging from the east bank	W
3673	3	Pre-excavation shot of drain c309 in base of trench	N
3674	3	Pre-excavation shot of drain c309 in base of trench	N
3675	3	Working shot of excavations within this trench	S
3676	3	Working shot of excavations within this trench	S
3677	3	Pre-excavation shot of drain c309 in base of trench with stones in east bank	E
3678	3	Pre-excavation shot of drain c309 in base of trench with stones in east bank	E
3679	3	Pre-excavation shot of drain c309 in base of trench with stones in east bank	E
3680	3	Pre-excavation shot of drain c309 in base of trench with stones in east bank	E
3681	3	Pre-excavation shot of drain c309 in base of trench with stones in east bank	E
3682	3	Pre-excavation shot of drain c309 in base of trench with stones in east bank	E
3683	3	Pre-excavation shot of drain c309 in base of trench with stones in east bank	E
3684	3	Pre-excavation shot of drain c309 in base of trench with stones in east bank	E
3685	3	Pre-excavation shot of drain c309 in base of trench with stones in east bank	E
3686	3	Pre-excavation shot of drain c309 in base of trench with stones in east bank	E
3687	3	Pre-excavation shot of drain c309 in base of trench with stones in east bank	E
3688	3	Pre-excavation shot of drain c309 in base of trench with stones in east bank	E
3689	N/A	Flooding in the sea defences trench, north of path at the search light	N/A
3690	N/A	Flooding in the sea defences trench, north of path at the search light	N/A
3691	N/A	Flooding in the sea defences trench, south of path at the search light	N/A
3692	N/A	Flooding in the sea defences trench, south of path at the search light	N/A
3693	N/A	Flooding in the sea defences trench, south of path at the search	N/A

		light	
3694	3	Working shot of excavations within this trench	W
3695	3	Mid-excavation shot of the trench system, prior to excavation of drain c309 in base of trench	S
3696	3	Mid-excavation shot of the trench system, prior to excavation of drain c309 in base of trench	S
3697	3	Mid-excavation shot of the trench system, prior to excavation of drain c309 in base of trench	S
3698	3	Post-excavation shot of the east side of the trench system, showing drain c309	W
3699	3	Post-excavation shot of the east side of the trench system, showing detail of drain c309	N
3700	3	Post-excavation shot of the east side of the trench system, showing detail of drain c309	N
3701	3	Post-excavation shot of the east side of the trench system, showing detail of drain c309	W
3702	3	Mid-excavation shot of drain c309 in the base of the trench	N
3703	3	Mid-excavation shot of drain c309 in the base of the trench	S
3704	3	Mid-excavation shot of drain c309 in the base of the trench	S
3705	VOID	VOID	VOID
3706	VOID	VOID	VOID
3707	VOID	VOID	VOID
3708	VOID	VOID	VOID
3709	VOID	VOID	VOID
3710	VOID	VOID	VOID
3711	VOID	VOID	VOID
3712	VOID	VOID	VOID
3713	VOID	VOID	VOID
3714	VOID	VOID	VOID
3715	VOID	VOID	VOID
3716	VOID	VOID	VOID
3717	VOID	VOID	VOID
3718	VOID	VOID	VOID
3719	VOID	VOID	VOID
3720	3	Post-excavation shot of drain c309 in the base of the trench	S
3721	3	Post-excavation shot of drain c309 in the base of the trench	S
3722	3	Post-excavation shot of drain c309 in the base of the trench	S
3723	3	Post-excavation shot of drain c309 in the base of the trench	E
3724	3	Post-excavation shot of drain c309 in the base of the trench	E
3725	3	Post-excavation shot of drain c309 in the base of the trench	E
3726	3	Post-excavation shot of drain c309 in the base of the trench	E
3727	3	Post-excavation shot of drain c309 in the base of the trench	E
3728	3	Post-excavation shot of drain c309 in the base of the trench	E
3729	3	Post-excavation shot of drain c309 in the base of the trench	E
3730	3	Post-excavation shot of drain c309 in the base of the trench	E
3731	3	Post-excavation shot of drain c309 in the base of the trench	E
3732	3	Post-excavation shot of drain c309 in the base of the trench	E
3733	3	Post-excavation shot of drain c309 in the base of the trench	E
3734	3	Post-excavation shot of drain c309 in the base of the trench	E
3735	3	Post-excavation shot of drain c309 in the base of the trench	E
3736	3	Post-excavation shot of drain c309 in the base of the trench	E
3737	3	Post-excavation shot of drain c309 in the base of the trench	NE
3738	3	Post-excavation shot of drain c309 in the base of the trench	NE
3739	3	Post-excavation shot of drain c309 in the base of the trench	N
3740	3	Post-excavation shot of drain c309 in the base of the trench	NE
3741	3	Post-excavation shot of drain c309 in the base of the trench	N
3742	3	Post-excavation shot of drain c309 in the base of the trench	N
3743	3	Post-excavation shot of drain c309 in the base of the trench	N

3744	4	Mid-excavation shot of the dugout following the removal of c404	E
3745	4	Mid-excavation shot of the dugout following the removal of c404	E
3746	4	Mid-excavation shot of the dugout following the removal of c404	E
3747	4	Mid-excavation shot of the dugout following the removal of c404	E
3748	4	Mid-excavation shot of the dugout following the removal of c404	E
3749	4	Mid-excavation shot of the dugout following the removal of c404	E
3750	4	Mid-excavation shot of the dugout following the removal of c404	E
3751	4	Mid-excavation shot of the dugout following the removal of c404	E
3752	4	Mid-excavation shot of the entrance of the dugout following the removal of c404	E
3753	4	Mid-excavation shot of the entrance of the dugout following the removal of c404	E
3754	4	Mid-excavation shot showing detail of the entrance of the dugout following the removal of c404	E
3755	4	Mid-excavation shot showing detail of the entrance of the dugout following the removal of c404	E
3756	4	Mid-excavation shot of the dugout following the removal of c404	S
3757	4	Mid-excavation shot of the dugout following the removal of c404	S
3758	4	Mid-excavation shot of the dugout following the removal of c404	S
3759	4	Mid-excavation shot of the dugout following the removal of c404	S
3760	4	Mid-excavation shot of the dugout following the removal of c404	N
3761	4	Mid-excavation shot of the dugout following the removal of c404	N
3762	N/A	Exterior of the fort, showing location of Trench 2, following backfilling	NE
3763	N/A	Exterior of the fort, showing location of Trench 2, following backfilling	NE
3764	N/A	Exterior of the fort, showing location of Trench 2, following backfilling	SE
3765	N/A	Exterior of the fort, showing location of Trench 2, following backfilling	SW
3766	N/A	Exterior of the fort, showing location of Trench 2, following backfilling	SW
3767	N/A	Exterior of the fort, showing location of Trench 2, following backfilling	SW
3768	N/A	Exterior of the fort, showing location of Trench 1A, following backfilling	E
3769	N/A	Exterior of the fort, showing location of Trench 1A, following backfilling	E
3770	N/A	Trench 1A, following backfilling	NE
3771	N/A	Trench 1A, following backfilling	NE
3772	N/A	Trench 1A, following backfilling	N
3773	N/A	Trench 1A, following backfilling	NW
3774	N/A	Exterior of the fort, looking at the apex	S
3775	N/A	Exterior of the fort, looking at the apex	S
3776	N/A	Exterior of the fort, looking at the apex	S
3777	N/A	Exterior of the fort, showing location of Trench 1A, following backfilling	NW
3778	N/A	Exterior of the fort, showing location of Trench 1A, following backfilling	W
3779	N/A	Exterior of the fort, showing location of Trench 1A, following backfilling	NW
3780	N/A	Exterior of the fort, looking away from Trench 1A	SE
3781	N/A	Exterior of the fort, showing location of Trench 1A, following backfilling	NW
3782	N/A	Exterior of the fort, showing location of Trench 1A, following backfilling	NW
3783	N/A	Exterior of the western side of the fort	SW
3784	N/A	Exterior of the western side of the fort	SW

3785	N/A	Exterior of the western side of the fort	NE
3786	N/A	Exterior of the western side of the fort	NE
3787	N/A	Exterior of the western side of the fort	NE
3788	N/A	Exterior of the southern side of the fort, west of the entrance	NW
3789	N/A	Exterior of the southern side of the fort, west of the entrance	NW
3790	N/A	Exterior of the southern side of the fort, west of the entrance	SE
3791	N/A	Exterior of the southern side of the fort, west of the entrance	SE
3792	N/A	Entrance of the fort	NE
3793	N/A	Entrance of the fort, looking towards the radar platform	NE
3794	N/A	Entrance of the fort, looking towards the gun store	NE
3795	N/A	Exterior of the southern side of the fort, east of the entrance	NW
3796	N/A	Exterior of the southern side of the fort, east of the entrance	NW
3797	N/A	Exterior of the southern side of the fort, east of the entrance	NW
3798	N/A	Exterior of the southern side of the fort, east of the entrance	NW
3799	N/A	Exterior of the southern side of the fort, east of the entrance	SE
3800	N/A	Exterior of the southern side of the fort, east of the entrance	SE
3801	N/A	Exterior of the southern side of the fort, east of the entrance	SE
3802	N/A	Interior of the fort, just past the magazine	NE
3803	N/A	Interior of the fort, showing location of Trench 1B, following backfilling	NW
3804	N/A	Interior of the fort, showing location of Trench 1B, following backfilling	NW
3805	N/A	Interior of the fort, showing location of Trench 1B, following backfilling	NW
3806	N/A	Interior of the fort, showing location of Trench 1B, following backfilling	NW
3807	N/A	Interior of the fort, showing location of Trench 1B, following backfilling	NW
3808	N/A	Interior of the fort, showing location of Trench 1B, following backfilling	N
3809	N/A	Interior of the fort, showing location of Trench 1B, following backfilling	N
3810	N/A	Interior of the fort, showing location of Trench 1B, following backfilling	N
3811	N/A	Interior of the fort, showing location of Trench 1B, following backfilling	NW
3812	N/A	Interior of the fort, showing location of Trench 1B, following backfilling	NE
3813	N/A	Interior of the fort, showing location of Trench 1B, following backfilling	NE
3814	N/A	Interior of the fort, showing location of Trench 1B, following backfilling	E
3815	N/A	Interior of the fort, showing location of Trench 1B, following backfilling	E
3816	N/A	Interior of the fort, showing location of Trench 1B, following backfilling	E
3817	N/A	Interior of the fort, showing location of Trench 1B, following backfilling	NE
3818	N/A	Interior of the fort, showing location of Trench 1B, following backfilling	NE
3819	N/A	Interior of the fort, showing location of Trench 1B, following backfilling	N
3820	N/A	Interior of the fort, showing location of Trench 1B, following backfilling	N
3821	N/A	Interior of the fort, showing location of Trench 1B, following backfilling	NW
3822	N/A	Interior of the fort, showing location of Trench 1B, following backfilling	NW

3823	N/A	Interior of the fort, showing location of Trench 1B, following backfilling	N
3824	N/A	Interior of the fort, looking up the path towards the entrance	SW
3825	N/A	Interior of the fort, looking up the path towards the entrance	SW

**Appendix 5. Small Finds Register**

<b>Grey Point Fort 2014 - Finds Register</b>			
<b>Trench</b>	<b>Context</b>	<b>Description</b>	<b>Quantity</b>
1A	1	Glass	4
1A	1	Complete Glass Bottle	1
1A	2	Glass	5
1A	2	Iron Metalwork	1
1A	3	Flint	14
1A	6	Pottery	1
1A	6	Glass	12
1A	6	Complete Glass Bottle	2
1A	6	Animal Bone	2
1A	6	Flint	4
1A	6	Base of Shotgun Shell	1
1A	6	Modern Bottle Caps and Ring Pull	9
1A	6	Iron Metalwork	10
1A	8	Flint	2
1A	8	Iron Metalwork	1
1B	1001	Pottery	1
1B	1001	Glass	3
1B	1001	Flint	41
1B	1001	Brick Fragments	1
1B	1001	Slate Fragments	4
1B	1001	Metal Pipe Fitting	1
1B	1001	Barbed Wire	32
1B	1001	Barbed Wire	12
1B	1001	Modern Can	1
1B	1001	Modern Foil	1
1B	1002	Glass	14
1B	1002	Modern Can	1
1B	1002	Modern Foil	1
1B	1005	Animal Bone	1
1B	1005	Flint	4
1B	1005	Metal Cable	1
1B	1005	Nails	3
1B	1005	Barbed Wire	36
1B	1007	Iron Metalwork	21
1B	1007	Barbed Wire	20
1B	1007	Modern Plastic	1
1B	1008	Clay Pipe	1
1B	1008	Glass	2
1B	1008	Flint	12
1B	1008	Concrete	1
1B	1008	Clinker	1



1B	1008	Brick Fragments	2
1B	1008	Iron Metalwork	3
1B	1008	Wriggly Tin Fragments	250
1B	1008	Modern Plastic	2
1B	1009	Pottery	1
1B	1009	Glass	1
1B	1009	Animal Bone	1
1B	1009	Flint	6
1B	1009	Wriggly Tin Fragments	1
1B	1010	Flint	6
1B	1010	Burnt Clay	0.994kg
1B	1010	Iron Metalwork	4
1B	1011	Flint	11
1B	1013	Barbed Wire Fence Pickets	2
1B	1014	Bitumen	1.832kg
1B	1016	Flint	35
1B	1016	Iron Metalwork	7
1B	1017	Pottery	1
1B	1017	Glass	2
1B	1017	Flint	18
1B	1017	Brick Fragments	8
1B	1017	Clinker	4
1B	1017	Iron Metalwork	4
1B	1017	Slag	3
1B	1020	Flint	10
1B	1020	Mortar	1
1B	1020	Brick Fragments	9
1B	1020	Iron Metalwork	30
1B	1022	Pottery	1
1B	1022	Flint	4
1B	1022	Brick Fragments	2
1B	1023	Pottery	1
1B	1023	Brick Fragments	2
1B	1023	Iron Metalwork	3
1B	1023	Modern Ring Pull	1
1B	1023	Modern Plastic	1
1B	1024	Flint	1
1B	1024	Brick Fragments	1
1B	1024	Mortar	3
1B	1024	Metal Bottle Cap	1
1B	1024	Iron Metalwork	25
1B	1024	Wriggly Tin Fragments	26
1B	1024	Barbed Wire	11
1B	1024	Modern Foil	2
1B	1025	Flint	6

1B (SW Ext)	1025	Iron Metalwork	2
1B	1026	Pottery	1
1B	1026	Complete Glass Bottle	1
1B	1026	Flint	9
1B	1026	Brick Fragments	8
	1026	Complete Brick	1
1B	1026	Slate Fragments	1
1B (SW Ext)	1026	Iron Metalwork	5
1B	1027	Flint	4
1B	1030	Slate Fragments	2
1B	1030	Iron Metalwork	2
2	204	Pottery	7
2	204	Glass	1
2	204	Flint	5
2	204	Iron Metalwork	3
2	204	Iron Base Plate	1
2	204	Barbed Wire	3
2	205	Pottery	18
2	205	Glass	1
2	205	Flint	24
2	205	Flint Scraper	1
2	205	Brick Fragments	2
2	205	Metal Bolts	9
2	205	Iron Metalwork	16
2	205	Barbed Wire	21
2	205	Green Stone	5
2	205	Barbed Wire Fence Pickets	2
2	206	Half Brick	1
2	206	Half Brick with Concrete	1
2	208	Ceramic Pipe Fragment	1
2	208	Metal Bolts	2
2	208	Barbed Wire	10
2	212	Animal Bone	2
2	212	Metal Cable	1
2	212	Metal Bolts	1
2	Unstratified	Flint	4
3	300	Pottery	1
3	300	Flint	16
3	301	Flint	23
3	302	Complete Glass Bottle	1
3	302	Flint	18
3	302	Iron Metalwork	4
3	304	Flint	4

3	305	Flint	9
3	307	Flint	3
4	401	Flint	14
4	402	Wriggly Tin Fragments	44
4	403	Wriggly Tin Fragments	4
4	403	Iron Metalwork	1
4	403	Barbed Wire	1
4	404	Flint	7
4	404	Wriggly Tin Fragments	55
4	404	.22 Shell Casings	8
Unstrat.	Unstratified	Flint	1