

# ULSTER ARCHAEOLOGICAL SOCIETY



**Survey Report: No. 27**

**Patterson's Spade Mill  
UAS/10/05**



*National Trust*

**In association with**



**MICHAEL CATNEY**

© Ulster Archaeological Society  
First published 2013

Ulster Archaeological Society  
c/o School of Geography, Archaeology and Palaeoecology  
Queen's University  
Belfast  
BT7 1NN

## CONTENTS

---

	page
List of figures	iii
List of tables	iv
1. Summary	1
2. Credits and Acknowledgements	2
3. Introduction	2
4. Survey	5
5. Discussion	6
6. Post Script	32
Bibliography	33
Appendices	
1. Water Power Calculations	34
2. Griffith Valuation Return of 25 March 1862.	35
3. Photographic record	36

## LIST OF FIGURES

Figures	page
1. Survey in progress at Patterson’s Spade Mill cottages	2
2. location of Patterson’s Spade Mill, Co. Antrim, BT39 0AP	3
3. section of James Crow map 1767 – 1770: Ballyrobert and Carnanee Townland (Td)	4
4. Ordnance Survey 6 inch Co. Antrim map tile 51 series – 1831 to 1921	5
5. possible layout of Flax and Corn Mills in 1836	7
6. View of South wall of the Corn Mill (Showing the Flume passing through the building.)	9
7. Paper Mill installation – changes in line with 1862 Valuation Return	11
8. Schematic representation of 19th Century Paper Making process	12
9. representation of the Mill complex in accordance with the 1901 OS map	13
10. single story roofed Paper Mill Machine Room facing East with remains of South Wall of Rag Store and Engine Room	14
11. Spade Mill complex in accordance with the 1921 OS map	15
12. Spade Mill complex up to 1977 (OS - 11inch map.)	16
13. Tilt Hammer	16
14. Tilt Hammer in operation	16
15. Tilt Hammer Drive schematic	17
16. Patterson’s Spade Mill manufacturing process simplified Flow Diagram	18
17. traditional Vertical Water Wheels	19
18. cut-away view of Patterson’s Spade Mill Leffel Turbine	21
19. James Thomson Vortex Turbine	22
20. Francis Turbine diagram	23
21. possible arrangement of 25ft Waterwheel in 1837	23
22. Patterson’s Spade Mill Cottages c1962	24
23. Plan of cottages - UAS survey 2010	24
24. Ruins of cottages viewed from the south	25
25. Griffiths Primary valuation map c1862-64	30

## **List of Tables**

Table 1	Valuators Return for Carnanee Td, dated 28 January 1836	7
Table 2	extract - Griffith Primary Valuation table published 1862	28
Table 3	extract from First Revision of the Primary Valuation taken in May 1864	29

## 1. Summary

*“Before 1750 most, if not all, of the spades used in Ireland were made by blacksmiths. The first documentary mention of a spade mill was in the late 1760s, and by the early to mid-1800 the majority of spades were produced in specialised mills.*

*The Patterson’s spade mill was the last mill in Ireland to produce spades by the traditional method using water-powered tilt hammer. The Patterson family had been spade makers for five or more generations and were first recorded as making spades at Ballyronan in 1781. They made spades at Carnanee from just after the first World war, ceasing production in 1990 when Robert, the last active Patterson spade maker, died. After his death, the family decided to sell the mill, as none of the relatives intended to make spade. The long family tradition had come to an end’.* (Coulter, M, 1995, 96)

Before these premises were put to spade making a history of mill working of various kinds had existed almost continuously, with only a few breaks due to change of ownership and purpose, from at least 1770 until the Patterson family ceased their traditional spade making business in 1990.

It will be seen that the origin, development and decline of the row of cottages at Patterson’s Spade Mill was inextricably linked to the development and changes that the various mills on these premises had undergone from sometime after 1770 to the second half of the twentieth century.

This report seeks to explore the events and nature of the changes that had taken place from that period in mid – 18th century to the present.

## 2. Credits and Acknowledgements

The survey was led by Harry Welsh and other members of the survey team were the late William Dunlop, Ian Gillespie, Anne MacDermott, Ken Pullin, George Rutherford, Ruth Thompson, June Welsh, Yvonne Griffiths and Michael Catney. The Ulster Archaeological Society is particularly grateful to Mr Malachy Conway, Archaeologist of the National Trust (NT) and to Patterson's Spade Mill Manager and Spade Maker Colin Dawson and his colleague spade maker Tom Mahon, who worked closely with the survey team in facilitating access and were in attendance during the survey to give a demonstration of Spade Making from iron ingot to a perfectly finished spade. In writing this report I called upon the wealth of knowledge that these two gentlemen had about spade making in general and details and history of the Spade Mill site over a long period of time. Appreciation is also extended to Ken Pullin and Leo Cunningham who afforded me the opportunity to see the National Trust Castle Ward Corn Mill and Waterwheel in operation as did Beth Black and her team of Tour Guides when I visited the National Trust Wellbrook Beetling Mill at Cookstown, Co. Tyrone to see the Beetling Engine and Waterwheel being operated. The staff at Queen's University Belfast McClay Library, the Belfast Ulster and Irish Studies Library in Belfast, the Linen Hall Library, Belfast and the Public Records Office of Northern Ireland were all most helpful in sourcing books, maps and documents and their assistance throughout was very much appreciated.

## 3. Introduction

### 3.1 Objective

In order to enhance the archaeological record of this site the Ulster Archaeological Society (UAS) carried out a survey the aims of which were to produce accurate plan and section drawings of the monument and carry out a photographic survey. This report will be submitted to the Northern Ireland Environment Agency and the National Trust. The report will also be added to the archives held by the Ulster Archaeological Society.



Fig 1 Survey in progress at Patterson's Spade Mill cottages, August 2010. (DSC6601)

### 3.2 Location

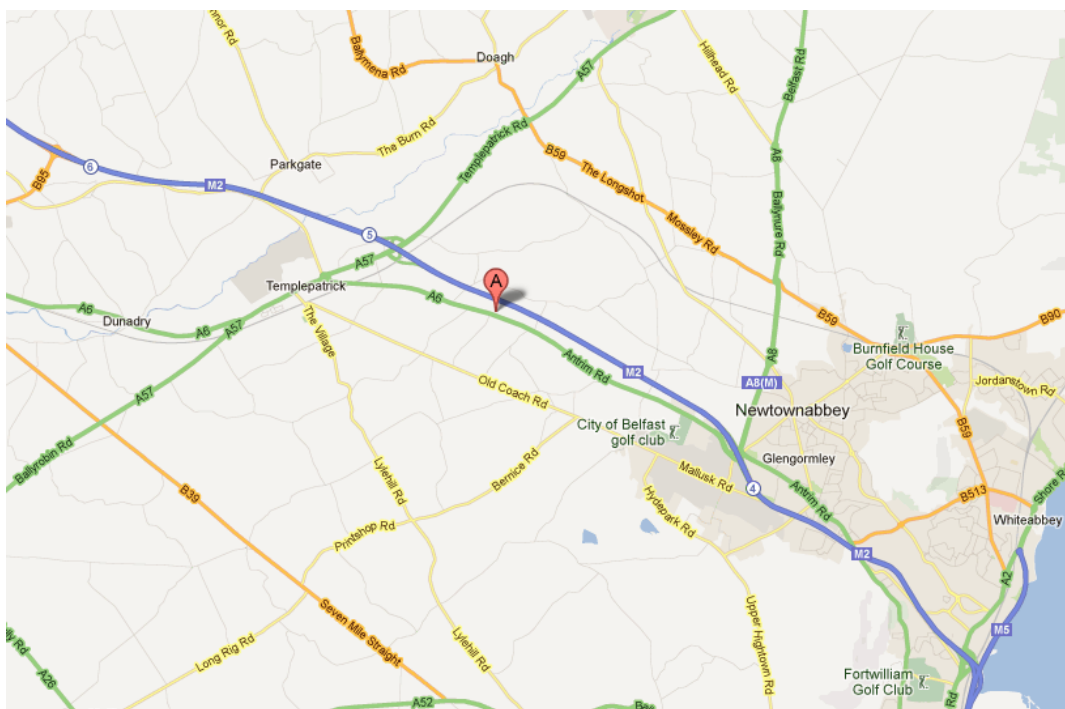

*Google Map™ at BT39 0AP*

Fig 2 location of Patterson's Spade Mill, Co. Antrim, BT39 0AP

The National Trust Patterson's Traditional Spade Mill is accessed down a short lane to a car park off the Belfast to Antrim A6 road at 751 Antrim Road, Templepatrick, County Antrim BT39 0AP, United Kingdom .

Geographic Location:- 10 digit Grid Ref = J 26177 85485

Within the National Trust Sites and Monuments Record (NTSMR) system five separate numbers have been allocated to this mill site. These are, the former Beetling mill (NTSMR 131001), the Spade mill workshop (NTSMR 131002), the head-race and tail-race (NTSMR 131004), the house adjacent to the tail-race (NTSMR 131005) and a row of former worker's cottages (NT130998).

### 3.3 Background

The survey was carried out by members of the Ulster Archaeological Society in response to a decision taken by the committee of the society to extend an opportunity to members to participate in practical surveys of archaeological monuments that had not previously been recorded. This followed a bequest to the society from the late Dr Ann Hamlin, from which the items of survey equipment were purchased. During discussions with Mr Malachy Conway, Survey Archaeologist of the National Trust in Northern Ireland, it was noted that many



archaeological sites on National Trust property had not been subject to a detailed archaeological survey and this site, amongst others, was identified as being worthy of investigation.

In 1992 the National Trust completed the acquisition of Patterson's Spade Mill. For the previous 72 years the mill was owned by the Patterson family of Spade Makers. This site has had a long history of milling such as Flax and Corn Mills, a Paper Mill, a Beetling Mill and has been a Traditional Spade Mill since 1920 until now.

### 3.4 Previous archaeological surveys.

When the National Trust acquired the Patterson's Spade Mill they commissioned Fred Hammond, an Industrial Archaeologist, to carry out a Preliminary Appraisal of the mill with a primary consideration being the conservation of the machinery at the mill. Fred Hammond issued his report in February 1992.

Sometime later the National Trust engaged Archaeological Development Services Limited to conduct a survey of the entire site. On completion of this survey a report entitled, *Archaeological and Historic Landscape Survey, Patterson's Spade Mill, County Antrim, Volume 1*, was issued in February 2009.

### 3.5 Cartographic evidence

For the purposes of this report the cartographic evidence taken consists of a James Crow map produced for Lord Donegall in 1767 -70 (PRONI, D835/1), and four Ordnance Surveys maps of Ireland relating specifically to County Antrim which are the 1<sup>st</sup> Ordnance Survey(OS) 6" County Map dated 1831- 1832 (OS-6-1-51-1), the 2<sup>nd</sup> Edition OS Survey 6" County Map 1857 (OS-6-1-51-2), the 3<sup>rd</sup> Edition OS Survey 6" County Map 1901 (OS-6-1-51-3) and 4<sup>th</sup> Edition OS Survey 6" County Map 1921 (OS-6-1-51-4) and 1977 OS 11inch map (OS-11-113-2-2).

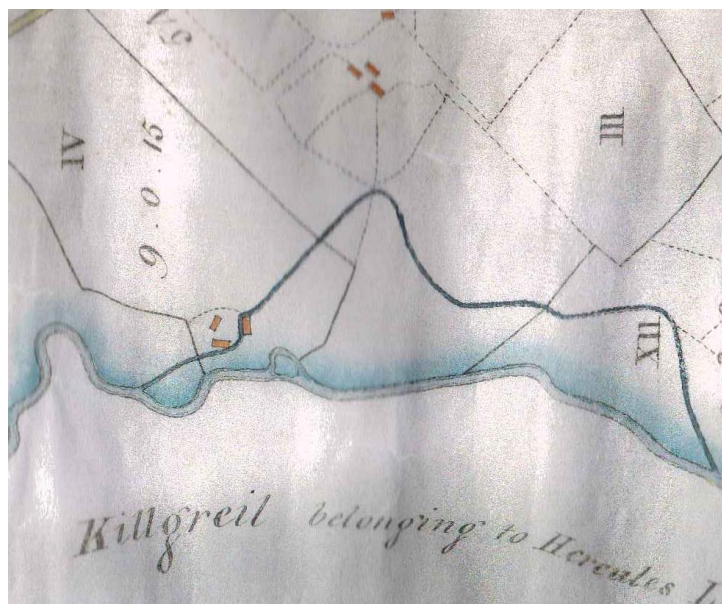

Fig 3. section of James Crow map 1767 – 1770:  
Ballyrobert and Carnanee Td. (PRONI, D835/1)



4a. 1<sup>st</sup> Survey OS-6-1-51-1(1831-32)  
(Surveyed 1832; Engraved 1833)



4b. 2nd Edition OS-6-1-51-2(1857)  
(1832 Survey Map - revised 1857)

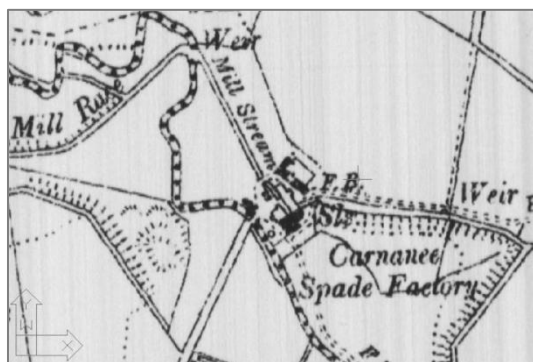

4c. 3<sup>rd</sup> Edition OS-6-1-51-3 (1901)

4d. 4<sup>th</sup> Edition OS-6-1-51-4(1921)

Fig 4. Ordnance Survey 6 inch Co. Antrim map tile 51 series – 1831 to 1921

### 3.6 Archiving

Copies of this report have been deposited with the Northern Ireland Environment Agency and the National Trust. All site records are temporarily archived with the Honorary Archivist of the Ulster Archaeological Society (UAS).

## 1. Survey

### 4.1 Methodology

It was decided that the survey would take the form of the production of plan and profile drawings and these to be complemented by a photographic survey. Use would also be made of the extensive detail drawings which were made as part of an assessment by the National Trust on how the Spade Mill complex might be enhanced to display the assets of the site to the best advantage.

### 4.2 Production of plan and profile drawings

Plan and profile drawings were completed from data obtained from a field survey. Measurements were obtained by using the society's *Leica Sprinter 100* electronic measuring device. Additional tape off-set measurements were carried out as necessary. Sketch plans at 1:200 scale were completed on site by recording these measurements on drafting film secured to a plane table and backing up the data on a field notebook for subsequent reference. Field plans were later transferred to a computer-based format for printing

### 4.3 Photographic archive

A photographic record of the site was taken by using a *Nikon - Coolpix S1*, 5.1 megapixel digital camera and a photograph record sheet was employed, corresponding to photographs taken during the site survey on 22 August and 29 September 2010 (Appendix 3). The archive has been compiled in jpeg format and saved to a UAS portable hard drive.

## 5. Discussion

### 5.1. 18th Century Milling at Patterson's Spade Mill.

In fig 2 above the James Crow map 1767 to 1770 shows a Head-race, with a distinctive sharp directional bend taken from the Ballymartin Water River and a Tail-race leading back to the Ballmartin Water river in Carnanee Td at the site which is now known as Patterson's Spade. The Head-race is shown to pass close to what would be the North wall of a building which is likely to have been a Water Powered Mill. The Tail-race is shown to pass the south-west corner of a second building before discharging into the Ballymartin Water River. This latter building may have been for mill worker's accommodation with an attached storage unit. The third building in the Crow map may have been the Mill Owner or Manager's house. The Head-race is still in use today to power the Patterson's Spade Mill Leffel Turbine. The Head-race distinct directional bend was altered when the M2 motorway section, between Sandyknowes and Templepatrick, was built some two hundred years later in c1974 - 75.

### 5.2 Flax and Corn Mills – 1767 to 1837

The first Ordnance Survey of Ireland was undertaken between the years 1824 to 1846 with the County Antrim area relating to Carnanee having been surveyed in 1832. A section of the resultant map of Carnanee Td relating to Patterson's Spade Mill location is shown in fig 3 above. It can be seen in the 1832 OS map that five buildings had been identified in close proximity to the Head-race and Tail-race. The Tail-race in this map is much the same as that shown in the earlier Crow map in that it leaves the North wall of what, as stated earlier, thought to have been a mill and proceeds to pass the south-west corner of a second building before discharging into Ballymartin Water River at the same point as that shown in the 1767-1770 Crow map. It can also be seen that the Head-race has been extended from that shown in the earlier Crow map and has been directed towards a second building for the purpose of powering a second mill which the records show was operational when a Valuation Survey was carried out on 28<sup>th</sup> January 1836

At the same time as the first Ordnance Survey of Ireland, 1824 to 1846, and as part of the introduction of a revised rating system, the First Valuation of Ireland Act was introduced by parliament in 1826 following which a Valuation of the whole of Ireland on a Townland by Townland basis was carried out between the years 1828 and 1840. The Townland Valuation of 1828-40 was primarily a valuation of land but included a valuation of certain houses, initially houses with an annual value of £3 or more (PRONI, VAL/1B). The Townland Valuation of Carnanee Td was carried out on 28th January 1836.

An indication of the number and dimensions of the buildings used for both the Flax and Corn mills identified at this location can be seen in the Valuator's Return for the 1836 Townland Survey of Carnanee as shown in Table 1.



The small pond would have provided a reserve of water to dampen the effect of fluctuations in head-race flow which would otherwise have had an effect on the instantaneous speed of the waterwheels. It is possible that the water was brought to what is thought to have been the corn mill waterwheel via an elevated flume that passed through the upper story of the building to be applied to a 10ft x 4ft located at the west wall of the mill as shown in fig 5. If that was the case, then it is likely that the current spade mill flume would closely represent what was in place when the corn mill was in operation

As well as giving the dimensions of the buildings the return also gave an assessment of the water power valuation on 28 January 1836 for the flax and corn mill is shown written vertically in table 1. It can be seen that the corn mill had 1 pair of mill-stones which were valued at £3-0s-0d per annum and that the flax mill was valued on the basis of having 5 flax scutching stocks valued at £2-10s-0d per annum. This valuation procedure was laid down in a set of strict guidelines in keeping with a the law to be applied.

A book of entitled *INSTRUCTIONS TO THE VALUATORS, APPOINTED UNDER THE 6th & 7th William IV CAP 84, for the UNIFORM VALUATION OF LAND AND TENEMENTS in IRELAND, Dublin 1839* (PRONI, VAL/13/2) was issued in order to provide uniformity and guidance to the Valuators in the Valuation process. This gave very detailed instructions and where necessary examples of how valuations were to be made concerning Land, Houses and Manufactories and included methods to be used in determining the Waterpower required in various types of mills. An example of the waterpower calculations given is shown in Appendix 1.

Written vertically at the side of Table 1 is the Valuators rateable value of the Waterpower taken separately by the corn mill and flax mill in January 1836. In the valuation, the mills were each assessed on the basis that they each worked for 12 hours per day and for only 4 months each in a year. It can also be seen that the quality of the flax mill was reduced from a B class to a C class mill meaning that it was “*Old, but in repair*” (PRONI, VAL/1/13, p46). The flax mill was also considered to have 5 flax mill stocks rather than 4. In the Instructions to Valuators mentioned above, a corn mill with a Class ‘B’ age rating with one pair of millstones was considered to require 6 horsepower to run and that 6 flax mill stocks would also require the same power as an corn mill with 1 pair of mill stones i.e., 6 horsepower or 1hp per Stock. Rating values for a Class ‘B’ corn mill with 1 pair of millstones was £9 per annum, hence, if the mill was only working for 4 months of the year the annual rate would be assessed as shown in Table 1, namely £3-0-0 or 60 shillings. When valuing the flax mill the Valuator simply took the value of the flax mill to be 5 sixths of the value of the corn mill, that is to say 5 horsepower, with a value of 50 shillings or £2-10-0. He seems not to have taken into account the lower rating of the flax mill which he had reduced to an older ‘C’ class mill. The rating for a ‘C’ class flax mill for 1 stock per annum would have been £1-6-0 and for 5 Stocks £6-10-0 consequently for only 4 months working the annual rate should have been £2-3-4

However, since he had to act on a set of Legal Instructions he had to justify his decision. He would not have acted as the sole arbiter since he would have had to have the agreement of two Assistant Valuators and he would have been required to read out aloud to them the *Settled Value* and the reasons for the decision before signing it off.

Nevertheless, what he is in fact indicating is that the corn mill needed 6 Horse Power (hp.) to operate and the flax mill needed 5hp.

To carry out the calculations it is necessary to know the fall of water which is applied to a particular waterwheel. The Instructions to the Valuators defined the fall of water essentially to be the vertical drop taken from the water level in the flume to the lower extremity of the waterwheel. The Valuators at Carnanee appear to have used a mean value of the level of the mill pond to be the upper level with the lower periphery of the waterwheel as the lower limit.

Using the waterpower calculation method given in the Valuator's Instructions then it can be shown that a 14ft x 4ft breast waterwheel with a fall of water of 12ft and turning at 6.6rpm would product an output of 5.9hp sufficient to meet the Valuators assessment of 5hp for the flax mill. Using the same method, a 10ft x 4ft breast waterwheel with a fall of water of 18ft and turning at 6.6rpm would produce an output of 6.1hp which would meet the Valuators assessment of 6hp for the corn mill. The position of the corn mill wheel gave it the applied 18ft Fall of water

From this it is assumed that the flax mill was driven by a 14ft x4ft waterwheel and the corn mill by a 10ft x 4ft waterwheel. As will be shown later the 14ft x 4ft wheel remained on site and was tested in a valuation survey in March 1862



Fig 6. View of South wall of the Corn Mill with arched window –  
- the flume is seen passing through the building. (GT –I1900, 1)

### 5.3 Paper Mill - 1837 to 1901

The Ordnance Survey Memoir for the Parish of Ballymartin, County Antrim by James Boyle dated 9 December 1838 referred to the Paper Mill in Carnanee in which he stated that the “*establishment was, until the year 1837, occupied as a corn and flax mill: it was then converted to its present purpose. It afforded employment to 19 persons viz. 11 males and 8 females*”.

The memoir also highlights the “*Beneifits of a New Road*” in the Parish of Ballymartin when it states that “*Among the most important modern causes of improvement was the construction in 1832 of the new line of turnpike road from Belfast to Antrim. Since that period, the face of this part of the country has undergone a total change, and a district which had previously been almost barren and uncultivated now bears a tolerable fertile aspect. The road leads to the important seaport and market of Belfast which is 8 and a half miles from the nearest point of the parish*” (Day, Williams, 1990, 6.)

Belfast was at that time experiencing a steady rise in population from 19,000 in 1801 to 70,447 in 1841 (Bardon, 1995, 66) with increasing industrial activity which continued throughout the remainder of the 19<sup>th</sup> century. It would seem that this would have been a suitable environment for the new proprietor Mr Robert Sloan to launch a Paper Making business with a steady market for the produce and just as importantly a good supply of the basic raw material required to make the paper, namely, Rags. Not all rags were of course suitable with Fairbairn (Part 2, 1865, 242) describing the suitability of the various forms of rags which may be useful in paper making and those which would not be of first choice but there would nevertheless likely have been sufficient material within reach to save him from going much further afield and therefore keeping his cost within reason.

So it was that sometime between 28 January 1836, when the Valuation Survey for the flax and corn mills (table 1) was carried out and sometime in 1837 when flax and corn milling at this location was abandoned that Robert Sloan installed a Paper Mill. An indication of the changes that was made to accommodate the paper mill installation can be seen by comparing the 1<sup>st</sup> OS map (1832-33) and the 2<sup>nd</sup> OS map (1857) as shown respectively in figures 4a and 4b above. These changes are represented in more detail in Fig 7 below.

The outline dimensions of the buildings are based largely on measurements given in the Griffith Valuation Return of 25 March 1862 (PRONI, Val/2/B/1/11)). A copy of the relevant page is shown in Appendix 2.

Considering the changes required, then fig 7 shows that the former corn kiln and kiln store house were demolished and the corn mill two story building was extended to form the paper mill two story Rag Store and Engine Room. The new paper mill single story Machine Room was abutted against the south-west wall of what was the corn mill.

A further significant change was in the diversion of the Tail-race waterway which was redirected from the previous discharge point on the Ballymartin Water river to a discharge point further down stream. This would have been necessary to cater for the installation of a new 25ft x 6ft waterwheel sited between the two story rag store/engine room and Workshop/Cart House building in order gain the necessary fall in the tail-race since the 25ft diameter wheel would have required the tail-race pit to be sunk much deeper than the original corn mill pit. The former head-race also underwent a considerable change. The small pond shown in the 1832-36 configuration (fig 5) was elongated to form a much larger pond some 200 metres long and 8 metres wide on average in the head-race as can be seen in fig 7. This would have been necessary to ensure, as far as possible, that the 25ft waterwheel had a sufficient supply of water to run at a reasonably constant speed since fluctuations in speed of this main drive could have adversely affected the quality of paper produced.

To accommodate the installation of the new tail-race it was necessary to take down the Mill Managers House. This house was replaced by the house labelled 1 in fig. 7.

It can also be seen that the north-west unit in the row of cottages was extended and that the flax store labelled 2 in fig 7 was also taken down and a cottage erected on north-east side of the row of cottages. An additional unit was also added close to the south wall of the flax mill.

It is clear that a considerable amount of restructuring had taken place from 28 January 1836 up until the commissioning of the paper mill which the memoirs say was operating in 1837.

The paper mill rag store/engine room later became a Beetling Mill the ruins of which remain today with the present spade mill flume in the same place as shown in fig 7.

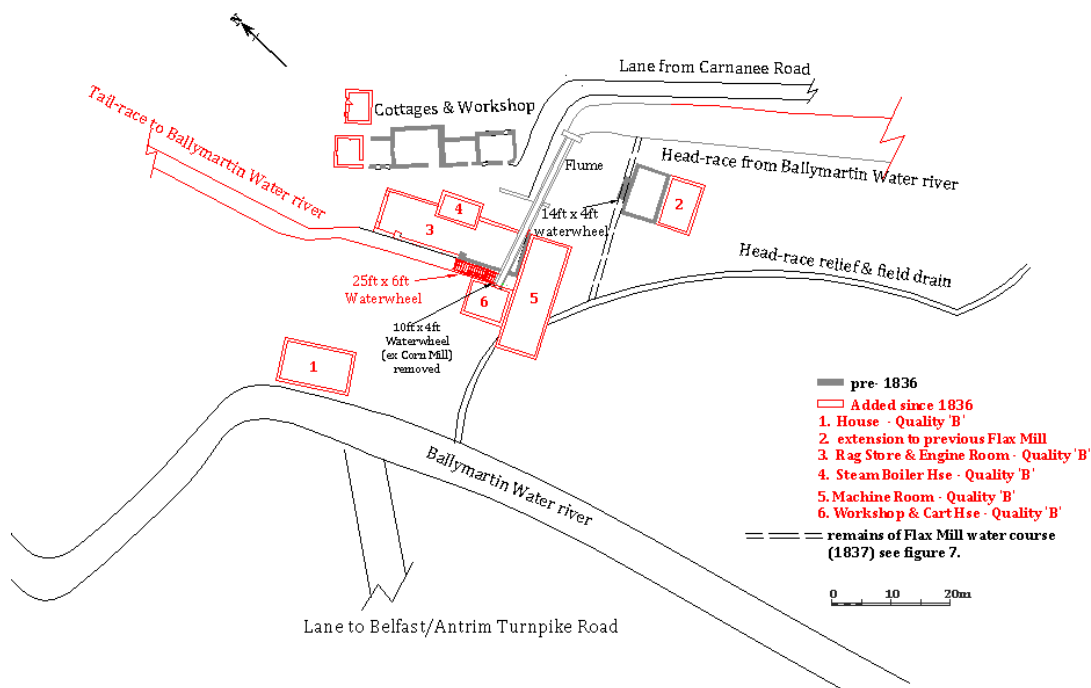

Fig 7. Paper Mill installation – changes in line with 1862 Valuation Return

Regarding the size of the waterwheel involved in running the paper mill then this information is first referred to in the 1838 Ordnance Survey Memoir for Co. Antrim Parish of Ballymartin .

In the 1838 Ordnance Survey Memoir two waterwheels are mentioned as being a 25ft diameter, 6ft broad with a 25ft fall and a 14ft diameter, 1ft 4 inches with a fall 18ft to power the Paper Mill established in 1837 by Robert Sloan. However, in the later 1862 Griffith Primary Valuation Field Book (Appendix 2) for the paper mill in this part of Carnanee Td three waterwheels were recorded and described as being a 25ft diameter wheel, 6ft broad, a 14ft diameter wheel, 4ft broad, fall not given (noted as being “not in use”) and a 10ft diameter wheel, 4ft broad, fall not given. It would be reasonable to assume that the 25ft wheel was the same wheel that was in place in both 1838 and 1862. In the 1862 Valuation the Horsepower (hp) rating for the paper mill was “in full, about 22hp, 10hrs for 9 months”.

The Valuator concluded that the mill only needed the power output from the 25ft x 6ft waterwheel. The most likely situation was that the 14ft wheel was in fact the 4ft broad wheel as given in the 1862 Griffith Valuation and not 1ft 4inches as given in the 1838 OS Memoir.



The 14ft x 4ft waterwheel would, as stated earlier, likely to have been used to provide the 5hp required by the flax mill. The 14ft wheel remained in position and was tested in the 1862 Griffith Primary Valuation process in relation to the paper mill as shown in Appendix 2.

Paper making in Carnanee seems to have reflected the industry trends during the 19<sup>th</sup> century in that, from the start of paper making by Robert Sloan in 1837 there was a 25 year period of stability with the only change being that the ownership seems to have passed from Robert to a William Sloan, presumably a son or close relative, sometime before the Primary Valuation of Ireland in 1862 with local paper manufacturing showing a steady decline during the second half of the 19<sup>th</sup> century (Oxford Companion to Irish History, 2011, 449).

A First Revision of the Primary Valuation was carried out in 1864 which recorded that the paper mill had changed hands from William Sloan to a company shown to be Diamond & Steen. The next Rates Revision (1867 – 1880) shows that efforts to maintain a viable paper making business in Carnanee continued when by 1877 the mill again changed hands with the new owners being the Carnanee Paper Mills Company. The record also indicates that Carnanee Paper Mills Company had at that time carried out improvements to the mill. In the Valuation period 1881 to 1891 the mill was held by the Ballyclare Paper Mills Company. However, by July of 1891 this company had removed the machinery and the buildings were recorded as being dilapidated.

Considering the Paper Mill process, William Fairbairn gave a brief description of the process involved in 19<sup>th</sup> century in making paper from rags (Fairbairn Part 2, 1865, 239-251). A representative schematic of this process is given in fig 8 below.

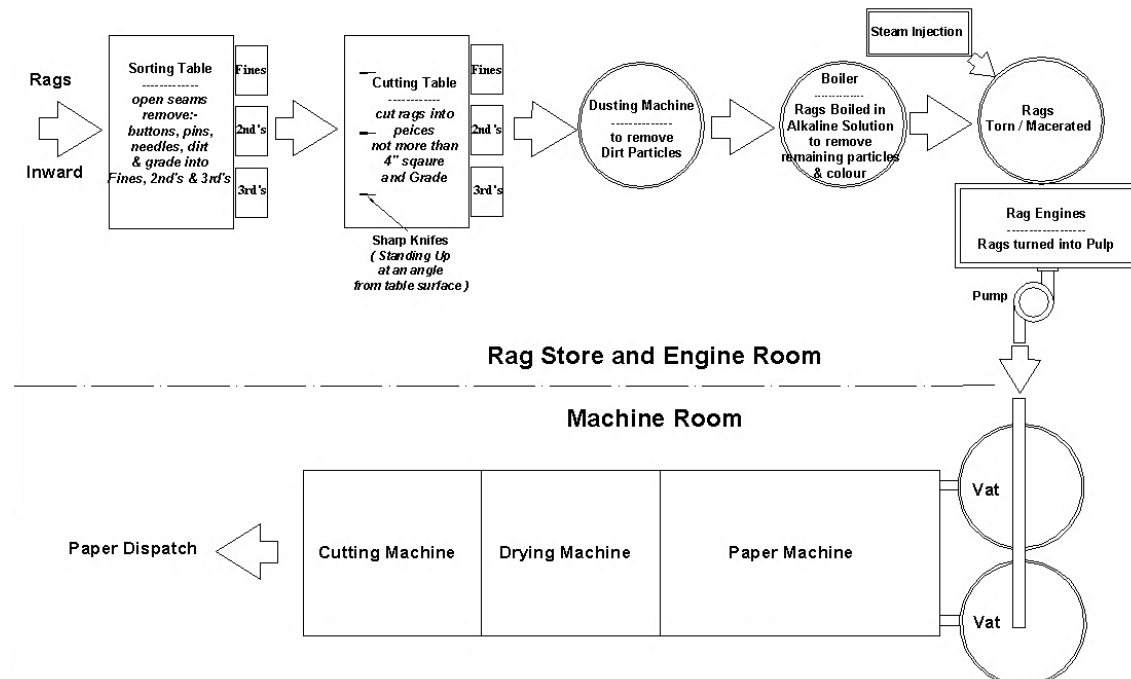

Fig 8. Schematic representation of 19<sup>th</sup> Century Paper Making process (based on Fairbairn, Part 2, 1865, 239-251)

By 1901, the property was taken over by Moorefield Dyeing and Finishing Company who, as the 1901 OS 3<sup>rd</sup> Edition Map (fig 4c) shows, had established a Beetling Mill on this site in Carnanee Td and was labelled on the Ordnance Survey map as the “*Carnanee Beetling Mill*”

Fig 9 represents the position as shown in the 1901 Ordnance Survey when the property was used as a Beetling Mill with four buildings having been added since 1862 and a Weir taken from the Head-race pond to discharge into a re-formed Head-race Relief & Field Drain system.

The Beetling Mill lasted until 1913 but a mill office and store was retained up until 1919 by the Moorefield Company shortly after which the premises changed hands to W. G Patterson & Sons who by 1920 had established the Spade Mill. The Ordnance Survey Maps labelled the Mill as the “*Carnanee Spade Mill*” from 1921 until 1954 then reference to the Spade Mill was omitted until the present map series with the mill now labelled - “*Patterson’s Spade Mill [NT]*”.

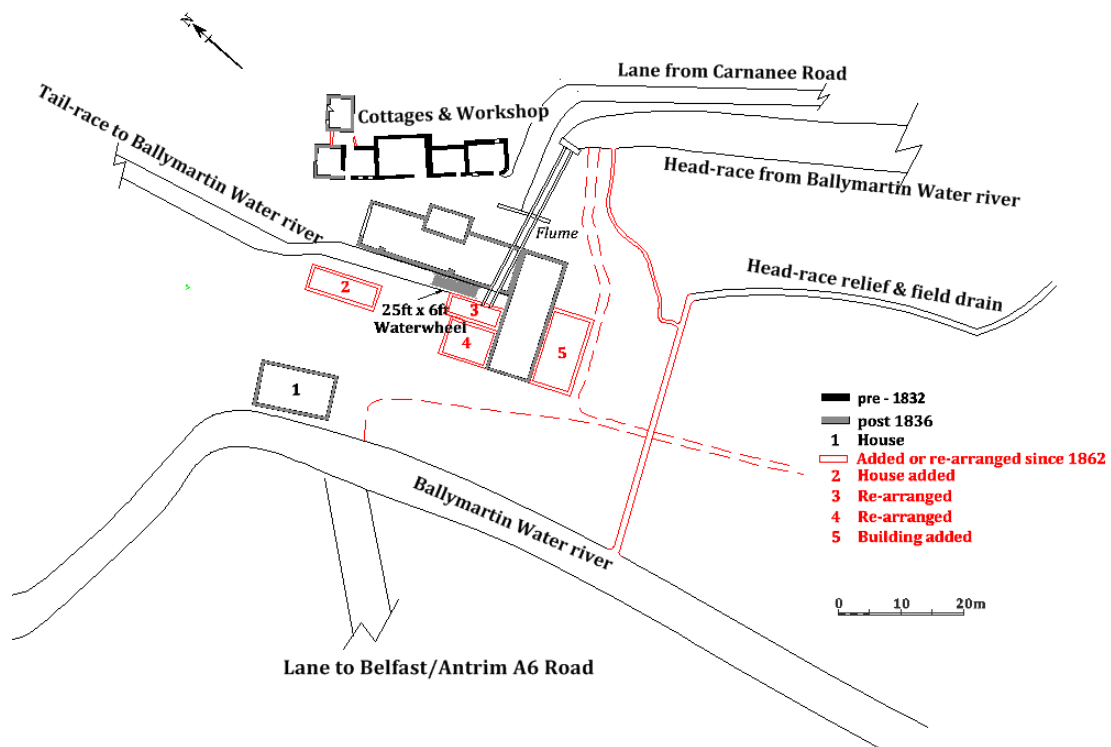

Fig 9. Representation of the Mill complex in accordance with the 1901 OS map.



Fig 10. Single story roofed Paper Mill Machine Room facing east with remains of south wall of Rag Store and Engine Room (GT-I1900, 2 )

#### 5.4 Spade Mill Buildings

Noticeably, the units associated with the Flax Mill in the 1836 drawing fig 5, had been removed entirely sometime between the 2<sup>nd</sup> Edition Ordnance Survey of 1857 since they were not included in the Griffith Primary Valuation of 1862. This is reflected in 3<sup>rd</sup> Edition of Ordnance Survey, 1901 (fig 4c).

The house marked Unit 2 in fig 9 which is shown close to the Paper Mill Tail-race was added sometime between 1862 and 1901. It is worth noting that it was built quite close to the position of the Mill Managers house shown in the 1836 layout of the flax and corn Mills (fig 5) which had to be removed by November 1836 to make way for the re-directed Tail-race during the construction of the paper mill. Unit 4, shown attached to what was the Paper Mill Machine Room, was also added during that period. This extension was later to become what is now the spade mill finishing shop. Units 2 and 3 are a revised arrangement of what was the Workshop and Cart House in the 1862 which was eventually developed into what is now the Reception and Exhibit area of the Spade Mill. Some or all of the building changes which took place between 1862 and 1901 may have been as a result of the improvements carried out by Carnanee Paper Mills Company after they took possession of the Paper Mill in 1887.

Fig 11 shows the layout of the property as it was at the time of the 4<sup>th</sup> Ordnance Survey in 1921.

It can also be seen that a pathway had been built from the mill sluice gate down to the yard on the south side of the mill. This pathway is in place today.

The essential changes to the buildings between the establishment of the Beetling Mill in 1901 and when the premises changed to a Spade Mill in 1920 was that the Paper Mill Rag Store and Engine Room building fell into disuse together with the two buildings in what was previously the Paper Mill Workshop and Cart House area in the 1862 Valuations. The blacksmiths shop or workshop in the centre of the row of cottages also fell into disuse between 1901 and 1921.

When the Spade Mill was established in 1920, the 25ft x 4ft Waterwheel which had been in place since 1836, was replaced by a 20 inch Leffel Double Turbine Waterwheel Turbine contained within a 54 inch diameter steel globe. This is the arrangement which powers the Spade Mill at present.

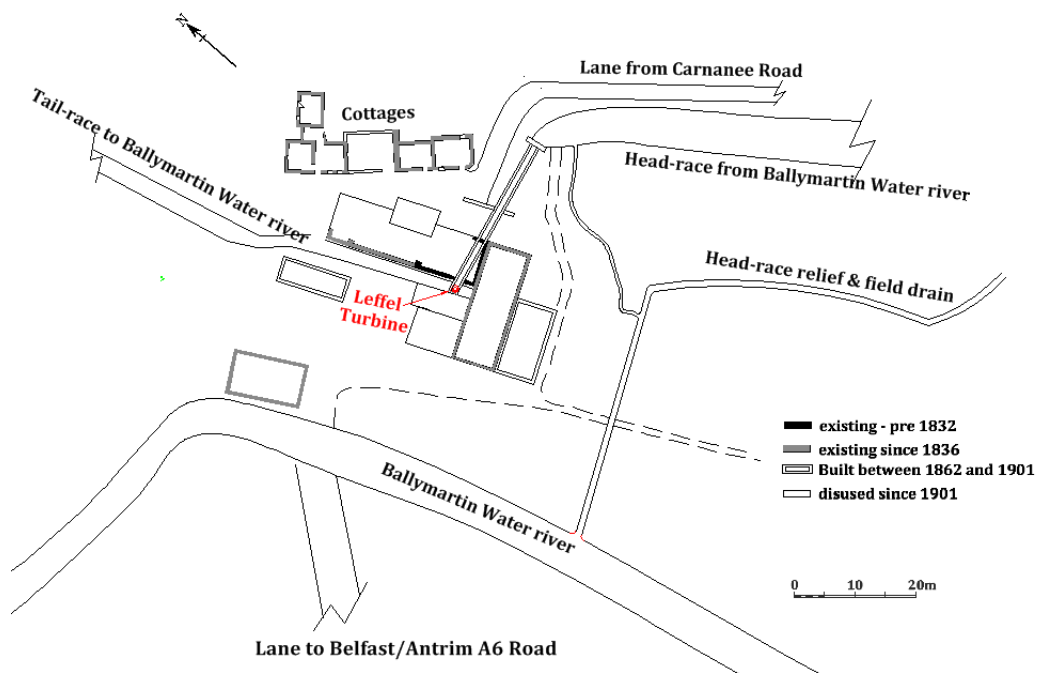

Fig 11. Spade Mill complex in accordance with the 1921 OS map

Other minor changes and rearrangements had taken place since 1921 which are represented in fig 12 showing the position as it was in 1977. The essential difference between 1977 view and the present time is that the Reception and Exhibit area have been developed into what exists today.

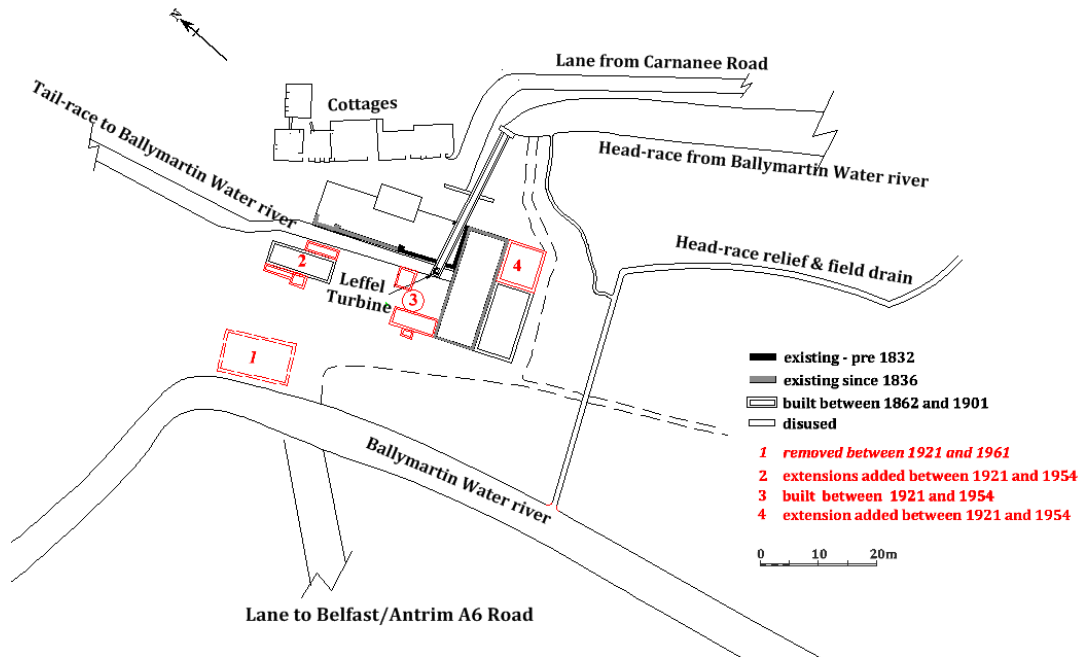

Fig 12. The Spade Mill complex up to 1977 (OS-11-113-2-2)

The main source of power for the operation of Patterson's Spade Mill is a James Leffel Double Turbine Water Wheel. This turbine powers the Tilt Hammer which is at the heart of the Spade Manufacturing process at the mill. It also powered through a series of belt drives other vital machines involved in the process.

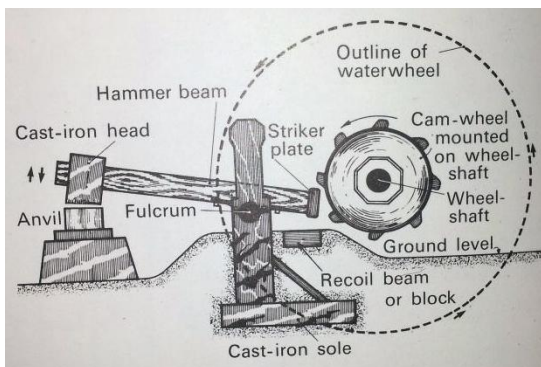

Fig 13. Tilt Hammer (after McCutcheon, p 258)



Fig 14. Tilt Hammer in operation at Patterson's Spade Mill (DSC6653)

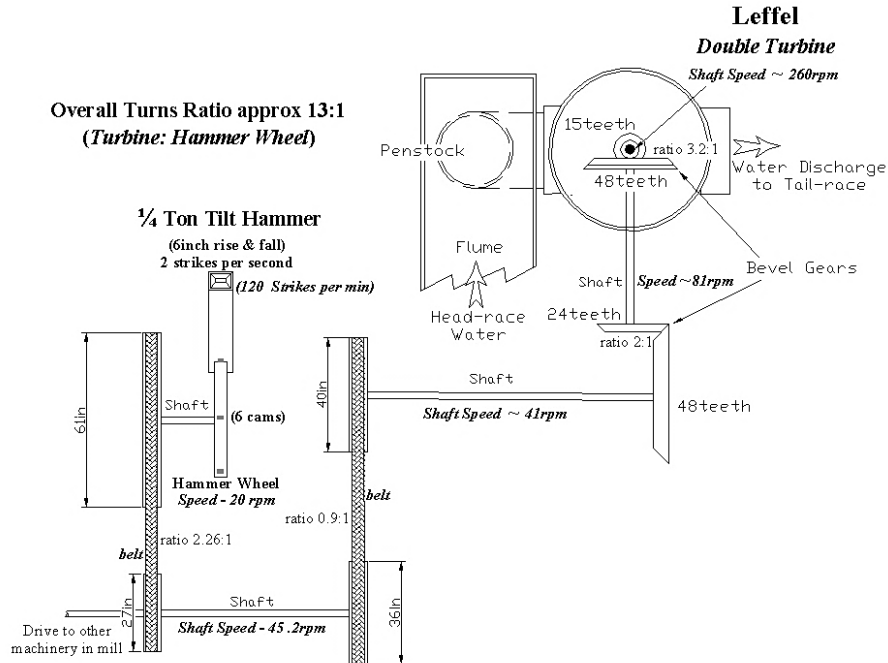

Fig 15. Patterson's Spade Mill Tilt Hammer Drive schematic.

The Tilt Hammer operation was timed and seen to operate at 2 stokes per second or 120 stokes per minute. By counting the teeth on the bevelled gears and drive belt wheel diameters an average speed of 260 rpm was recorded for the Leffel Double Turbine Water Wheel drive shaft.

Neglecting losses, the 1/4 Ton Tilt Hammer with an attached striker piece of 20lbs expends slightly over 1hp and requires a vein of water of approximately 290 gallons(UK) or 1.3 ton per minute passing through the sluice gate to drop 25ft onto the Leffel turbine to raise the hammer head and striker piece (top fuller) the required 6inches for striking every half second. All other loading would require an additional quantity of water through the sluice gate.

The traditional Spade Making process as carried out at Patterson's Spade Mill since it began in 1920 is represented in the following simplified materials flow diagram:-

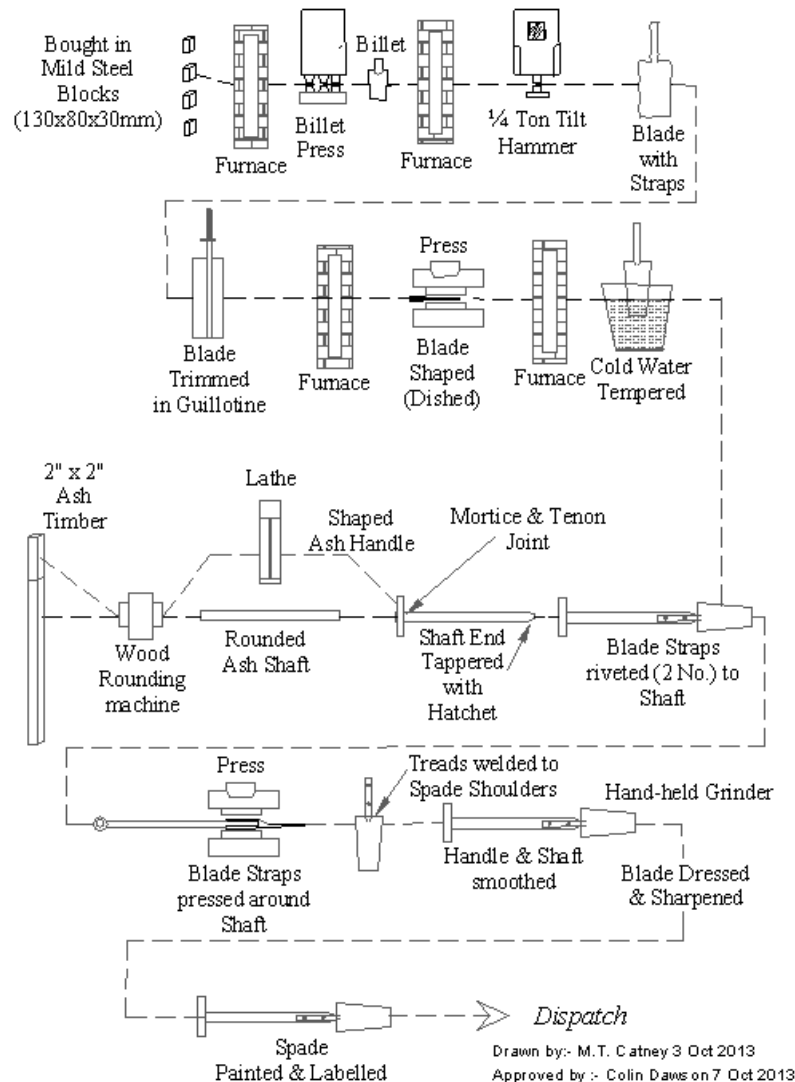

Fig 16. Patterson's Spade Mill manufacturing process simplified Flow Diagram

The James Leffel Double Turbine Waterwheel which powers the present Spade Mill is an intriguing piece of machinery the history of which is perhaps worth examining with what could be considered to have a theoretical connection with Belfast.

### 5.5 Leffel Double Turbine Water Wheel.

Until the introduction of water power, man had for millennia relied on the power of muscle either his own or those of domesticated animals for nearly all enterprises both large and small. The labour-saving potential of the water wheel was considerable. For example, even a small two to three horsepower vertical water wheel could free as many as 30 to 60 men or, more likely, women from the tedious task of grinding grain. Among prime movers the vertical water wheel was long one of the most important. (Reynolds, 1983, 4)

Early Vertical and Horizontal water wheel wheels used flat paddle boards fixed around the circumference of the wheel whereby water flowing past the wheel acted on the paddles which were in contact with the water to cause the wheel to rotate. It became obvious that a considerable amount of the available energy was being lost due to excessive spillage over the side of the paddles and also that the weight of falling water was more useful than simply allowing the water to strike the wheel on passing to cause rotation. Sides known as *Shrouds* were fitted on both sides to create “*buckets*”. In the mid-1700’s John Smeaton, an English engineer, and others began to move away from wood as being the only material used to make the waterwheel to the use of a combination of wood and cast iron in the construction of the wheel. The heavy wooden flat buckets were replaced by much thinner shaped lighter metal buckets.

The traditional Vertical Water Wheel was characterised into four main types each determined by the method employed in applying the water to the wheel as follows:-

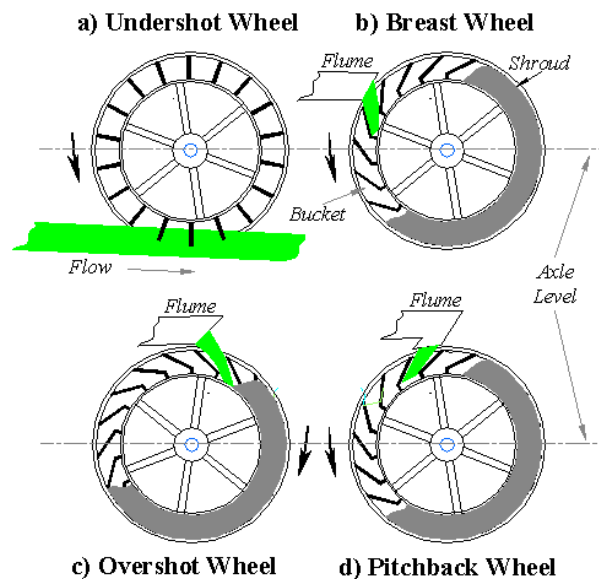

Fig 17. Traditional Vertical Water Wheels

The early Instructions to the Valuers between 1833 and 1854 simply gave a typical value of horsepower which a particular type mill might take in a day and the quality of the machinery being considered. This was to meet the requirement that only the power used was to have a rateable value. However, in the 1854 Instruction to the Valuers (PRONI, VAL/13/4, 63 – 64) a method of calculating the power taken by a waterwheel when the mill was operating was set down with a typical calculation included (Appendix 1).

The 1854 Instructions gave Efficiency (*Modulus*) values to be applied to the tradition vertical water wheels as follows:-

- |                   |     |                                |
|-------------------|-----|--------------------------------|
| a) Overshot Wheel | 75% |                                |
| b) Undershot      | 33% |                                |
| c) Breast Wheel   | 66% | Breast wheel with buckets      |
|                   | 55% | Breast wheel with float boards |

They also gave a range of 65% to 78% when valuing the power output of a Turbine.



To compensate for the fact that water is progressively lost from the buckets from full or near full to empty as each descends to the lower periphery of the wheel the Townland Valuation calculations averages this out by declaring that each bucket is only half full at any point in time. (PRONI, VAL/13/4, p64) thereby allowing each bucket which was in contact with the falling water to count in the calculation. The accepted norm up until the development of the water Turbine was that the most efficient water wheel was the Vertical Overshot wheel with a high end efficiency of 75%. By the middle of the 18<sup>th</sup> century work began to improve on the efficiency of the water wheel.

Developments in water wheel technology in the 18<sup>th</sup> century coincided with the *Industrial Revolution* which saw a rapid increase in mechanisation with an attendant increased demand for power.

At the beginning of the 19<sup>th</sup> century engineers turned their attention towards waterwheels that could have water applied not just at one point on the wheel as in the Traditional Vertical Water Wheel but that the water would be in contact with the entire wheel when it was falling from a high point to a lower level. This type of machine became known as the Water Turbine from the word “*turbine*” meaning “*Swirl*”. This period in time marked the beginning of the decline of the simple Vertical Waterwheel. Although still in use today in many parts of the world, the Vertical wheel was steadily overtaken in applications by the Water Turbine.

Early in the 19<sup>th</sup> century, people such as Claude Burdin, Jean Victor Poncelet, and Bernoit Fourneyron became known for their work in advancing the concept of the Water Turbine technology. Each made a particular contribution which set down ideas and principles to be drawn on by those who followed in the pursuit of obtaining the maximum power from this type of water wheel. Of particular interest in this discussion dealing water turbines and with the Leffel Double Turbine Water Wheel in particular were two engineers of the 19<sup>th</sup> century, namely, James Thomson and James Francis.

Born in 1806 in Botetourt County, Virginia, James Leffel was a baby when his parents, John and Catherine Leffel, moved to Ohio. The family settled near Donnel’s Creek, several miles west of the hamlet of Springfield, Ohio. Here the father erected a sawmill and a gristmill. From an early age Leffel worked in the mills learning general mill technology and developing particularly an interest in water wheels. In the 1820’s he built a saw mill in which he installed a wheel of his own design and construction. For the next forty or so years he relentlessly pursued an ambition to improve on the Overshot Vertical Water Wheel which was considered at the time to be the most efficient water wheel. In 1862 his years of labour bore fruit. Early in that year he was granted a patent for a reaction type turbine wheel. In the words of one authority at the time, This improved Leffel wheel was a double bucket design, namely, with a ring of upper buckets and a ring of lower buckets immediately below them and arranged so that the water would pass through both of these sets of buckets and on out into the draft tube in the most efficient manner, thereby creating the highest results in power and speed for the amount of water and the fall of water that were being utilized (Becker, 1966, 200-210).

The *Leffel Double Turbine Water Wheel* is a combination of two turbines which can be identified as a Vortex Wheel mounted on top of a Reaction type Wheel with a single separating plate.

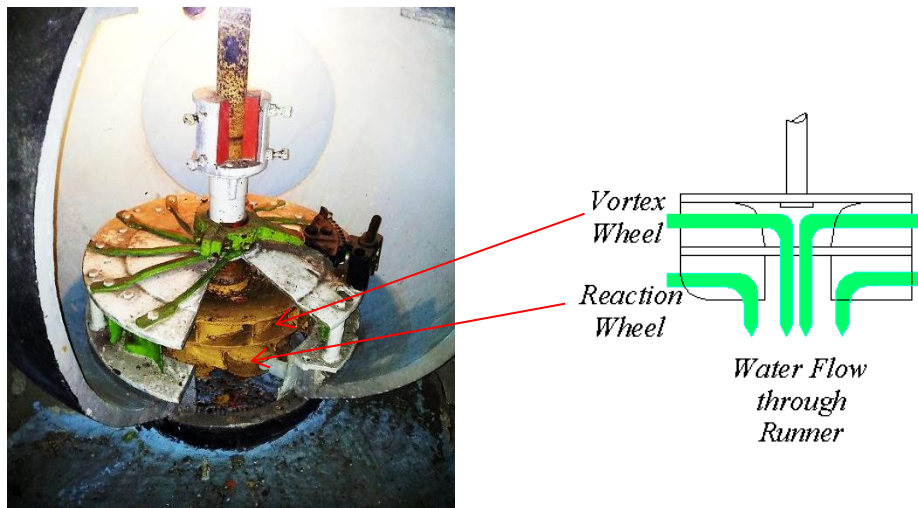
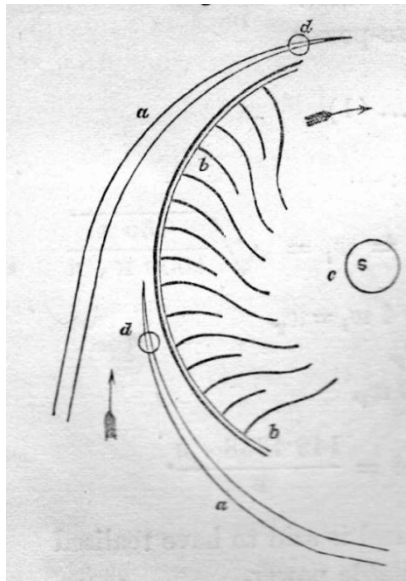

Fig.18. cut-away view of Patterson's Spade Mill Leffel Turbine  
(Patterson's Spade Mill exhibit)

The Vortex Water Wheel.

On 3 July 1850 James Thomson patented a horizontal water wheel which he named the 'Vortex Water-wheel (Patent No. 13156). As the name suggests, the principle of operation of the wheel is based on the Vortex Motion of water, as for example, when water exits through a circular orifice. This feature can be seen by floating a plastic flat topped cap of an aerosol canister (say 45mm diameter) over the waste of a half filled wash-hand basin when the water is allowed to drain from the basin. This simple circular motion was what James Thomson set about to control and guide in his Vortex Water Wheel.

Writing in 1865, William Fairbairn wrote under the heading "*Turbines in which the water flows horizontally inwards: vortex wheels*" Fairbairn states that "*We owe the invention of this class of turbines to one of my own pupils, Mr. James Thomson, C.E. of Belfast, and probably no turbines are more efficient or capable of more general application to every variety of fall than the vortex wheels he has constructed*" Fairbairn included a diagram showing the general form of the guides and passages of the vortex wheel fig 19 ( Fairbairn, Part 1, 1864,166).



*a-a: are fixed guides  
 b-b: passages of the wheel  
 c: opening passage of the wheel  
 s: vertical shaft carrying the wheel  
 and communicating its motion to the mill*

Fig. 19. James Thomson Vortex Turbine (after Fairbairn, Part 1, 1864,166)

James Thomson (1822-1892) was a Belfast born engineer and physicist whose reputation is substantial though it is overshadowed by that of his younger brother William Thomson (1824 – 1907) who became Lord Kelvin – 1<sup>st</sup> Baron Kelvin in recognition of his contribution to science in the 19<sup>th</sup> century. At the time of Fairbairn's publication, James Thomson was, by crown appointment, Professor of Civil Engineering at Queen's College, Belfast, now Queen's University Belfast.

The lower wheel in the Leffel Double Turbine can be described as a Francis type reaction turbine.

The Francis turbine is a type of water turbine that was developed by James B. Francis a British born American engineer in Lowell, Massachusetts in 1848. It is an inward-flow reaction turbine that combines radial and axial flow concepts.

In the Francis turbine, the water flows from the penstock into a spiral scroll case and is then channeled to the turbine runner using adjustable guide vanes or wicket gates which directs the flow of water through the system. On leaving the runner the water is then discharged downwards through a draft tube into the tail-race.

The theory involved in both the Thomson Vortex Wheel and the Francis Reaction Turbine when taken together can be used to explain the operation of the James Leffel Double Turbine Water wheel.

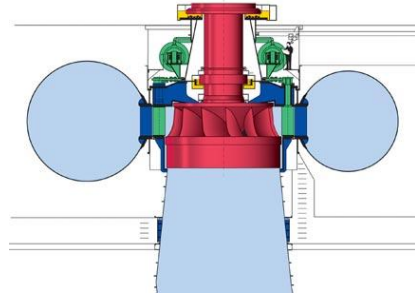

Fig. 20. Francis Turbine diagram (*Wikipedia: Francis Turbine*)

A striking advantage of the water turbine over the traditional water wheel can be seen by comparing the size of the Leffel Turbine with that of the 25ft water wheel it had replaced by 1920 as shown in fig 21.

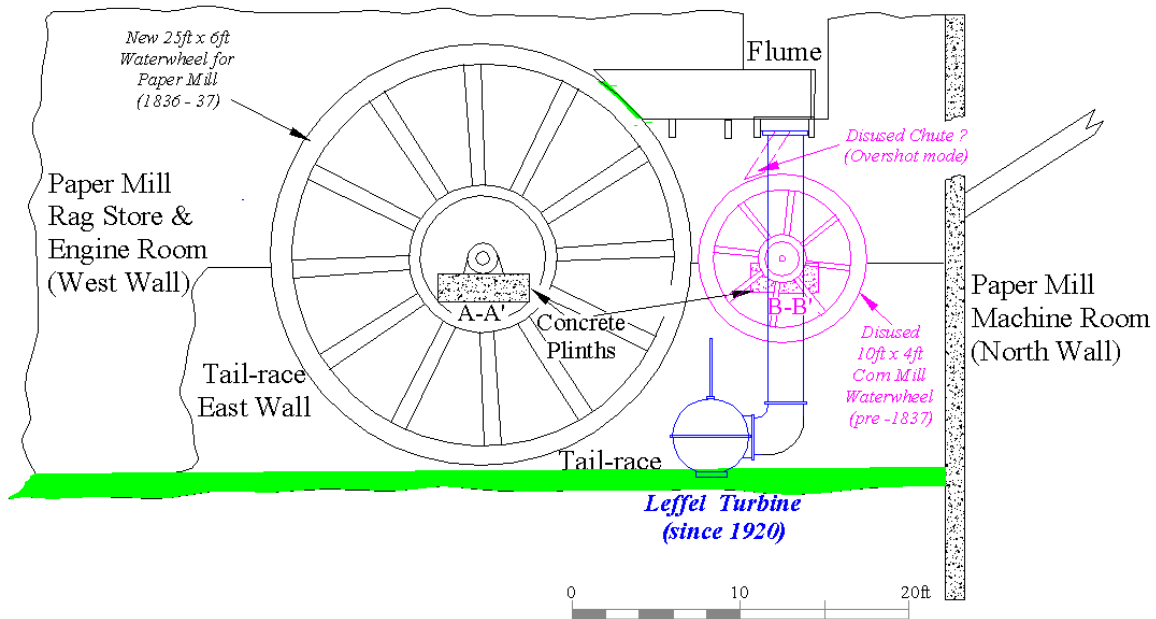

Fig 21. Possible arrangement of 25ft Waterwheel in 1837

The Leffel Turbine with a 20 inch wheel in a 54 inch diameter globe was, according to the Leffel Handbook of 1885, capable of producing a power output of 31.5hp with a Fall of 25ft and a water discharge of 752 cu ft per minute whereas as Appendix 1 shows the 25ft waterwheel required 1392 cu. ft per minute to be expended (almost twice the amount of water) with a fall of 25 ft to produce 21.8hp. Additionally, the Leffel Turbine is physically only a fraction of the size of the 25ft wheel.

James Leffel died in 1866. It is a fitting tribute to James Leffel that the company he established in 1862 has stood the test of time and is still in business today in Springfield, Ohio, USA, where the company manufactures Hydraulic Turbines.

## 5.6 The Patterson Spade Mill Cottages.



Fig. 22 Patterson's Spade Mill Cottages c1962 (*National Trust*)

The cottages, which are at present in ruin, originally consisted of a row of 4 units made up of three single storey houses 1 unit deep and a larger unit, unit 3 in fig. 23, likely to have been a workshop. As mentioned earlier these cottages were built sometime between the production of the Crow Map in 1770 and the 1<sup>st</sup> Ordnance Survey of this part of Co. Antrim in 1832. They would most likely have been built to accommodate an increase in the overall workforce when a second mill was built on the site between the years 1770 and 1832.

When, in 1836/37, the property changed hands and the previous Flax and Corn Mills ceased operation and were replaced by a Paper Mill, the property as a whole underwent considerable change in a short period of time. The effect on the cottages was that unit 5 was added as an extension made to unit 4 to make a larger house. This extended house would likely have been to provide an improved standard of accommodation for the new Paper Mill Manager in 1836/37.

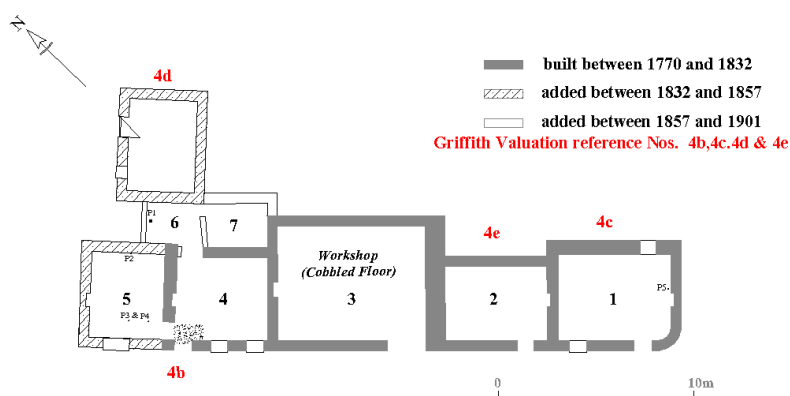

Fig. 23 Plan of Cottages – UAS survey 2010

A stand alone house – 4d in fig. 23 above, was also added during that period. This is the slated roof building which has been restored in recent years and shown in the background in fig. 24.,



Fig. 24. Ruins of cottages viewed from the south (DSC 6947)

#### Site Observations – Row of Cottages:

This is a range of buildings, mostly one room deep, lying north-west to – south-east and constructed of rubble (local basalt) and lime mortar. No roofing survives in-situ. The site slopes sharply to the west.

#### Bay 1:-

This is at the south-east or upper end of the row. Surviving walls stand 2½ to 6 feet high, but the south-west and south-east walls appear to have been substantially rebuilt in recent decades. The walls are about 2 feet thick on all sides. The south corner is curved, presumably to accommodate outside traffic.

The doorway is in the south-west wall at the south-east end. It is dressed with red brick, hand-made on south-east, and machine-made on north-west. Concrete has been used to form a jamb about 4 inches wide on the south-east side. The doorstep is a single block, probably rhyolite.

The bay has a clay floor hidden under loose material – ashes, clinker, broken concrete, broken brick, clay, and stone.

A window opening in the south-west wall about 2 feet from the north-west division seems to have been formerly 55cm. Above floor level and later blocked to a height 95cm. Above the floor. It is 3 feet wide.

In the north-east wall is another window 2½ feet from the south-east wall. It was 90cms. Above floor level, but a concrete block has been built-in to raise this to 110cms. The window is 98cm. Wide on the inside, narrowing to 78cm. The splay is in the original stonework. Concrete jambs have been added leaving a clearance, face to face, of 80cm.

The north-east wall is plastered on the inside from the south-east corner for a distance of 10 feet where it ends in a sharp line, which suggests a partition wall. The wall south-east of here has red bricks incorporated in its fabric at floor level and to a max. height of six courses.

In the SE wall, 5 feet from the north-east corner, is an area of red brick 75cm. High and 110cm. Wide – possibly representing a fireplace.

A cast-iron pipe about 13mm in diameter projects from the south-west wall at floor level a distance of 75cm ending in an expanded collar. It is bedded in mortar. A gap between two bricks allows egress on the outside of the wall.

The partition wall with Bay 2 is a rough construction apparently of National Trust period and nothing of it is worth mention.

#### Bay 2:-

The two long walls of Bays 1 and 2 appear to be built at one time. Bay 3 was added later.

No discernible windows or doors except for the entrance on the south-west wall close to the south-east end. Red brick is inserted on the inside and outside of the north-west side of the doorway at a low level. There is no brickwork on the south-east side. Immediately inside the doorway concrete flooring covers an area of about 8 square feet. Against the outside walls and next the north-west end of the room are mortared bricks: the north-western end of this room may have had a brick floor. In the north-east wall at waist height is a mural cupboard, 3 bricks high by the same wide. There are some very large boulders in the walls.

#### Bay 3:-

This bay is wider than Bays 1 and 2, stepped out at the north-east side. The wall is 21 – 24 inches thick. Cobbled floor throughout – irregular cobbles of local stone, typically 20cm. Long, but as much as 34cm. Two tiles are set into the floor, edge on, flush to the surface, 178cm. Apart. Between them the cobbles are larger and more roughly set. The rise known as a horse-stretcher is in the west of this room and a hollow is close to the north-east wall.

Along the north-west wall a strip 40 – 45cm. Wide is much disturbed, apparently dug out and filled with boulders (wall collapse?).

On the north-west wall is a niche edged with bricks and also backed by red brick on end. This niche is 76cm. Wide, 22cm. Deep on south-west side, and 38cm. Deep on north-east side. Above it is the gable of Bay 4, presumably built after Bay 3 became ruinous, because its roof line descends to an eaves height only 132cm. Above the floor level of Bay 3.

The entrance to Bay 3 abuts the outside corner of Bay 2 and is 198cm. Wide. The north-west side is 2½ (red) bricks wide. The threshold is 7 stones wide (rhyolite, basalt, basalt, rhyolite, basalt, basalt, rhyolite). The rhyolite block on the north-west side is neatly squared (14½ x 13 inches) and has two pivot holes 5 inches apart. At the opposite side the rhyolite block mirrors these features but also has an iron peg, which lies between the pivot holes and projects horizontally from the wall. Above this block are two courses of red brick, then a rhyolite quoin, two rough basalt stones (stretcher and header), rough rhyolite stone, more basalt.

On the south-west outside wall at the north-west end and at ground level is a gap between boulders which may have been a drain. This is about 50cm. Below floor level.

#### Bay 4:-

Butted onto Bay 3. There is a wall of red brick against the stone wall of Bay 3. It is only one brick (11cm.) thick and survives to five courses, cement-plastered within. This wall appears to have been built to screen the foundation (and sub-foundation clay) of Bay 3, but would afford inadequate defence for the occupant in the event of structural collapse. The bricks are 23 x 11 x 7 cms. And perforated by 20 holes in 3 rows. The other three walls are of basalt rubble bound with clay and faced with cement plaster on the inside, except in the vicinity of the fire where it may have been simply whitewashed. The front wall is about 22cm. Thick and is pierced by two

windows and a doorway. The windows have sills of brick, quarry tile, and cement. The door sill is cement, on top of a course of brick headers (on edge).

The floor is concrete except at the north where quarry tiles are laid flush with the concrete. All the quarry tiles are one foot square: indigo on the surface and speckled apricot within. Brickwork in the north-west wall suggests a fireplace at the middle of this wall where there is a hearthstone of red sandstone. To the south-west of this is a suspected site of a jamb wall facing the doorway. Here there is an exposure of red brown clay, overlaid with a grey layer, overlaid with the cement on which the quarry tiles were laid. Between the jamb wall and the doorway is a square concreted area stepped 5½ inches below the general level of the floor.

In the north-east wall near the north-west end a brick-lined doorway leads to Bay 6. Close to this is another window opening to the yard (Bay 7). Its sill is also of brick overlain with cement, but at a higher level than the front windows.

Immediately inside the front door of Bay 4 a doorway on the left steps down to Bay 5.

#### Bay 5:-

This has been butted against Bay 4. The height of the walls vary from 0.3 to 2.5m. All the walls are of basalt rubble bound with clay, possibly skimmed with lime mortar and whitewash, but the general size of stone seems smaller than other bays, especially on the inside.

There is only one entrance, that from Bay 4. But there appears to have been a doorway to the outside, now blocked, on the south-west wall, 35 inches wide from the outside corner of Bay 4. A window in the south-west wall is lined with brick, apparently 39 inches wide.

A fireplace in the north-west wall has red brickwork on either side, and a single skin of stonework on the outside. The floor is concrete except for eight quarry tiles at the fireplace. A piece of cast-iron fireplace surround (30 x 12 inches: 310 x 65cm.) is lying in this room.

A window in the north-east wall is lined with brick on the north-west side. The width is indeterminate, but possibly the same dimensions as the window in the opposite wall. The remains of iron tubing set into the floor indicate an animal pen.

#### Bay 6:-

This is entered through the back door of Bay 4 and was formed by building two red brick walls (Flemish bond, one brick thick) between Bay 4/ Bay 5 and an outbuilding. The north-west wall is perpendicular to both Bay 5 and the gable wall of the outbuilding. It reaches its maximum height of 1.60 m. at its juncture with the outbuilding. The other wall angles between the corner of the said gable wall and the edge of the doorway from Bay 4. It reaches a maximum height of 7 feet (2.10m.) above floor level. These are hand-made bricks 9 x 4½ x 3 inches (22 x 11 x 7.5cm.)

There is a window in the north-west wall, 31 inches wide on the sill (quarry tiles) and 24 inches wide between the uprights of the (now missing) wooden frame. The window sill is 90cm above the floor.

The floor is on the same level as Bay 4 and is quarry tile throughout. A cast-iron pipe, with an external diameter of 148mm rises from the floor directly behind the right side of the window frame.

On the east wall next to the corner of the outbuilding a doorway accesses Bay 7.

#### Bay 7:-

From the corner of the outbuilding a stone and mortar wall, surviving to 3 feet (92cm.), runs parallel to the north-east wall of Bay 4, turns perpendicularly and closes the bay by butting



against Bay 4, where its inner face is 60cm from the outside of Bay 3. The surviving height of this wall may have been the intended finished height.

The doorway from Bay 6 has a concrete threshold. Three nails project 6cm from the brickwork, above the 4<sup>th</sup> brick, above 6<sup>th</sup>, and above 9<sup>th</sup>. Remnants of the wooden jamb still adhere to one.

A sunken drainage channel runs diagonally across the yard. It emerges from under the south-east wall, 14cm wide and 1.35m from the outside wall of Bay 4. It leaves by turning into a glazed pipe, held in brick and cement, 43cm from the brick wall and 25cm from the outside of Bay 4. The pipe has an internal diameter of 4 inches and a collar of 6 inches, and is laid parallel to Bay 4. The channel has a flat bottom of broken tile and cement, and vertical sides, and is 16-17cm wide as it approaches the pipe. Two iron plates have been placed over the channel: the larger is 167 x 67cm (This appears to be a re-use of waste material.) The floor on either side of the channel is boulder clay, but next the north-east wall a strip of quarry tiles, 3 wide, have been laid on the clay. Every tile is cracked.

In the east corner of the yard is a solid brick structure, 60cm wide south-west to north-east, 1 m. south-east to north-west, which appears to have been a flight of steps out of the yard. The outside ground seems to have been level with the top of the wall. (Recent spoil has been deposited here.)

On top of the south-east wall at the south-west end and against the wall of Bay 3 a concrete water chute has been formed. It is steeply inclined south-east to north-west and the invert level at the north-west is 1.13m above the clay floor. It is likely the purpose was to have carried rain water flowing from the roof.

*George Rutherford, Billy Dunlop and Ken Pulin*

As stated earlier the Griffith Valuation also known also as the Primary Valuation of Ireland was carried out in the townland of Carnanee on 25 March 1862 from which the records provide a snapshot of who occupied the various houses when the premises were surveyed at that date in time. Table 2 is an extract from the Carnanee Td Valuation published in 1862 in which it can be seen that the Paper Mill was given the map reference 4 which was then subdivided into 9 individual tenements labelled “a” through to “i” with a Tenent “Occupier” and “Immediate Lessor” identified for each.

No. and Letters of Reference to Map.	Names.		Description of Tenement.	Area.	Rateable Annual Valuation.		Total Annual Valuation of Rateable Property.
	Townlands and Occupiers.	Immediate Lessors.			Land.	Buildings.	
	<b>CARNANEE.</b> (Ord. S. 51.)			A. R. P.	£ s. d.	£ s. d.	£ s. d.
1	David Speare, . . .	William T. B. Lyons, . . .	House, offices, and land.	86 3 0	25 0 0	2 0 0	27 0 0
2	John Robinson, . . .	Same, . . .	House, office, and land.	25 3 20	14 10 0	1 5 0	15 15 0
3	Henry Gormall, . . .	Same, . . .	House, office, and land.	10 2 30	13 15 0	1 5 0	15 0 0
-	δ National School-house and garden, . . .	(See Exemptions.)					
4	α William Sloane, . . .	William T. B. Lyons, {	House, offices, and land, Paper-mill, stores, & offs.	84 0 0	77 10 0	0 0 0	131 10 0
-	β William Courtney, . . .	William Sloane, . . .	House and sm. garden.	-	-	1 10 0	
-	c George Todd, . . .	Same, . . .	House, . . .	-	-	0 15 0	0 15 0
-	d Joseph Rea, . . .	Same, . . .	House and sm. garden.	-	-	0 15 0	0 15 0
-	e Margaret Craig, . . .	Same, . . .	House and sm. garden.	-	-	0 15 0	0 15 0
-	f Unoccupied, . . .	Same, . . .	House, . . .	-	-	0 5 0	0 5 0
-	g Thomas Nutt, . . .	Same, . . .	House, . . .	-	-	0 15 0	0 15 0
-	h Samuel Courtney, . . .	Same, . . .	House, . . .	-	-	0 15 0	0 15 0
-	i James Barnett, . . .	Same, . . .	House, . . .	-	-	0 15 0	0 15 0
5	John Moore, . . .	William T. B. Lyons, . . .	Herd's ho., off., & land.	34 2 30	29 10 0	1 10 0	31 0 0

Table 2. extract – Griffith Primary Valuation table published 1862 (Ask about Ireland)

However the map provided with the rating table is not compatible with the map references in the table. The map issued in fact relates to a table contained in the First Revision of the Griffith Primary Valuation which was carried between 1864 and 1866.

Table 3 is an extract from the First Revision Record relating to map reference 4 shown in the published Valuation Map, fig 25.

VALUATION OF TENEMENTS PARISH OF BALLYMARTIN				
No. and Letters Of Reference to Map.	Names		Description of Tenement	
	Townlands and Names	Immediate Lessor		
CARNANEE (Ord. S. 51.)				
4A	a	Diamond & Steen <i>(from William Sloane 1864)</i>	William T. B. Lyons	House, Offices and Land Paper Mill, Stores and Offices
	b	Joseph Rea <i>(William Courtney)</i>	Diamond & Steen	House
	c	William Harper		House
	d	William Kilton <i>(George Todd)</i>		House
	e	John Harper <i>(Joseph Rea)</i>		House
4B		John Williamson	William T. B. Lyons	House
	a	Roger Hunter	John Williamson	House
	b	Thomas Nutt		House
	c	James Robinson <i>Samuel Courtney</i>		House
	d	<i>Vacant</i>		House
	e	Alexander <i>(James)</i> Burnet		House
	f	Thomas Horner		House

Table 3. extract from First Revision of the Primary Valuation taken in May 1864.  
(PRONI, Val/12/B/1/14A)

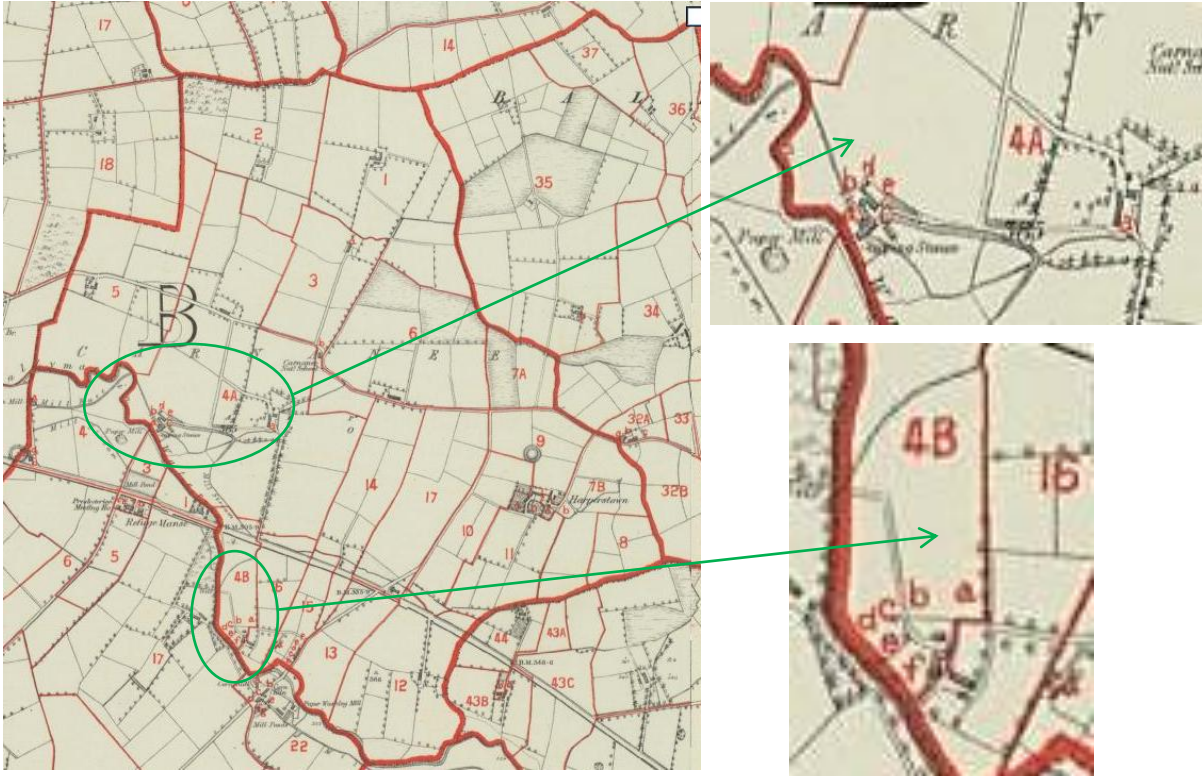

Fig. 25 Griffith Primary Valuation Map c1862-64 (Ask about Ireland)

The difference between the Griffith Valuation Map (fig. 25) and the Primary Valuation Rating Table (table 2) is that Table area 4 is not subdivided and accounts for only 9 tenements, whereas the map area 4 is shown to be made up of two distinct areas labelled 4A and 4B each in turn divided into individual tenements with 12 tenements in total having been identified.

What has clearly happened is that a Griffith Valuation Map was not issued at the same time of the release of the First Valuation Rating Table but rather some time later and in fact relates to the First Revision of the Primary Valuation with the revision having been carried out between 1864 and 1866, two years after Carnahee Td was first assessed in this scheme.

Given the extent and complexity of the Primary Valuation undertaken by Richard Griffith at the time then quick changes in ownership would have been difficult to cover completely. The timing of a change in ownership of the Paper Mill from William Sloane to Diamond & Steen in the years 1862 to 1864 would likely have played a part in the records not being able to reflect what was a changing situation. Table 3 would suggest that things were indeed changing quickly.

In explaining the differences between tables 2 and 3 it would appear that Diamond & Steen were only interested in the Paper Mill and those houses directly associated with the mill. This company appears to have passed Tenements "4f", "4g", "4h" and "4i" back to the William T.B.

Lyons who was Sloane's *Immediate Lessor* who subsequently re-let this parcel of land with houses to John Williamson. John Williamson held one house and sublet to six rather than four other individuals identified as tenements "4B a" to "4Bf" in the Griffith Map and the 1864 First Revision Table as above.

Compatibility between the Griffith Primary Valuations Rating tables and the accompanying reference Maps seems to have been an issue when the resulting Valuation Rates were being issued for publication. A further example of this type of departure was observed and noted in the UAS Divis Farm, Belfast, Report published in 2013 (McDonald, Catney, UAS/10/03). However, in that particular case the reverse situation was identified in that the Map was out of date when the Primary Valuation Rating Table was published in 1862. The map identified 5 tenement map areas but in the Rating Table only 4 areas were shown to have attracted a due rate. One small holding had in the meantime been handed back to the Immediate Lessor before the Valuation took place, consequently, the published map was not a valid record in 1862.

In chapter VII "*A dose of assimilation*" of his book "*A Paper Landscape*" J. H. Andrews deals with the effects that changes such as at Divis and Carnanee had had on mapping from 1854 to 1898 wherein he shows that these were not rare occurrences at that time. (Andrews, 2002, 244-283

Ordnance survey maps indicate that the cottages fell into ruin sometime between 1961 and 1977. Indeed, Hazel Patterson, recently recalled that the last occupants of the cottages were, Hugh Ingram, whom she mentioned was "*shell shocked and house bound*" and his brother Jim Ingram who "*hired himself out to local farmers*". They apparently vacated the cottages in about 1962.

Following the death of Robert Patterson in 1990 the Patterson family put the mill up for sale. The National Trust took possession of the mill in 1992 and opened it to the public in 1994.

## 6. Post Script

In 1980 the present Patterson's Spade Mill Manager, Colin Dawson, decided to learn the skills involved in traditional spade making and to that end he offered, on a voluntary basis, to assist the last spade maker Robert Patterson. Over the ten year period up until Robert's death in 1990 Colin not only acquired the techniques involved in spade making but he also got to know the intricate sequences involved in operating the Carnanee Spade Mill. After taking over the mill in 1992 the National Trust sent Colin on a top-up course to Chiefton Forge mill in Scotland, a mill which has since closed. Colin has now been joined by a fellow spade maker, Tom Mahon, which not only keeps the Patterson's Traditional Spade Mill operating but also means that the long tradition of spade makers passing on their knowledge and experience of this particular craft to successive generations remains unbroken with the line going back to the 18<sup>th</sup> century and seems set to continue.

With the foresight and input by the National Trust an important part of the industrial heritage of Northern Ireland has been preserved in a living form for the present and future generations to visit and experience.

The Patterson's Spade Mill [NT] is the sole surviving traditional spade mill currently in daily use in the British Isles.

## Bibliography.

- Andrews, J.H. 2002, *A Paper Landscape*, Dublin, 244-283
- Bardon, J, 1995, *BELFAST, An Illustrated History*, Belfast, 66
- Carl M Becker , ‘ James Leffel: Double Turbine Water Wheel Inventor’ , Ohio Historical Society Journal, 75, 4 (1966), 200-210.
- Coulter, Michael D.A, 1995, *Patterson’s Spade Mill*, Industrial Arch Review Vol.18 No.1, 96
- Day, A, Williams, P, 1990, *Ordnance Survey MEMOIRS OF IRELAND, PARISHES OF COUNTY ANTRIM 1, 1838-39, Vol. 2*, Dublin, 16
- Fairbairn, William, 1864, *Treatise on MILLS AND MILLWORK, PART 1*, London, 166  
 - 1865, *Treatise on MILLS AND MILLWORK, PART 2*, London, 239-251
- McCutcheon, W.A., 1980, *The industrial archaeology of Northern Ireland*, Belfast, 258
- Oxford Companion to Irish History, S.J. Connolly ed., 2011, *paper manufacturing*, Oxford, 449
- Reynolds, T.S. 1983, *Stronger Than A Hundred Men* The John Hopkins University Press, Baltimore, USA., 4

### PUBLIC RECORDS OFFICE OF NORTHERN IRELAND documents:-

- D835/1 – Maps relating to the Earl of Donegall’s estates:  
 James Crow map 1767 – 1779.
- Val/1/B – Family Tree, Series 4, Valuation Records :-  
 Townland Valuation.
- Val/1/B/113. Valuation Field Books:- Barony of Belfast Lower. Parish of Ballymartin.
- VAL/2/B. Griffith Valuations Field Books – , Co. Antrim, including Parish of Ballymartin: Val/2/B/1/11. 1862
- Val/12/B/1/14A Valuation Revision Books:- Carnanee, Co. Antrim, Ballymartin, 1864 - 1866.
- Val/13/2. INSTRUCTIONS TO THE VALUATORS, APPOINTED UNDER THE 6<sup>th</sup> & 7<sup>th</sup> William IV CAP 84, for the UNIFORM VALUATION OF LAND AND TENEMENTS in IRELAND, Dublin 1839”.
- Val/13/4 Instructions to Valuators, 1853.

### Web pages:-

*Ask about Ireland:-*

<http://askaboutireland.ie/griffith-valuation/index.xml?action=placeSearch>

last viewed 20 September 2013.

Illustrated hand book of James Leffel’s improved double turbine water wheel for 1885 and 1886.  
 – Open Library:

[http://openlibrary.org/books/OL14014208M/Illustrated\\_hand\\_book\\_of\\_James\\_Leffel%27s\\_improved\\_double\\_turbine\\_water\\_wheel\\_for\\_1885\\_and\\_1886](http://openlibrary.org/books/OL14014208M/Illustrated_hand_book_of_James_Leffel%27s_improved_double_turbine_water_wheel_for_1885_and_1886). Last viewed 13 September 2013.

Wikipedia. *Francis Turbine*, last viewed 13 September 2013.

## Appendix 1.

**Waterwheel Power Calculations: example** (PRONI, Val/13/4, 1853, p64)  
*(method as per Book of Instructions to Valuators, 1853)*

Mill type:-	1836 (Valuation)		1838 (Memoir)		1862 (Valuation)	
	Flax	Corn	Paper Mill		Paper Mill	
	VI					
1. Type of Wheel	Breast		<i>Breast</i>	<i>Breast</i>	<i>Breast*</i>	<i>Breast**</i>
2. Velocity of Wheel - rpm	6.6		unknown	unknown	---	1
3. Diameter of Wheel - ft	14		14	25	10	14
4. Breadth of Wheel - ft	4		1ft 4"	6	4	4
5. Depth of Shroud - ft (not recorded)	0.708					
(inches)	8.5					
Mean Circumference of Buckets - ft	41.76					
Total Cubic Capacity of Buckets - cu. ft	118.3					
Total Cubic Capacity expended - cu. ft.	781					
Assume Buckets are only Half filled - cu. Ft.	390.5					
Total Weight of Water expended- lbs @ 62.5 lbs/cu. ft	24405					
Fall of Water	12		18	25		25 ***
Power of Water -HP @33000 lbf ft/min	8.87					32.96
Water Wheel Efficiency %	66					66 ***
Horsepower	5.9	5.00	6.00	unknown	unknown	unknown unknown 21.8

**Declared Useful hp. About 22hp**

NB:-

Values in RED are values given in the Memoirs (1838) or Valuation returns (1862) –  
 - all other values are applied values in keeping with the example given in the Valuators Instructions Book.

Readings in rows 1 to 5 above were to be recorded by the Valuators on inspection of premises

VI:- is the Valuators Instructions example. (PRONI, Val/13/4, 1853, 64 )

\* 10ftx4ft waterwheel (not tested in 1862) may have driven the Corn Mill in 1836.

\*\* 14ftx4ft wheel recorded in 1862 – Tested but “not used”. Possibly used to power the Flax Mill in 1836.

The Fall of Water taken for the three wheels are as follows:

25ft Wheel :

Fall – 25ft as mentioned in Memoirs and value to give about 22hp as per 1962 Valuation Return

14ft: Wheel:

Fall – 12ft due to the elevated position and the close proximity of the Flax Mill to the Mill pond . 12ft would be the most likely maximum fall available in this case.

10ft: Wheel:

Fall – 18ft, assuming that this wheel had the same axle level as the 25ft wheel that replaced it in 1836/37 this would give a fall of 17.5ft rounded up to 18ft

### Appendix 2.

23  
26 March 1862

Townland of Carnaseel Ord. S. No. 51

d.	Rent and Tenure.	Reputed Area of Tenement. A. R. P.	MEASUREMENTS OF BUILDINGS.										OBSERVATIONS.		
			Form of Buildings.	Length in Yards.	Breadth in Yards.	Height in Stories.	Quality.	Area in Square Feet.	Price per Acre.	Value.	Value.	Value.			
0	24.0.0	21.2.0													7.2.0 10/6 3.18.9 ✓ 3.0.0 17/ 1.16.0 ✓ 11.2.0 15/ 8.12.6 ✓ 12.2.0 14/ 1.16.0 ✓ 12.2.0 13/ 8.2.6 ✓ 36.3.0 2/3 26.5.9 2.8.7 26.14.9 7.2.0 10/6 3.18.9 ✓ 3.0.0 15/ 15.0 ✓ 15.3.25 12/6 12.11.3 ✓ 12 25.3.20 15.5.9 1.10.6 16.35.6 3.2.0 14/ 2.9.0 ✓ 15.2.30 1/2 7.16.0 ✓ 19.2.30 12.5.0 1.4.6 13.9.6
0	14.0.0	15.0.0													16 15 ✓ 12 25.3.20 15.5.9 1.10.6 16.35.6 3.2.0 14/ 2.9.0 ✓ 15.2.30 1/2 7.16.0 ✓ 19.2.30 12.5.0 1.4.6 13.9.6
0	12.12.0	12.0.0													15 ✓ 9 10
0	Free	Ex													9 15 ✓ school house exempt
0	89.0.0	83.0.35	He. St.	13 1/2	8 2 B										86 0 0 30 3 Water wheels * 1.6 25 feet Diam. Bunkis 6 ft 10 2.0 14 * mill 4 ft 3 10 " " 4 ft No steam engine 1-10-0 2 7 1/2 10 10.4.0 20 20 20 20.0.0 47 22 1/2 88.15.0 88.14.0 * 4 revolutions 1/2 minute * 4 revolutions in 1/4 minute * 10 1/2 revolutions 1.0.30 6.0.0 17/ 3.12.0 ✓ 18.0.0 14/6 13.1.0 ✓ 14.0.0 18/6 10.7.0 ✓ 20.0.0 25/ 12.10.0 ✓ 34.3.10 20/ 34.16.0 ✓ 74.16 7 9.7 82.5.7
0			mill	35	5 1 C										
0			Eng. Store	28	5 1/2 2 B										
0			Engine room	28	5 1/2 2 B										
0			Steam Boiler Ho.	8	5 1 B										
0			Machine room	22	8 1 B										
0			Work Shop cont. Ho	8	7 2 B										

Griffith Valuation Return of 25 March 1862. (PRONI, Val/2/B/1/11)



### Appendix 3

#### PHOTOGRAPH RECORD FORM

**Site** *Patterson's Spade Mill*

**Date** DSC6536 to DSC6671 – 28 Aug 2010: DSC6947 to DSC6694 -29 Sept 2010

Film no.	B/W Print	Colour print	Colour slide	Digital image (m.pixels)

**Make and model of camera** *NIKON D700 -12.1 megapixel digital camera*

Frame no	Direction viewed from	Details
DSC6536	East	Leffel Turbine in Tail-race pit
DSC6537	to DSC 6581	Artefacts found during survey
DSC6582 & DSC6670	NE	Restored Cottage identified in Griffith map as "4d" - fig. 23 in this Report
DSC6583	to DSC 6636/40	Various photographs of cottage ruins
DSC6649	to DSC 6662	Spade making demonstration
DSC6663	to DSC 6667	Spade Mill interior
DSC6668	NW	Spade Mill weir
DSC6671	above	Corn Mill – mill stone
-----	-----	-----
DSC6947	South	Cottage ruins
DSC6948	East	Ruins of Beetling Mill
DSC6950	NW	Mill Pond and Sluice Gate
DSC6952	East	Flume
DSC6954	East	Inside Bay 1

DSC6963	NE	Inside Bay 3 looking out – note cobbled floor
DSC6969	NE	Inside Bay 5 looking out
DSC6970	SE	Inside Bay 4 towards Bay 5
DSC6971	West	Inside Bay 4 towards Bay 6
DSC6973	East	Inside Bay 5 looking out towards Beetling Mill ruins
DSC6979	SE	Inside Bay 7 towards Bays 6 & 7 dividing wall
DSC6994	from above	Earthenware pipe in floor of Bay 7
Make and model of camera:- Samsung Galaxy S2, GT-I9100p 8 megapixel		
GT-I9100. 1	SE	View of South wall of the Corn Mill with arched window
GT-I9100. 2	SE	Single story roofed Paper Mill Machine Room facing east